

Double Pinwheel Fabric Postcard

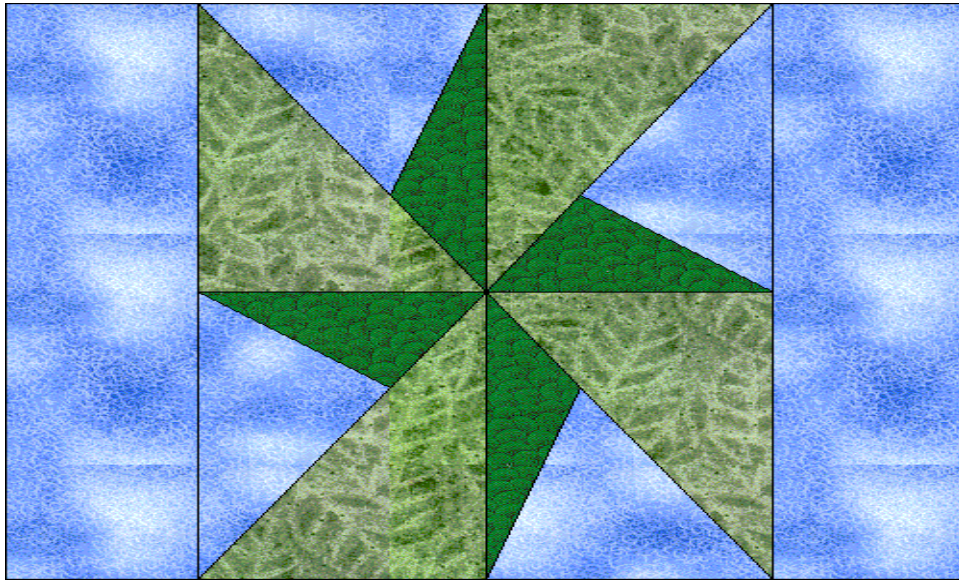

Double Pinwheel Fabric Postcard
Pattern for 5.00x3.00 block
Key Block (69/100 actual size)

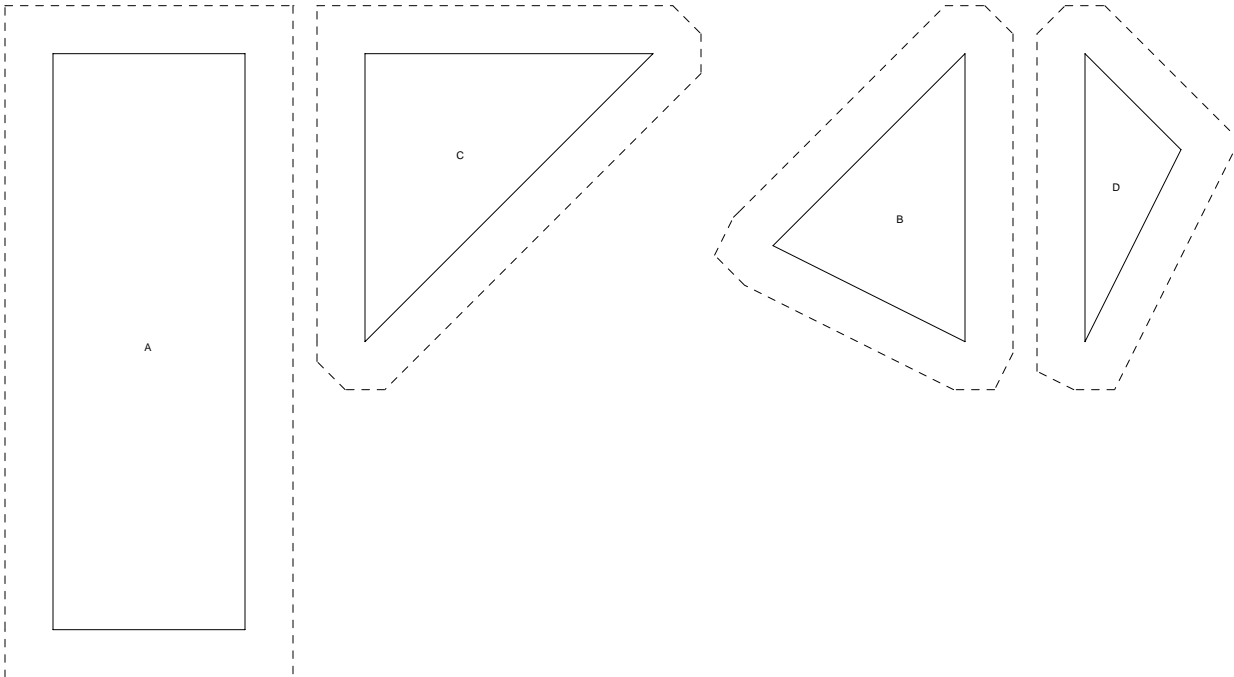

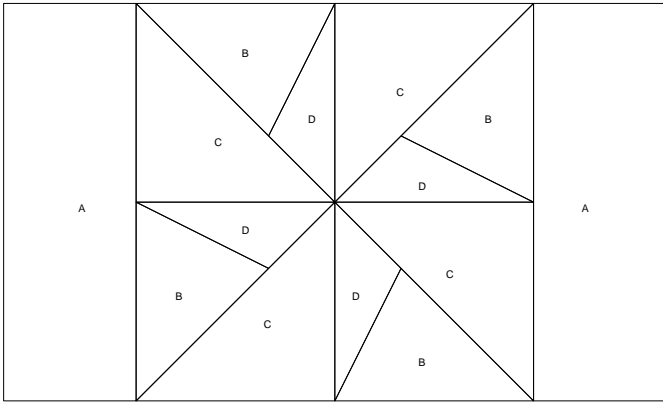
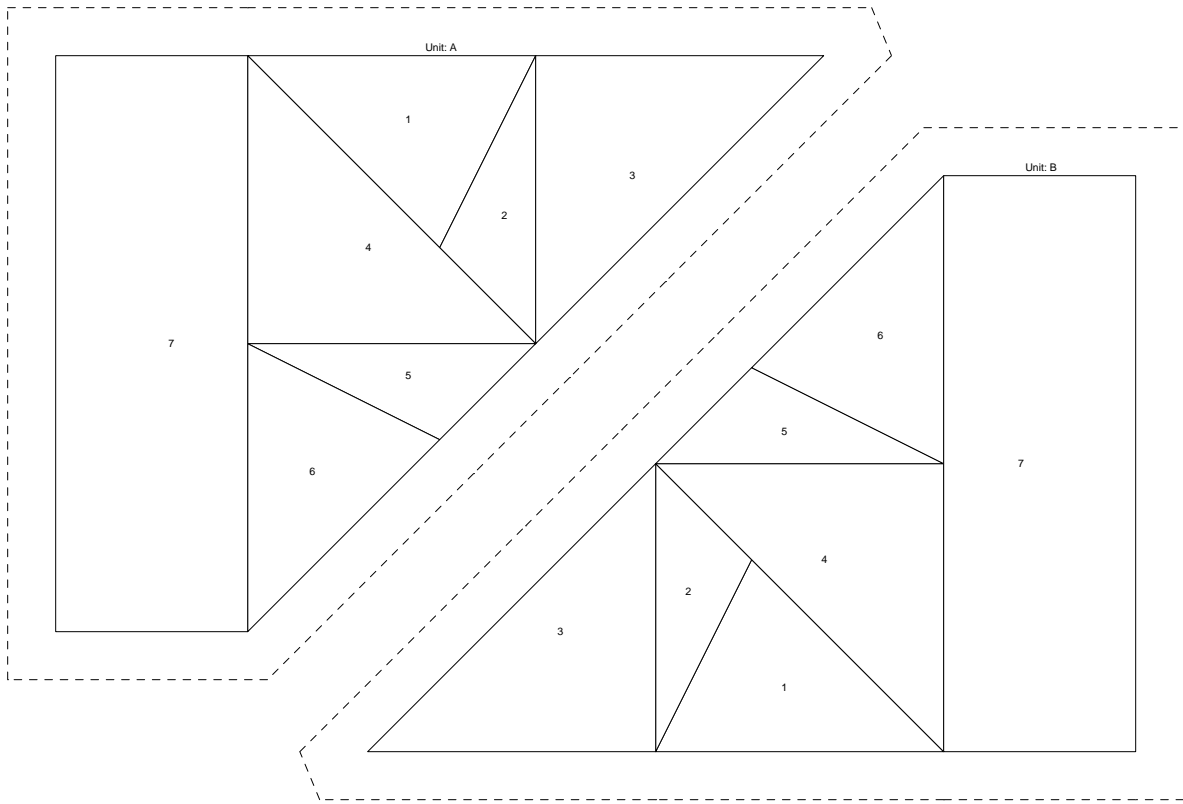

Double Pinwheel Fabric Postcard

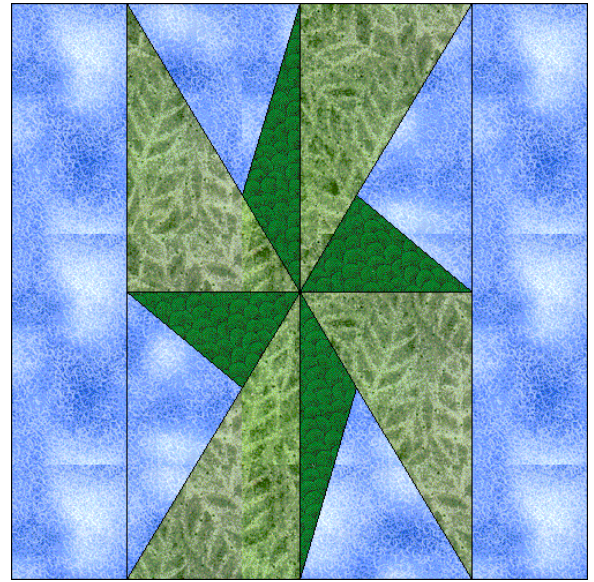
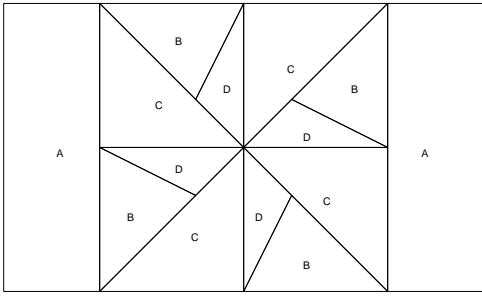

Cutting Diagrams

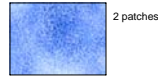

Patch Count

2 patches

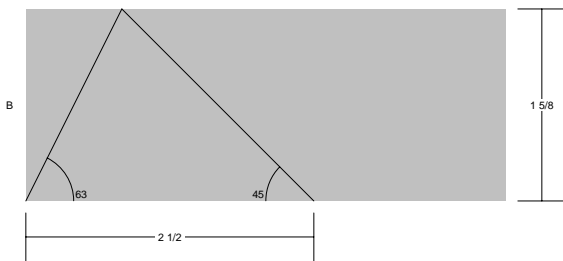

4 patches

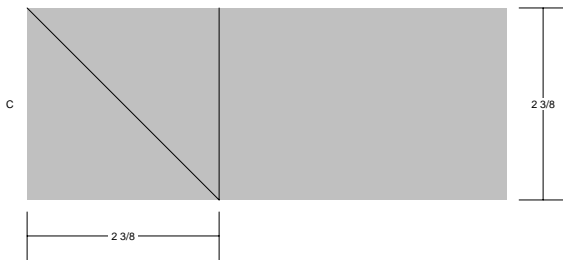

4 patches

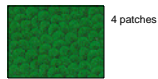
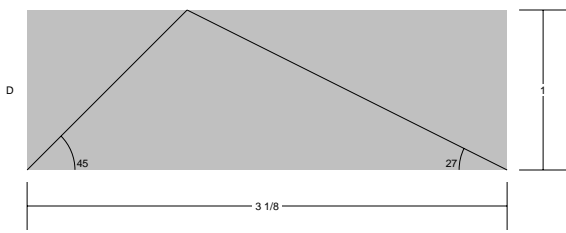

Color Variations for Double Pinwheel
Fabric Postcards

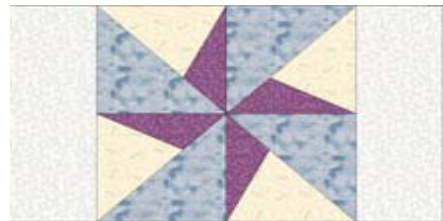
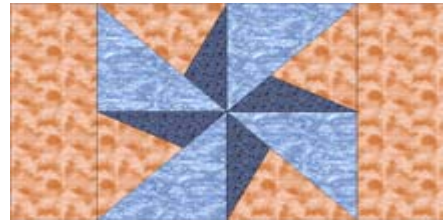
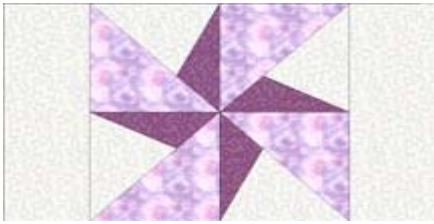

Double Pinwheel Whirls

6" quilt block

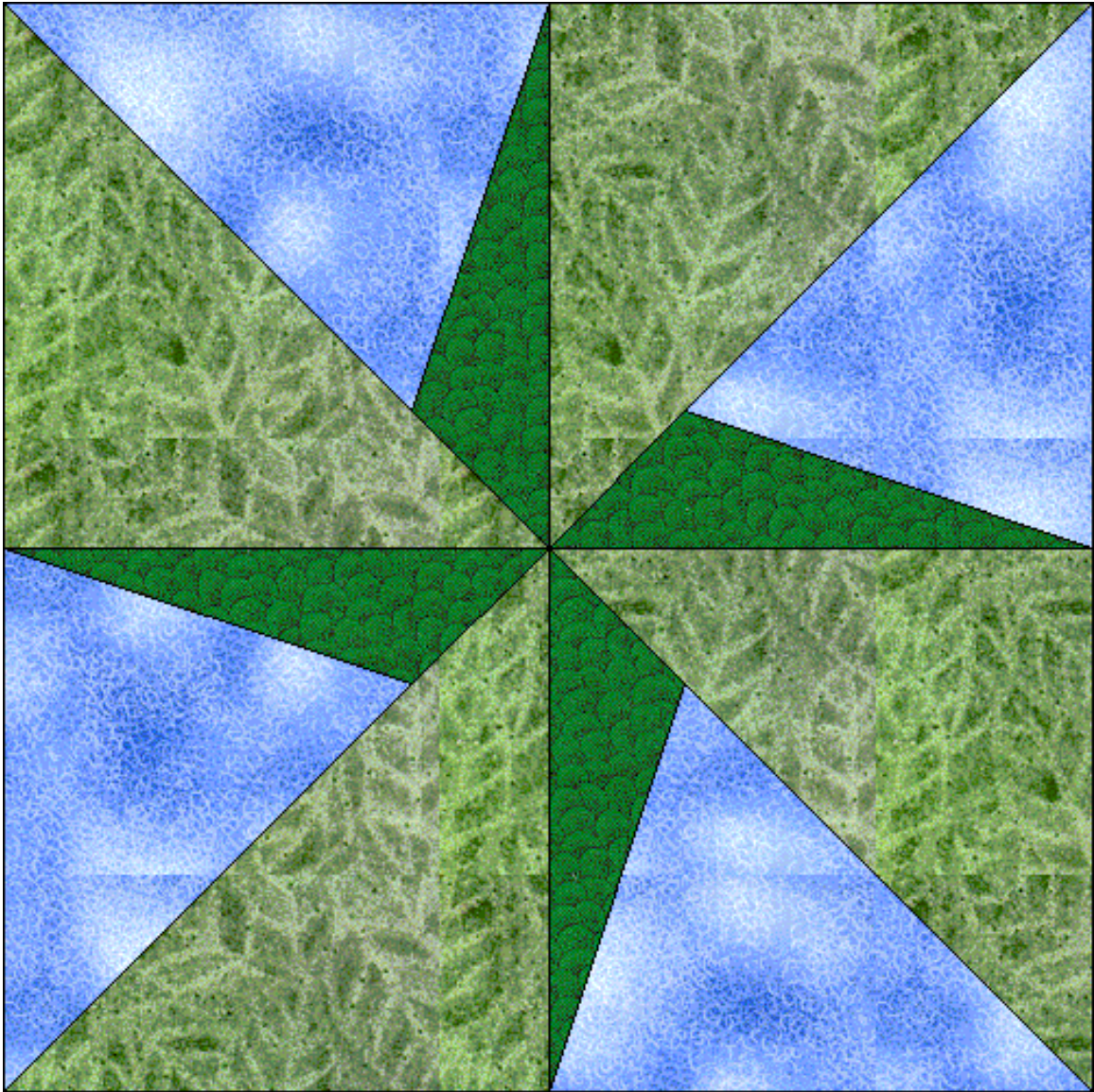

Double Pinwheel Whirls

Pattern for 6.00x6.00 block
Key Block (29/50 actual size)

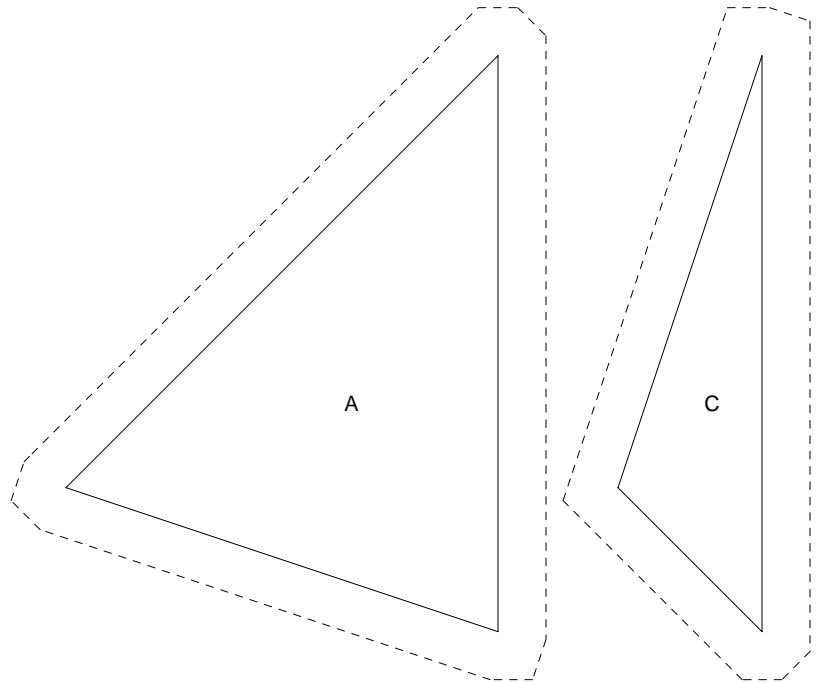
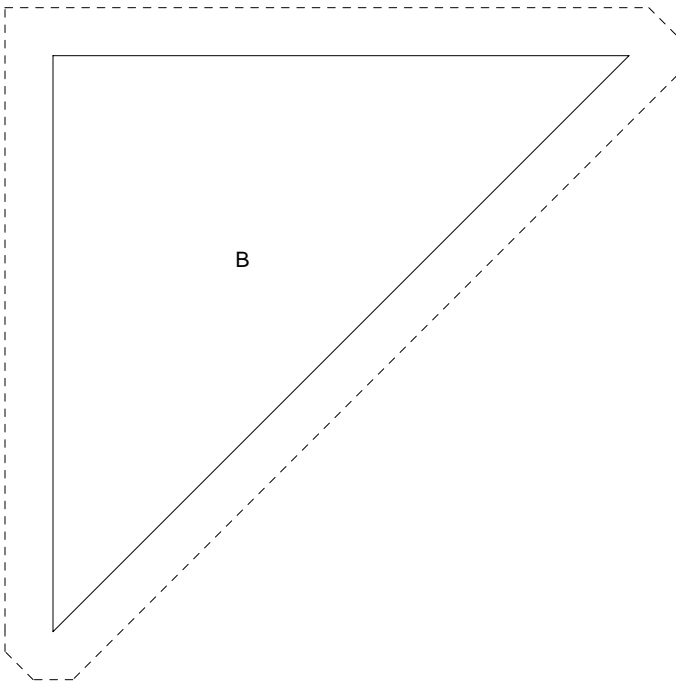
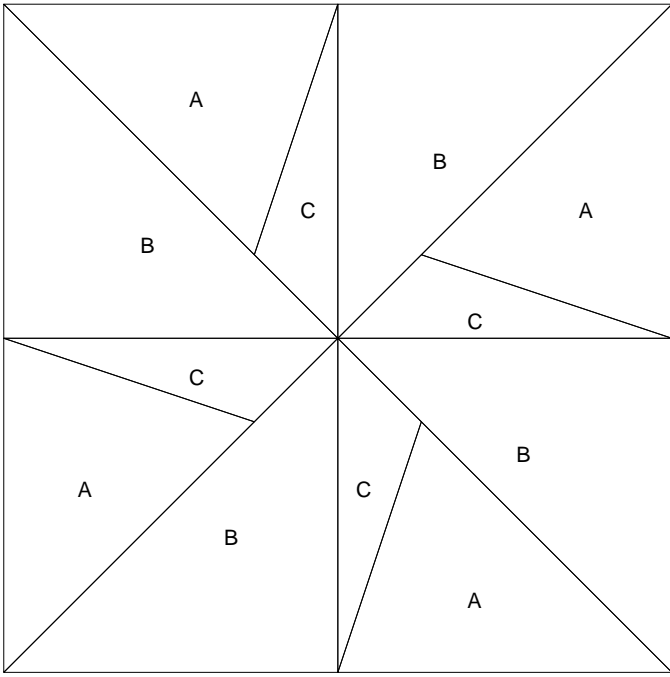

Double Pinwheel Whirls

Pattern for 6.00x6.00 block
Key Block (41/100 actual size)

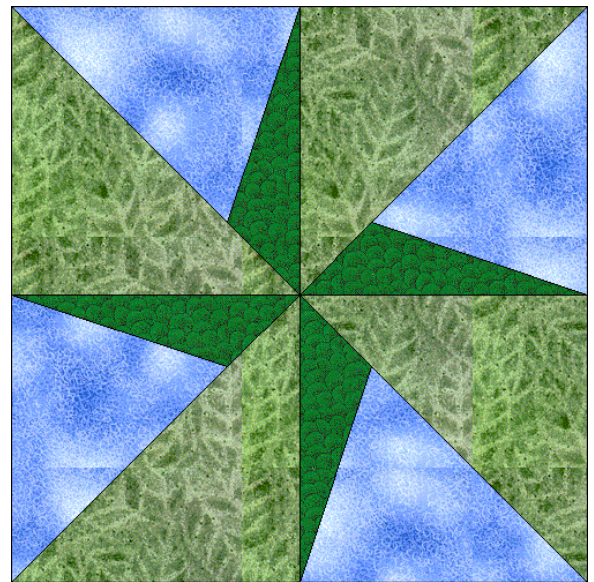
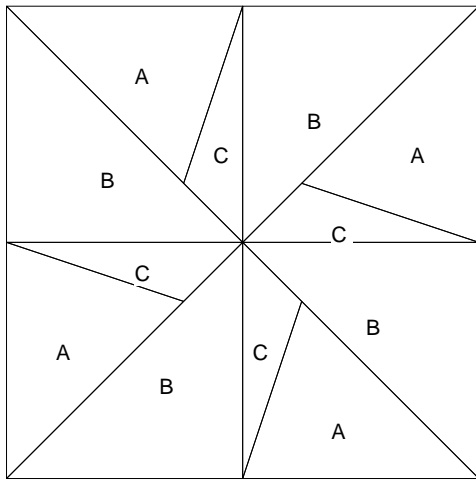

Cutting Diagrams

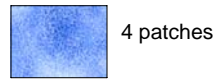
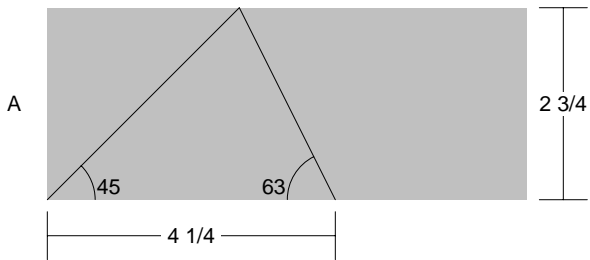

Patch Count

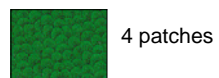
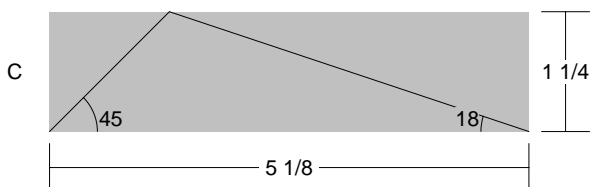
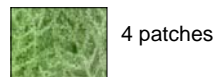
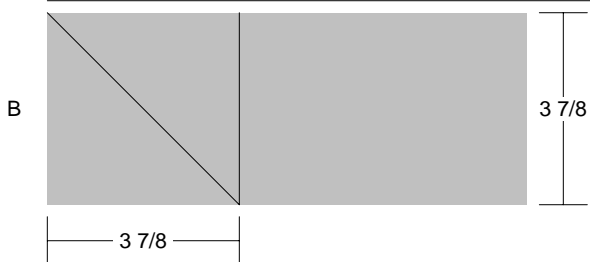

US Flag Paper Pieced Fabric Postcard



Greetings, Quilter Friends!

Thank you very much for participating in the effort to gather fabric postcards and send them to the troops in the Middle East. We know the men and women will be touched and most pleased by our efforts.

On the following pages you will find pictures of the process for making the US Flag Paper Pieced Postcard using the pattern in this package. Sorry, I didn't have time to give you complete instructions, but like they say, "A picture is worth a thousand words."

In the cases where the picture doesn't tell the story, I have included a comment or two. I hope that is helpful.

When you have finished your fabric postcard(s), please place them in an envelope and mail them to us at:

How to Quilt
9080 Murray Drive
La Mesa, CA 91942

Also, enclose a picture of yourself, if you would like that posted on the website with the picture of your fabric postcard.

If you have any questions, please feel free to call (619) 697-6667 or fax (619) 303-3339 or email info@how-to-quilt.com. We are here to help in any way we can.

Please your family, friends, quilting buddies, people on the street, whoever you meet about this project. The more fabric postcards we get, the more soldiers will receive them. Let's make a huge impact across the globe!

If you have ideas for getting the word out, please let us know, and we'll do everything we can to follow up or send materials.

Happy Quilting!



Penny Halgren

www.How-to-Quilt.com

Inspiration and Education for Beginning Quilters

www.Rag-Quilt-Instructions.com

Fast, Fun and Funky Quilts

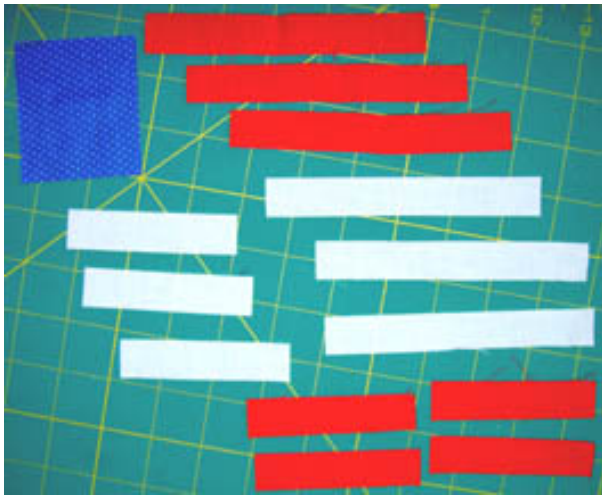

Cut fabric pieces

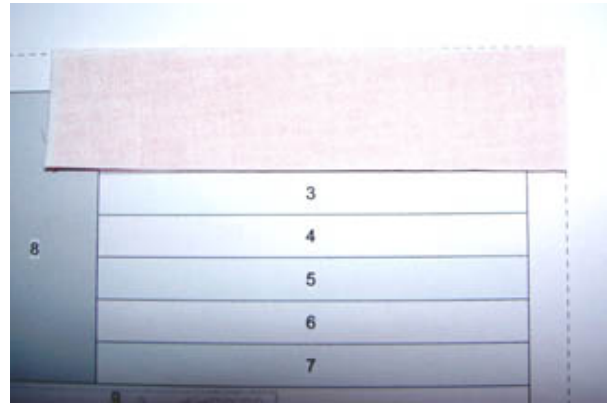

Place 1 red strip & 1 white strip right sides together

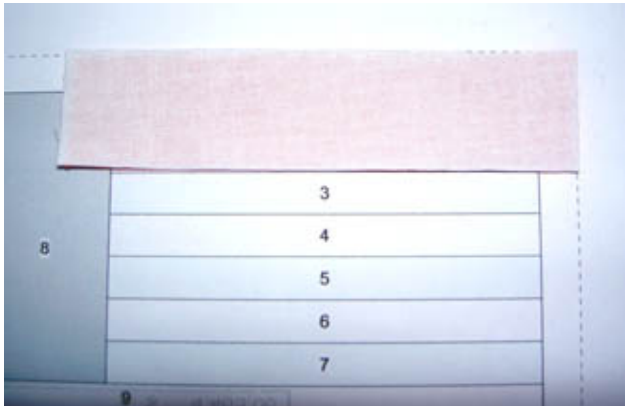

Line up the strips on the sewing line

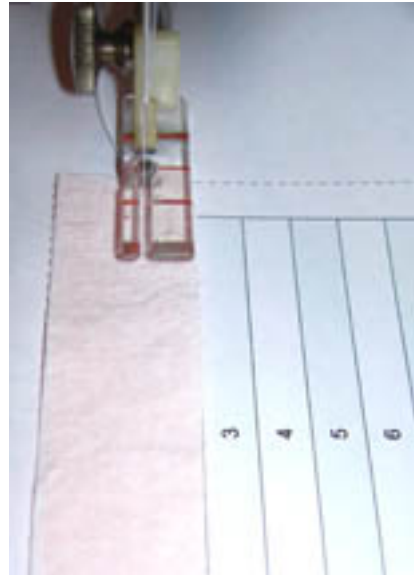

Sew at the bottom of the first stripe, using a $\frac{1}{4}$ " seam allowance

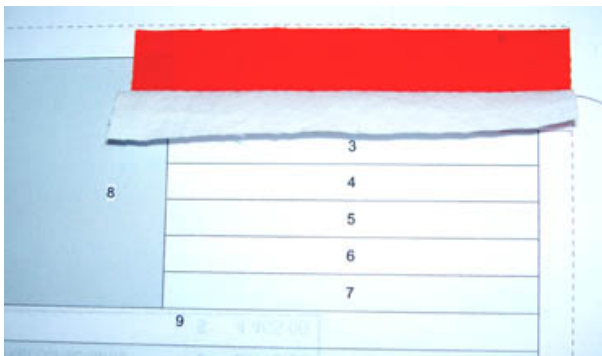

Fold down the second stripe

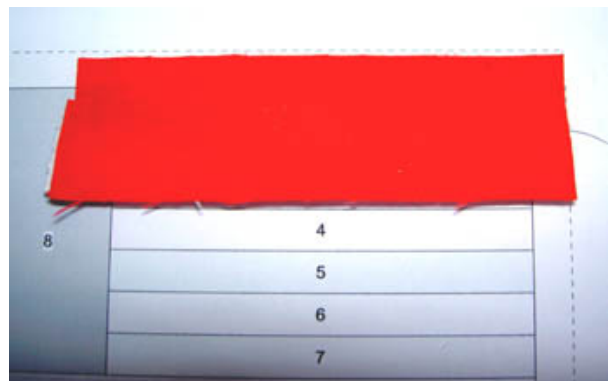

Place the third stripe on top of the second, right sides together



Sew the third stripe



Fold down the third stripe



You could sew the stripes from the back. It's a little difficult to see the lines, but it might be a little easier to sew.

Continue to add stripes until you have all of the short stripes attached

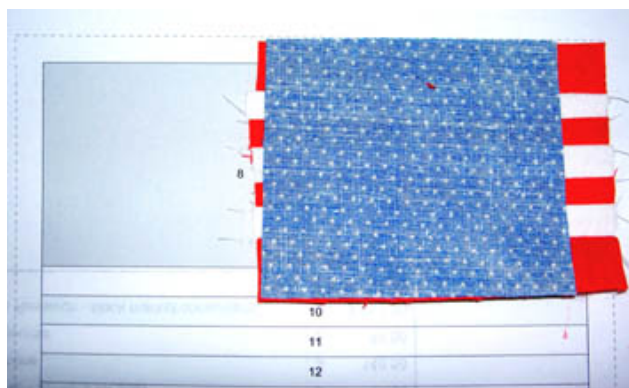

Place the star section on top of the stripes



Sew the star section to the stripes



Fold open the star section



Place the first long stripe, right sides together



Fold down the first long stripe



Sew the second long stripe and fold down



Continue to sew stripes until they are all in place

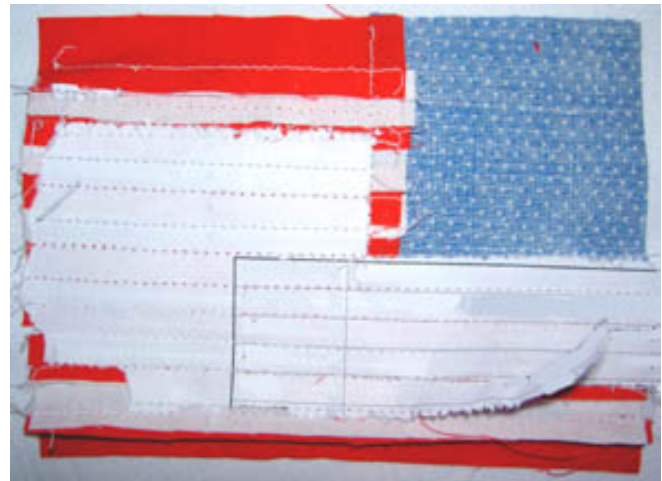

Tear the paper away from the back



All of the paper is torn off

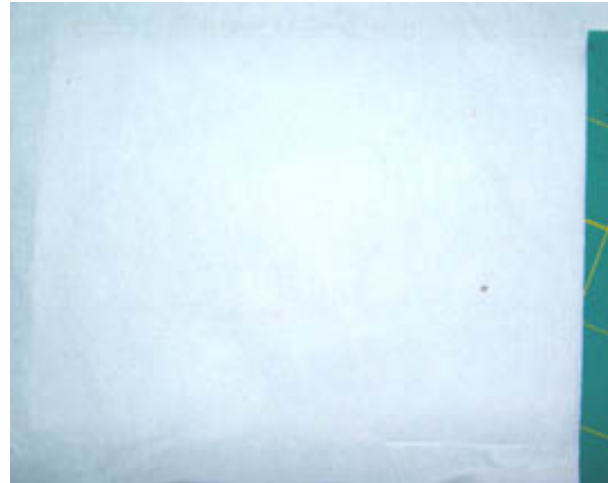

Measure a piece of lightweight interfacing and the fabric that will be the back of your postcard



Press the interfacing to the backing fabric



Press the top



Measure the back fabric



Trim the edges of the flag top to make them even on all sides



Your flag top and back are all the same size and edges are trimmed



I used double fold bias tape – store bought. Sew the tape until you reach ¼” away from the corner. Remove the quilt top from your machine and fold the bias tape up at a 45° angle as shown above. Note: I began at the center of the bottom of the postcard. And I folded the starting end over by ¼” to make a nice overlap. You will see in the picture below.



Fold down the corner to begin sewing the next side. Continue sewing and turning until all 4 sides are done.



This is the end. Sew new piece on top of the first bias tape you sewed.

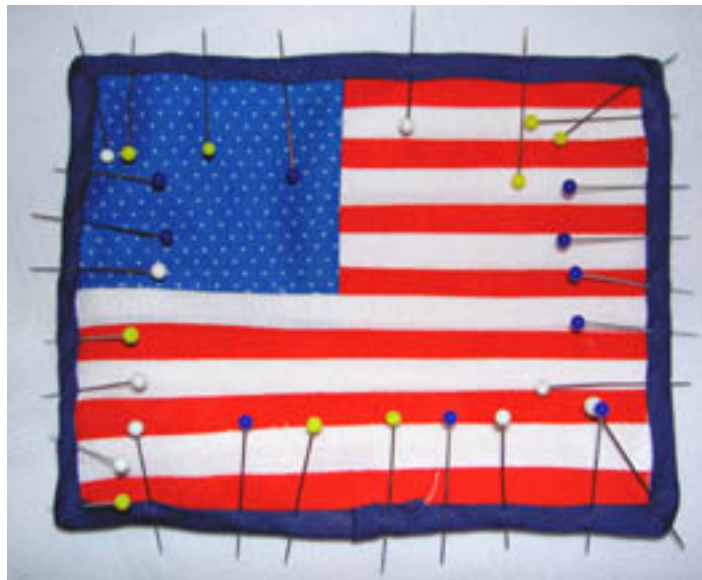

Fold the bias tape over to the front of the fabric postcard and pin well. You will be sewing from front to back. I changed the color of my top thread to blue to match the top, and left the bottom thread white, since my back is white.



Finished!



I left the back completely blank for my message.

US Flag Paper Pieced Pattern

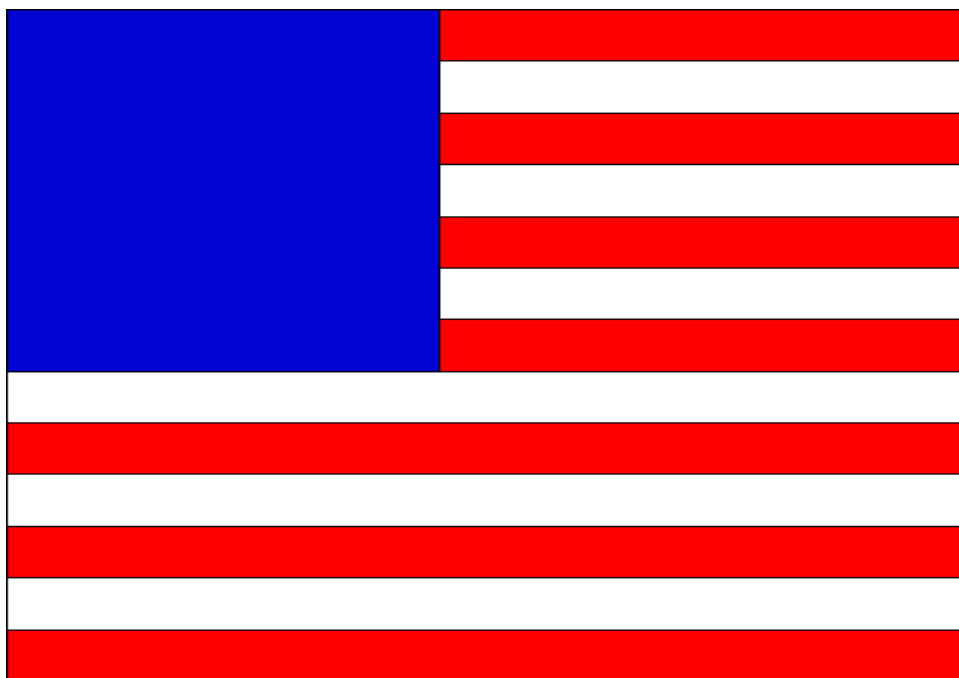

Worktable Block
Pattern for 5.00x3.50 block
Key Block (69/100 actual size)

A	B
	B
	B
	B
	B
	B
	B
	B
C	
C	
C	
C	
C	
C	
C	

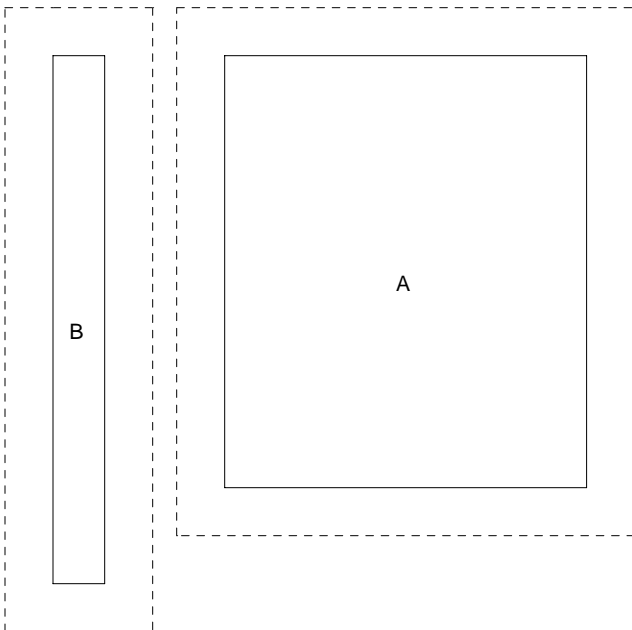

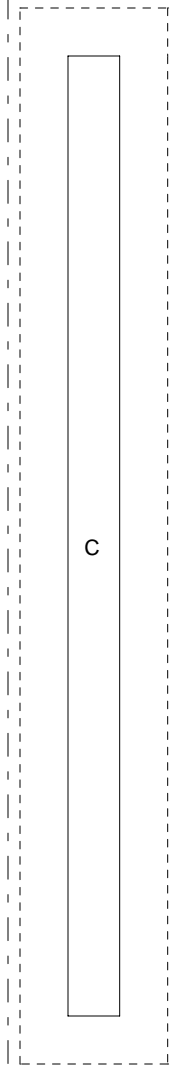

C

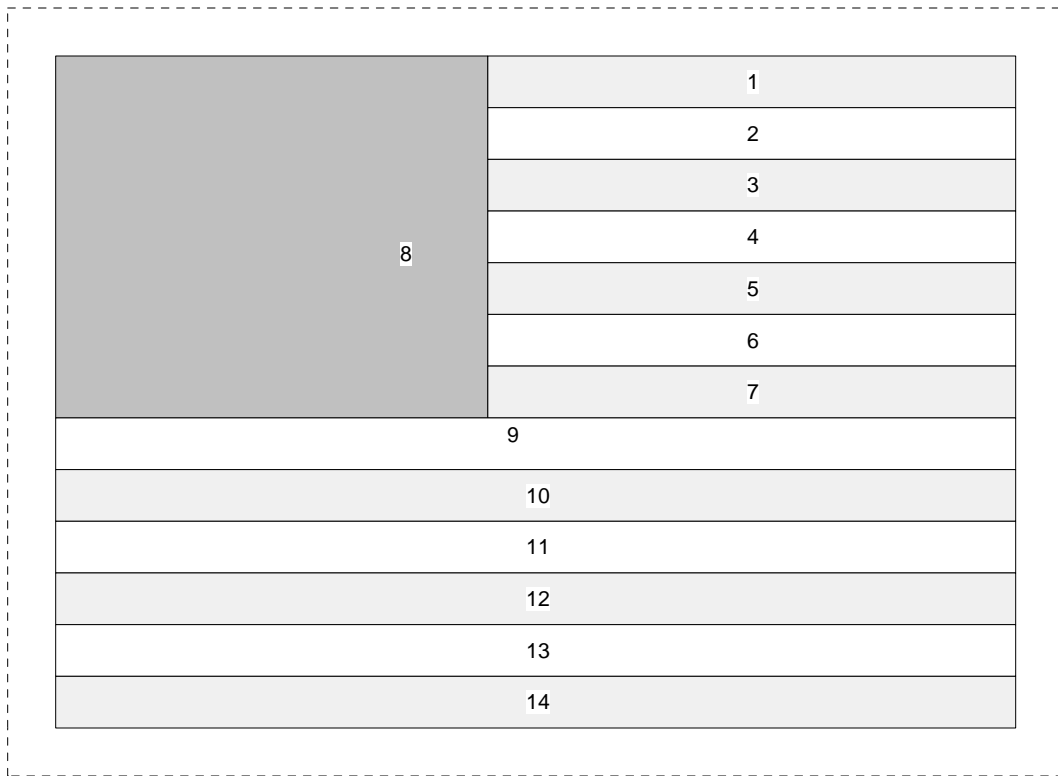

Worktable Block
 Pattern for 5.00x3.50 block
 Key Block (1/2 actual size)

A	B
	B
	B
	B
	B
	B
	B
	B
C	
C	
C	
C	
C	
C	

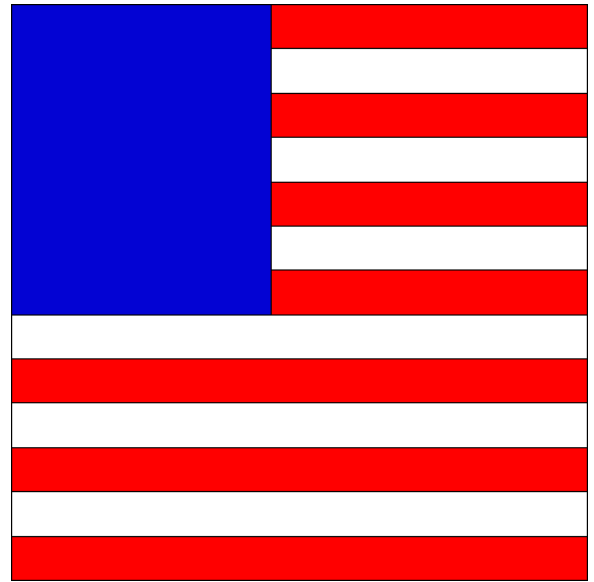

Cutting Diagrams



Patch Count

