

# March 2010 Block Patterns

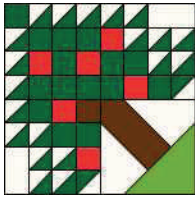

Apple Tree

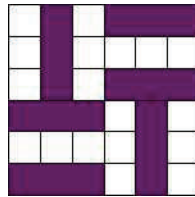

Basket Weave

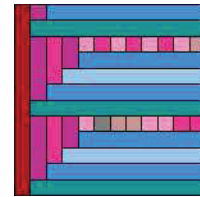

Chimneys and Cornerstones

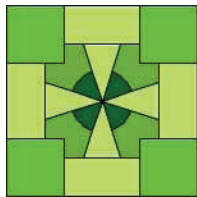

Four Leaf Clover

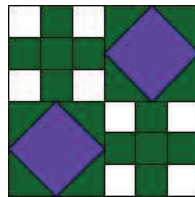

Goose Creek

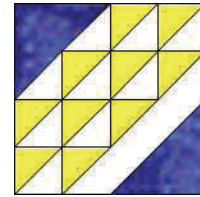

Migration

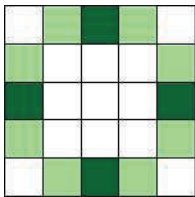

Multiple Squares

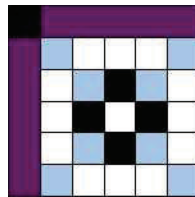

Nine Patch Plaid

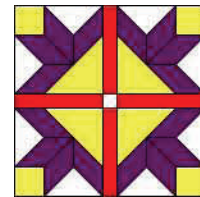

Pieced Tulips Block

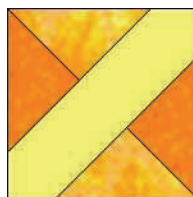

Signature

Apple Tree

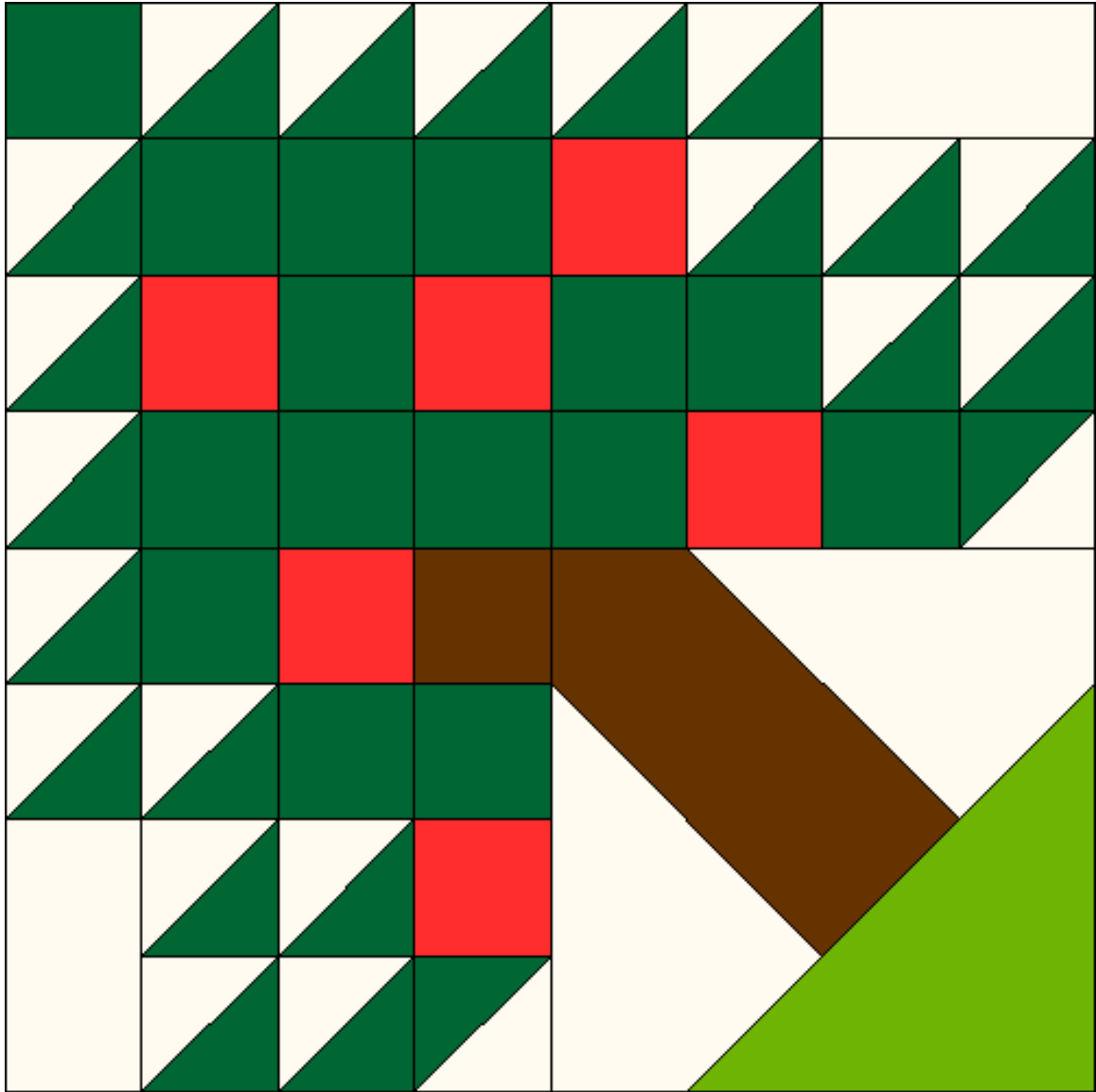

Apple Tree  
 Pattern for 8.00x8.00 block  
 Key Block (43/100 actual size)

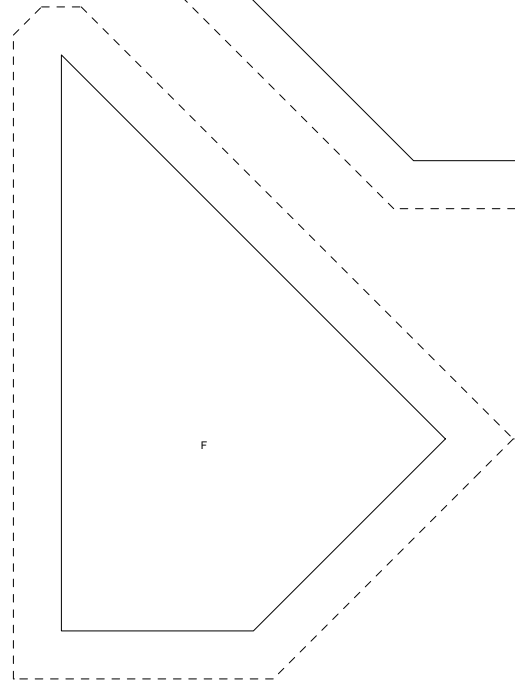
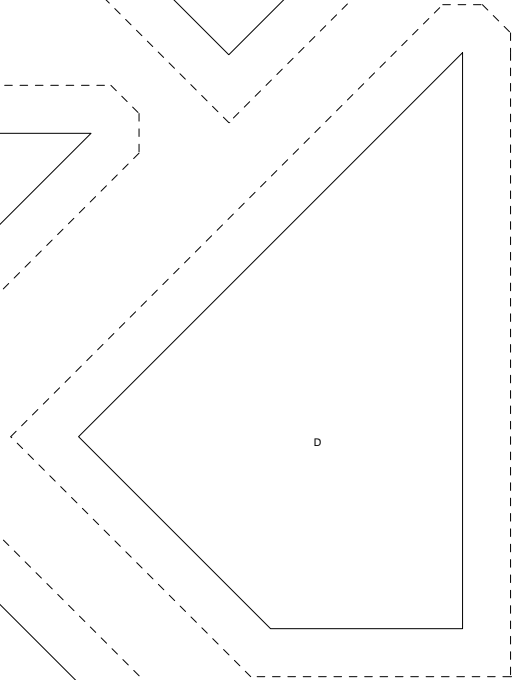
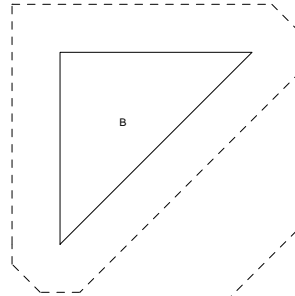
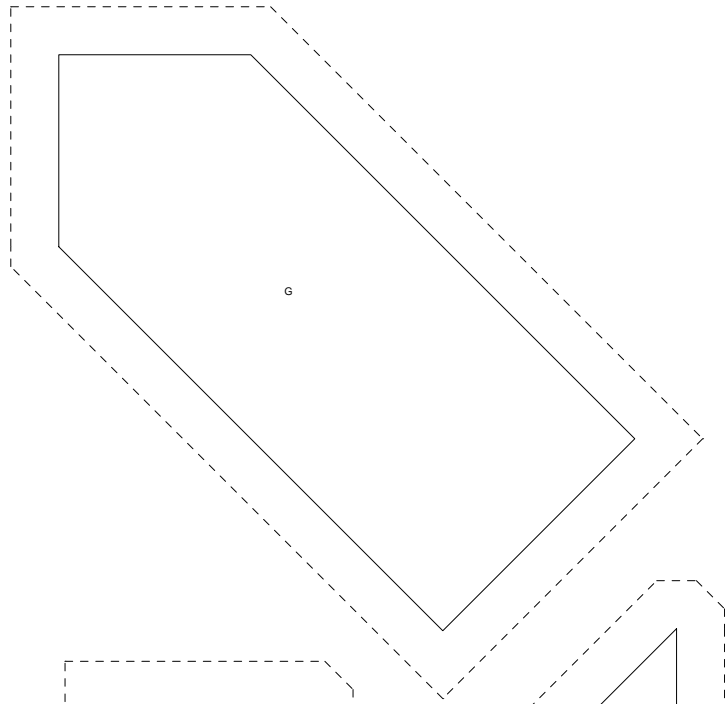
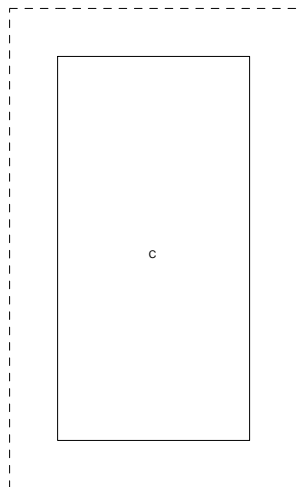
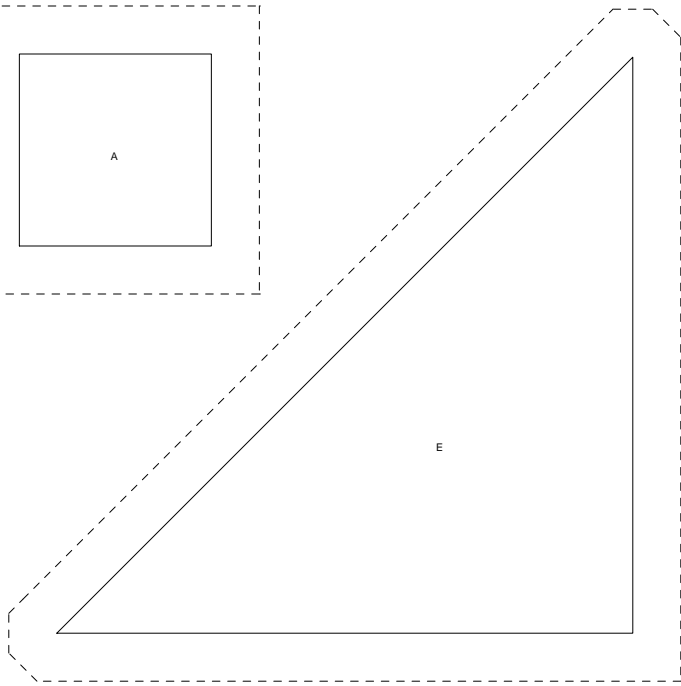
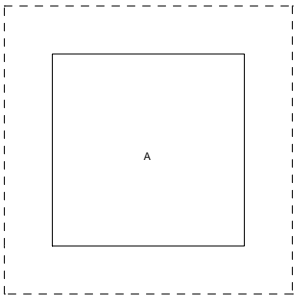
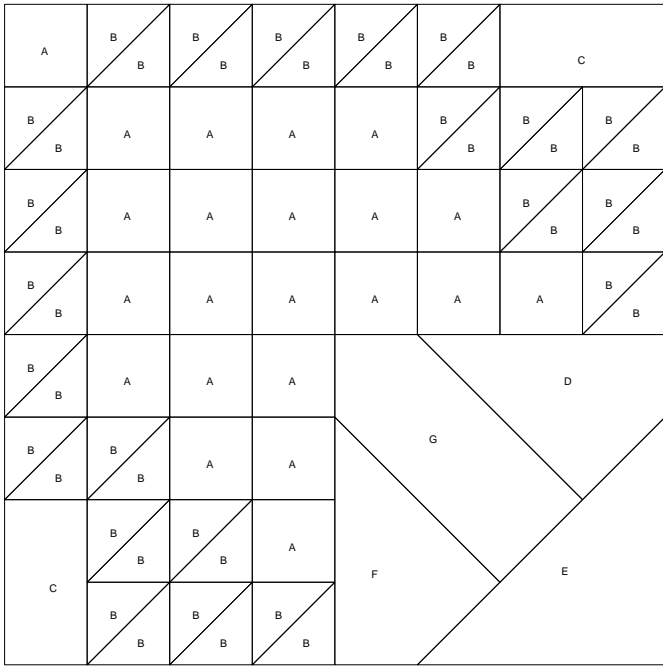

**Apple Tree**  
 Pattern for 8.00x8.00 block  
 Key Block (31/100 actual size)

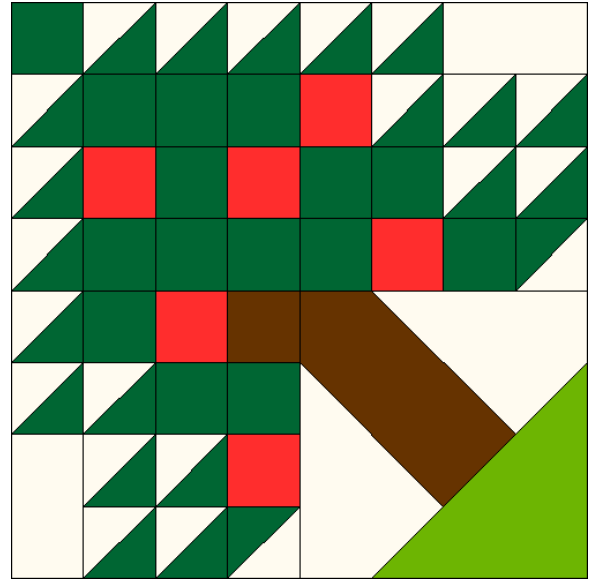
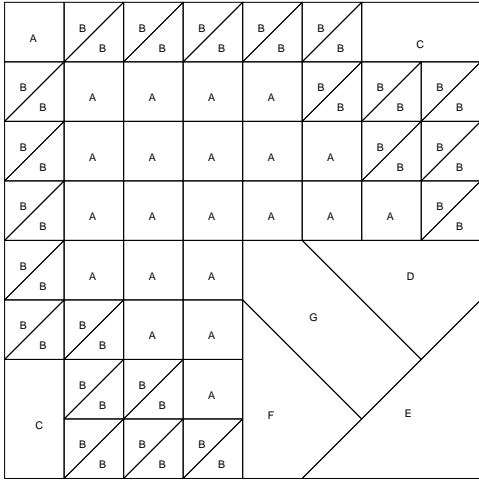

Cutting Diagrams

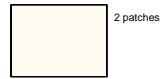
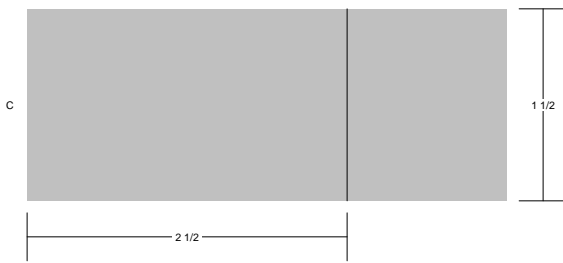
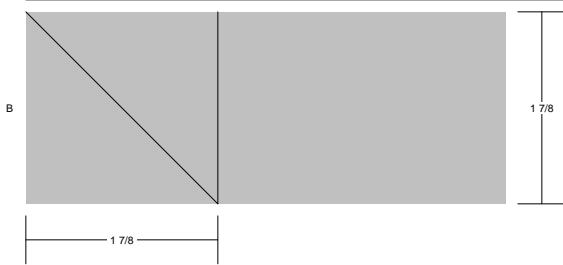
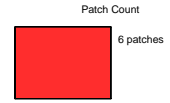
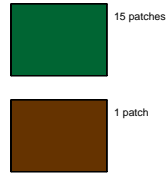

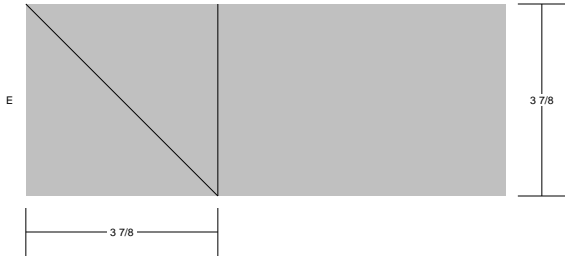

Basket Weave

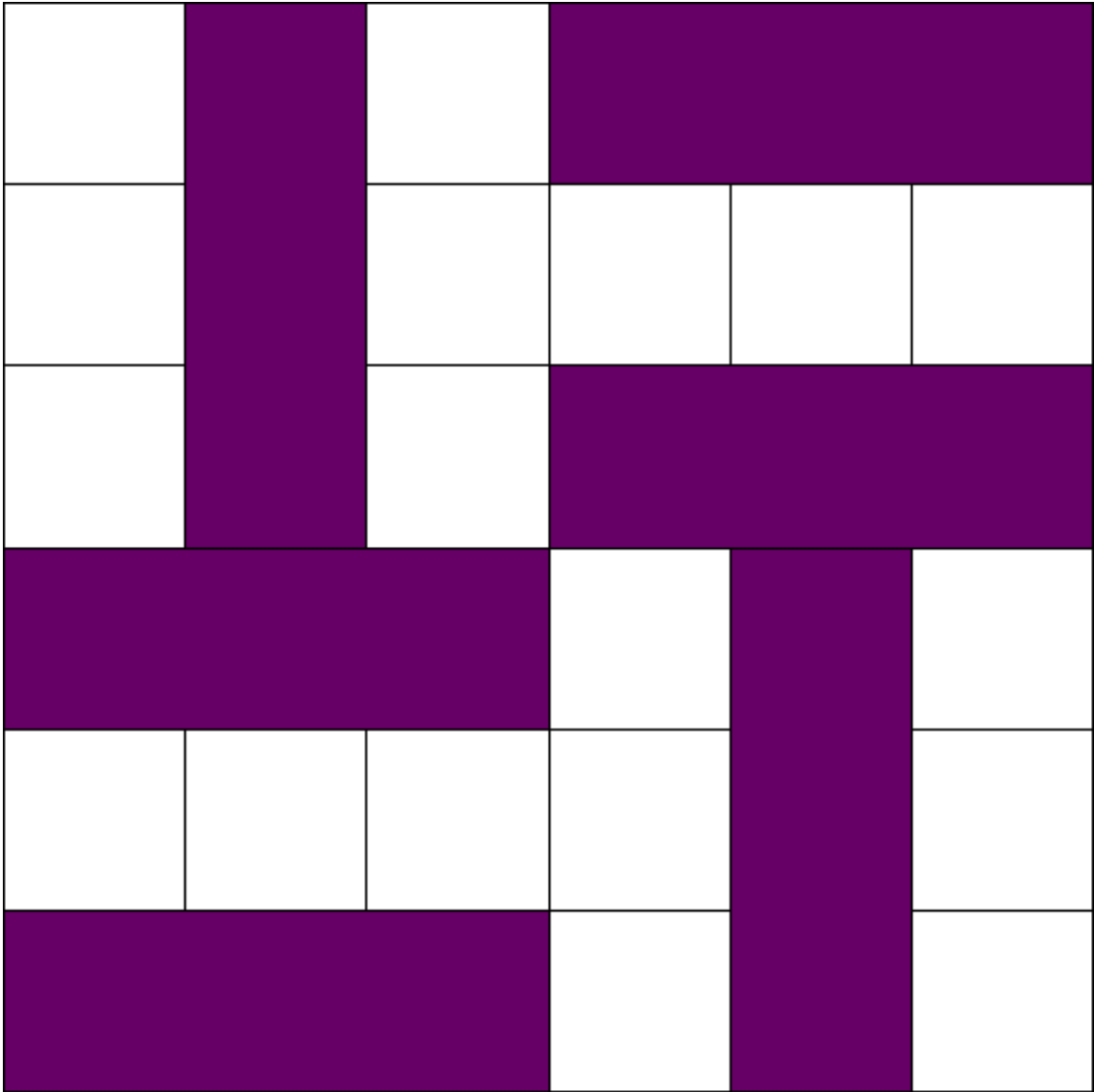

**Basket Weave**  
 Pattern for 12.00x12.00 block  
 Key Block (29/100 actual size)

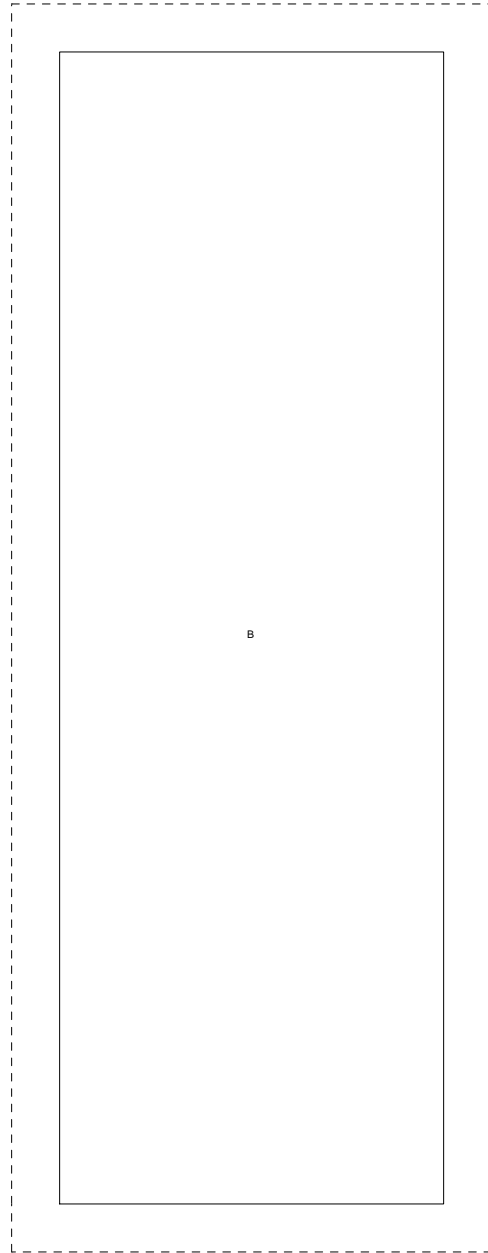
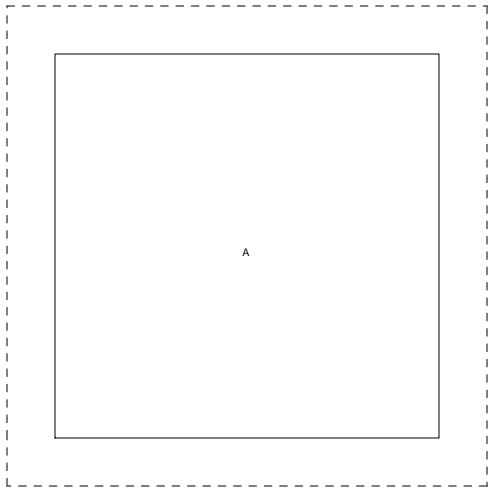
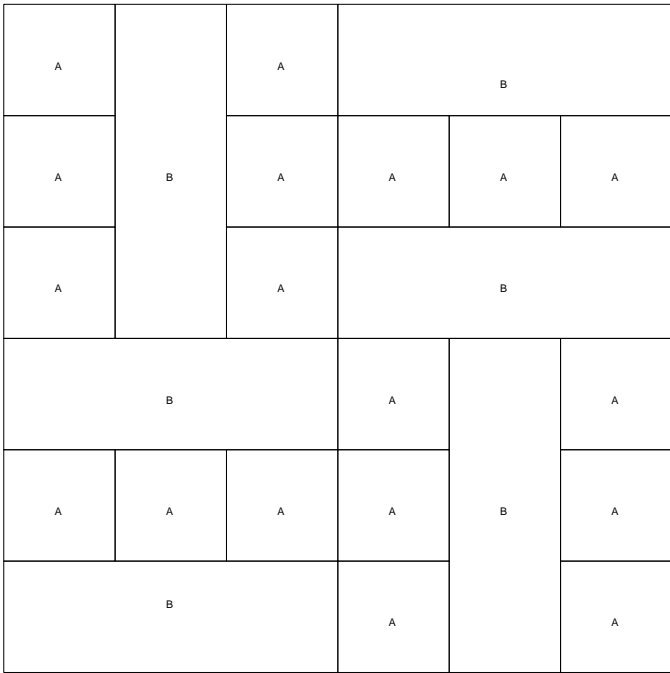

**Basket Weave**  
 Pattern for 12.00x12.00 block  
 Key Block (1/5 actual size)

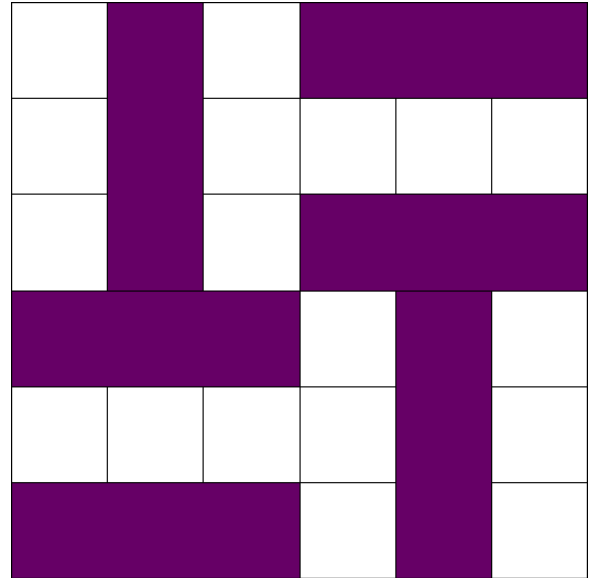
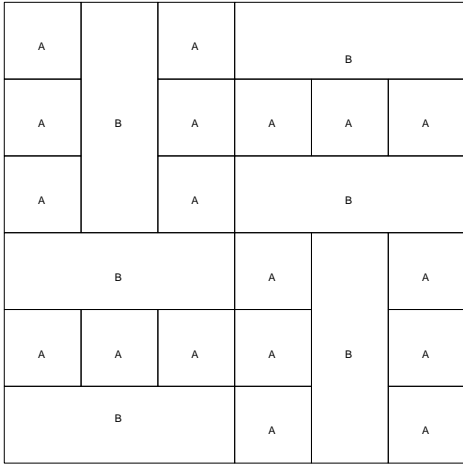

Cutting Diagrams



Patch Count

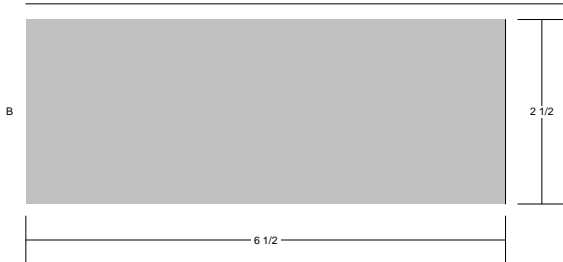

Chimneys & Cornerstones

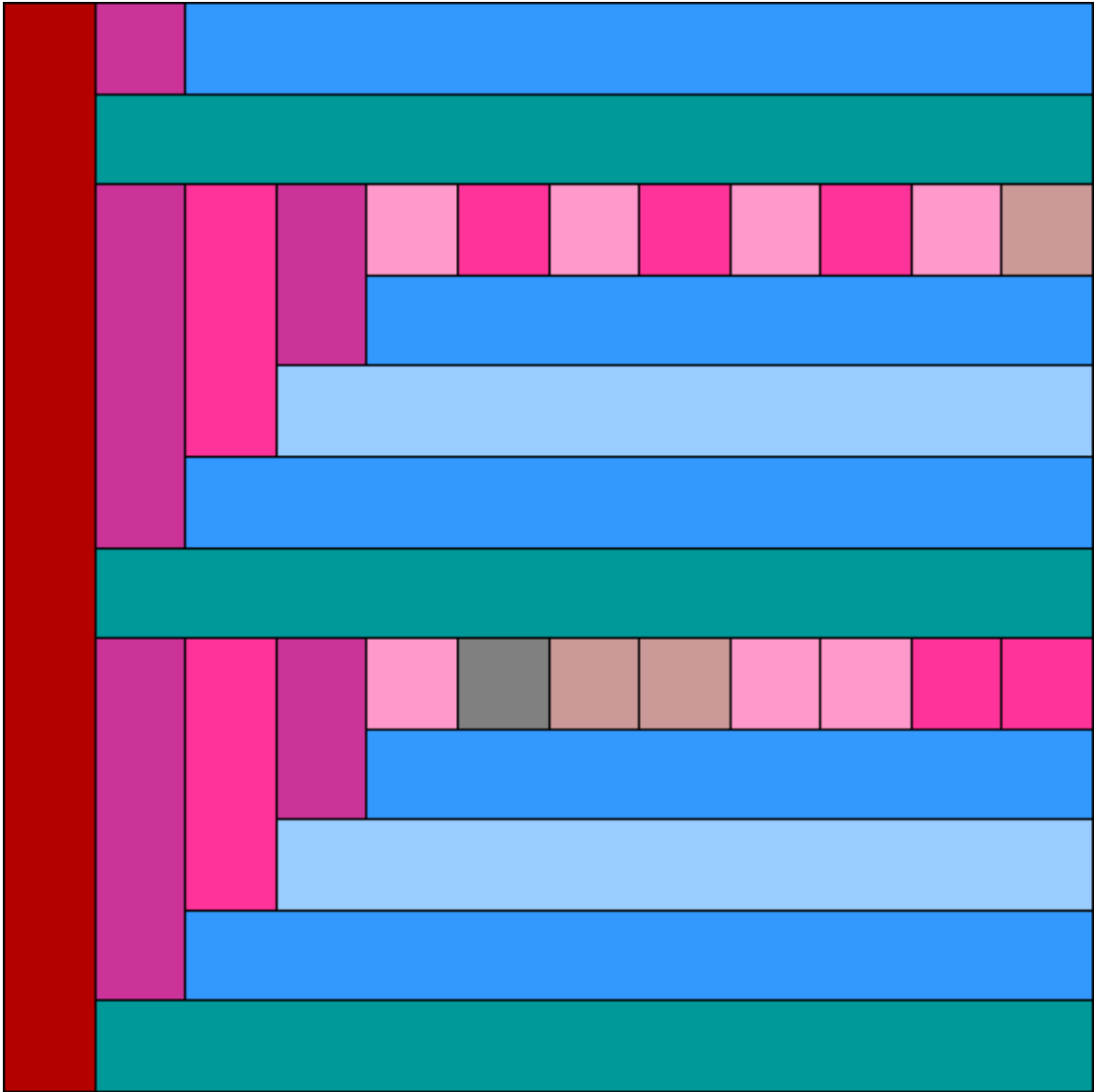

# Chimneys & Cornerstones

Pattern for 12.00x12.00 block  
Key Block (29/100 actual size)

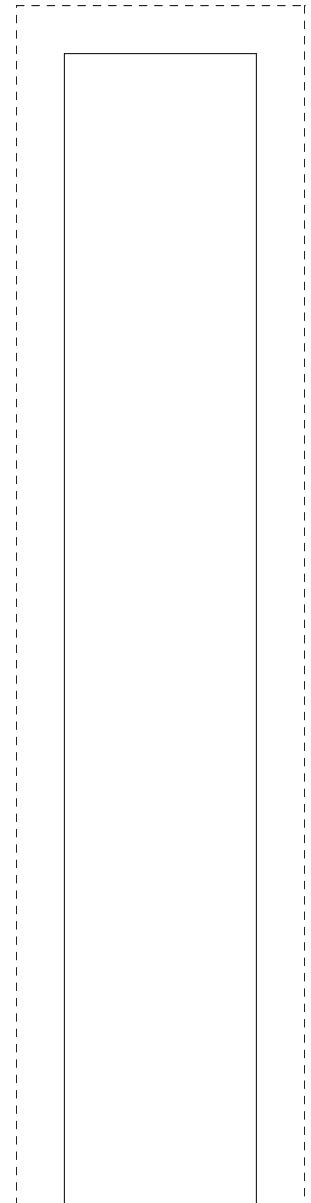
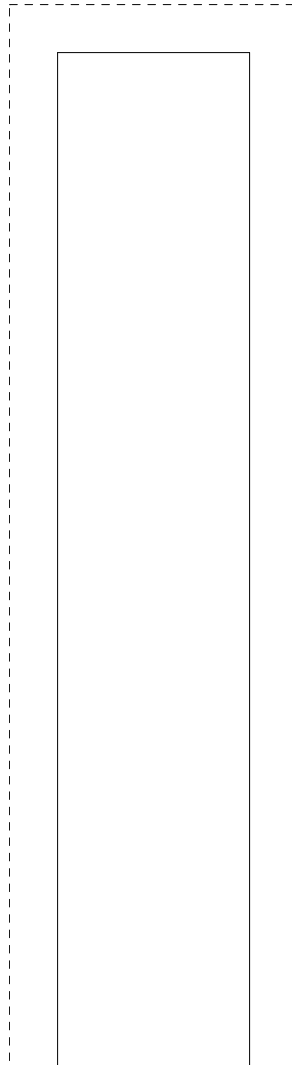
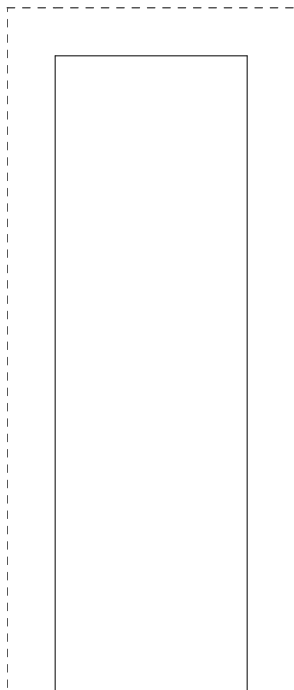
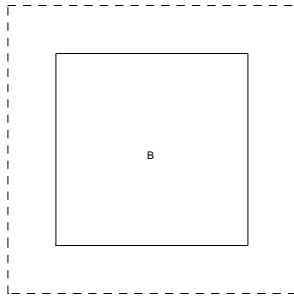
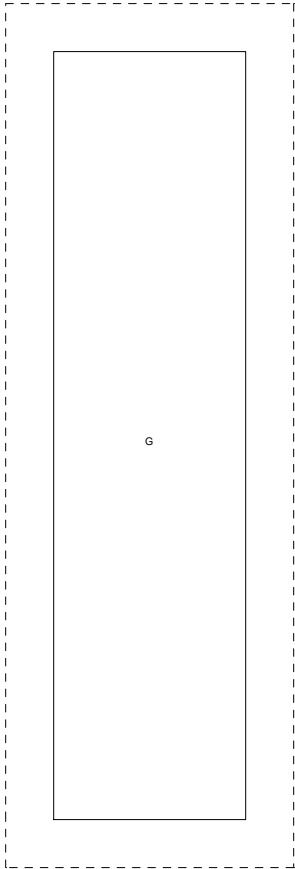
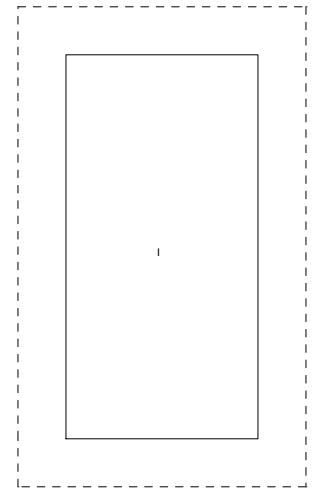
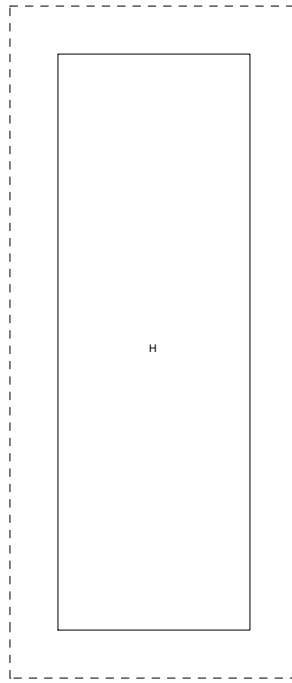
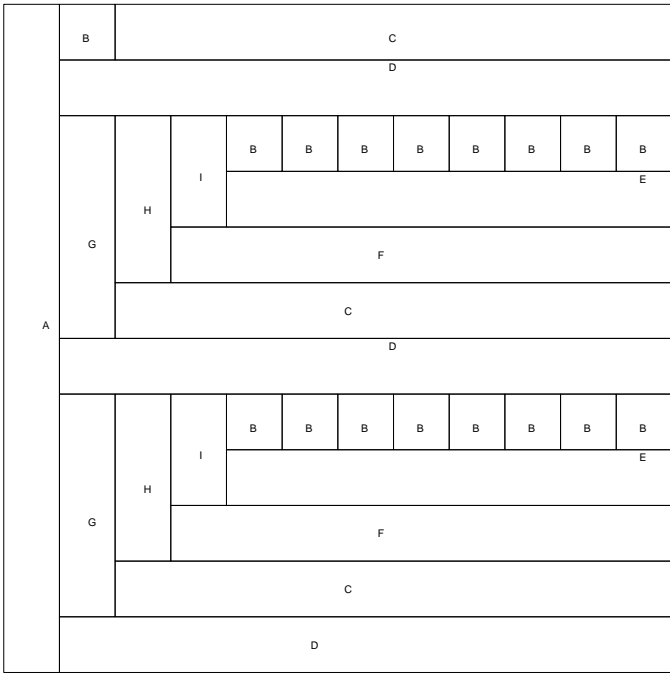



E

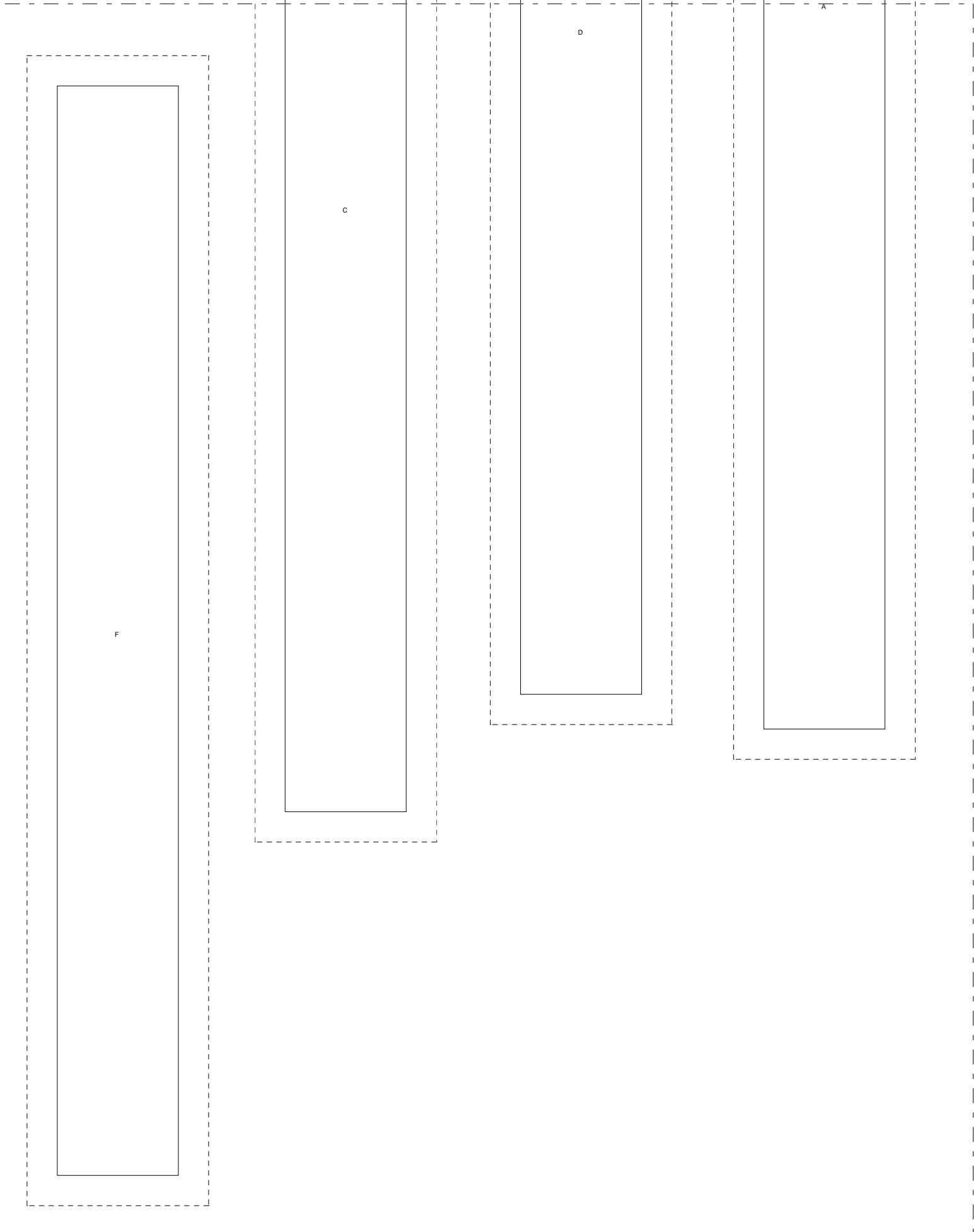

# Chimneys & Cornerstones

Pattern for 12.00x12.00 block  
Key Block (1/5 actual size)

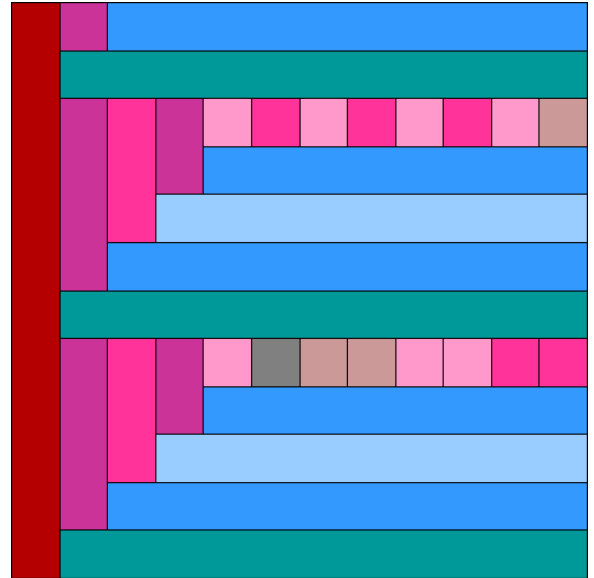
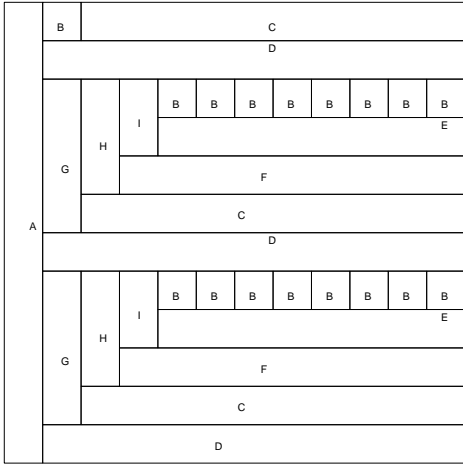

Cutting Diagrams

Patch Count

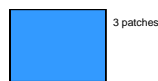
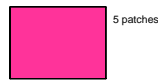
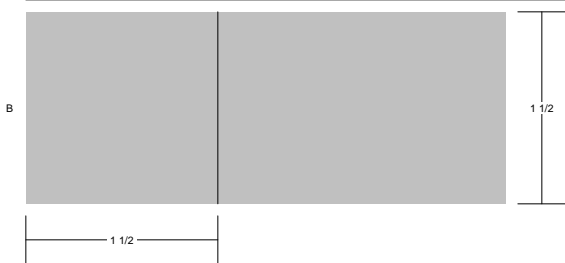
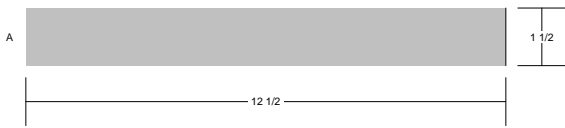

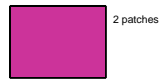
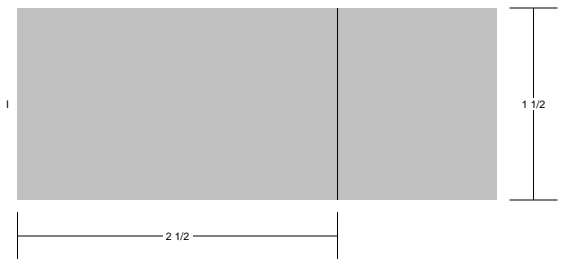
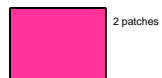
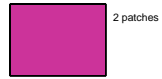
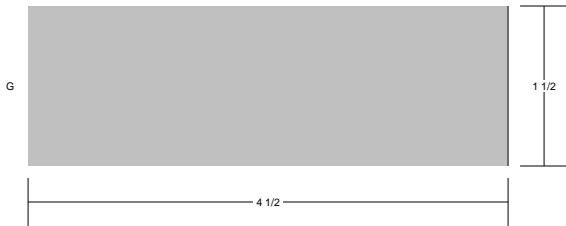
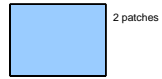
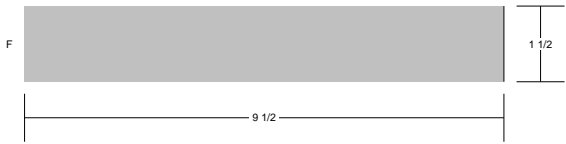
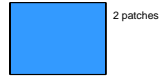
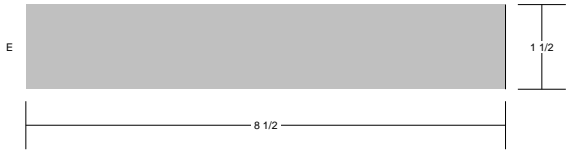
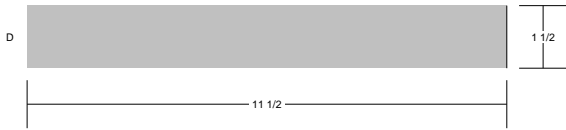

Four Leaf Clover

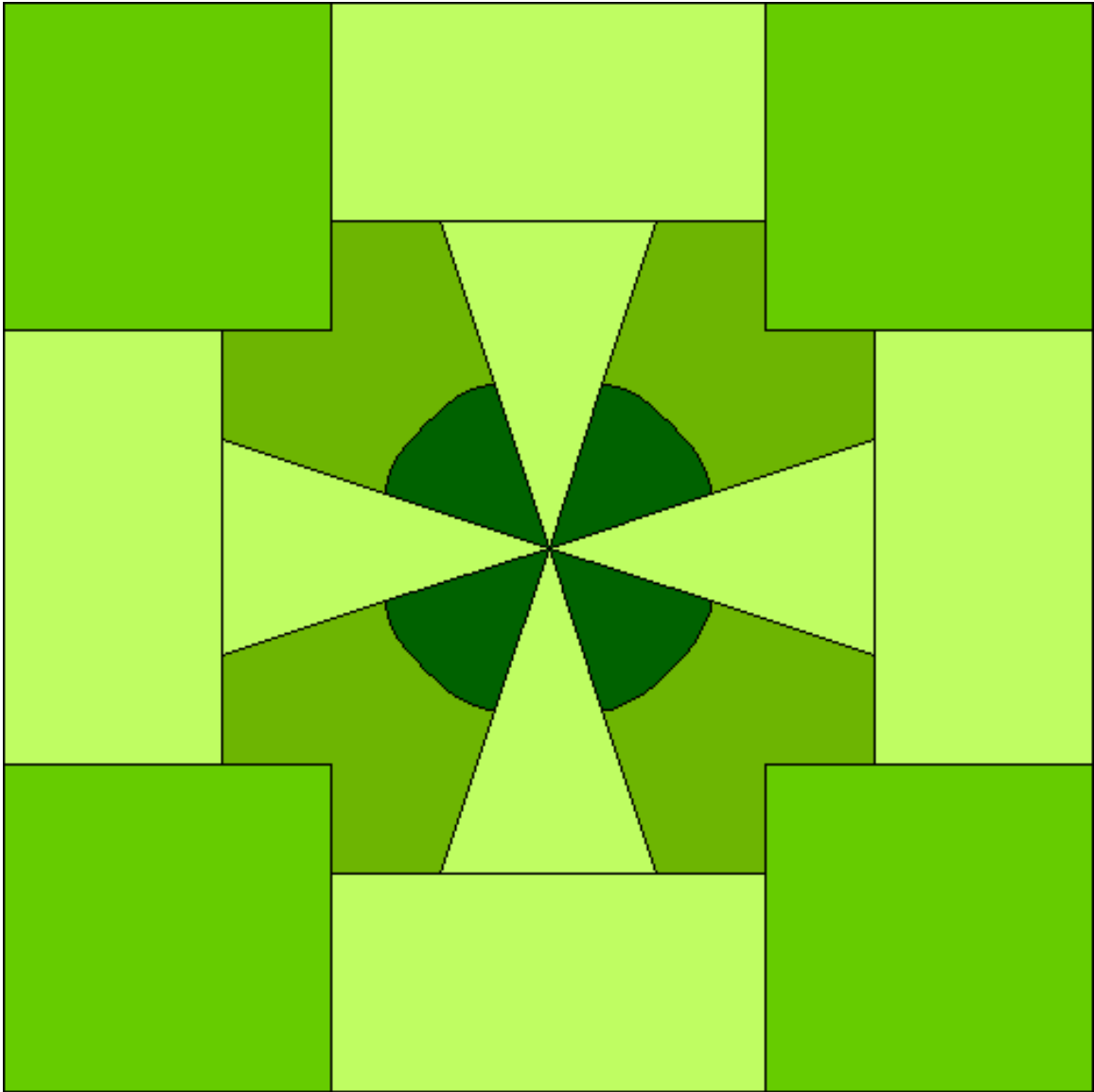

Four Leaf Clover  
Pattern for 10.00x10.00 block  
Key Block (17/50 actual size)

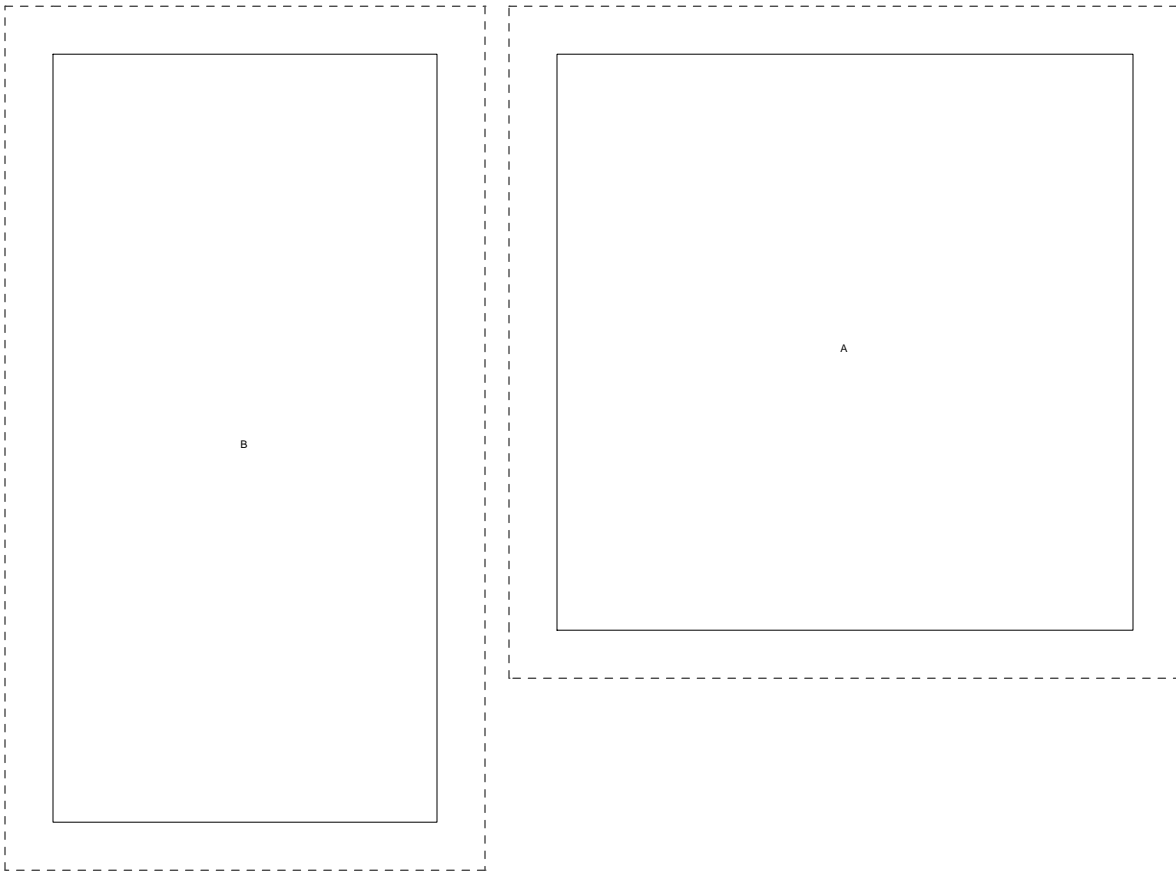
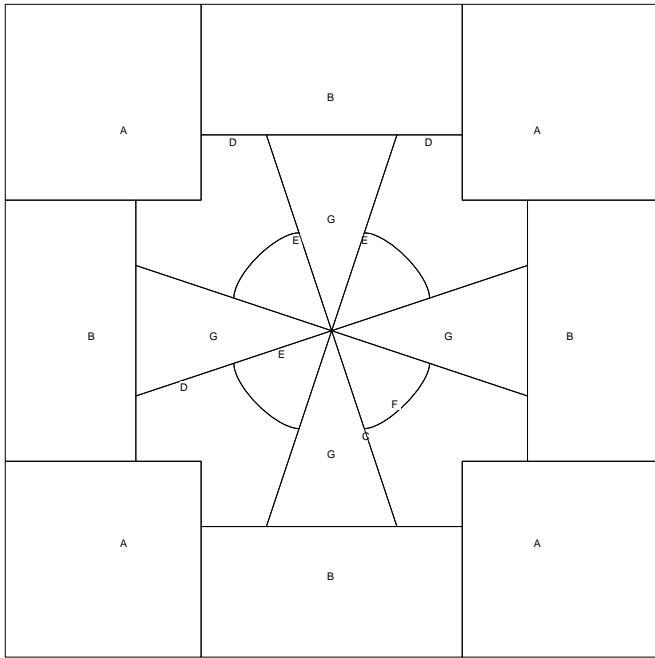

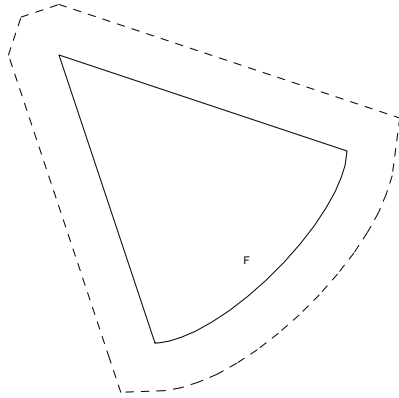
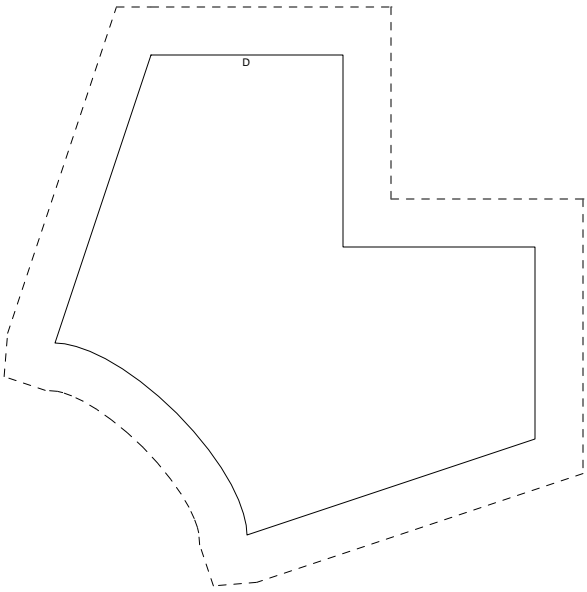
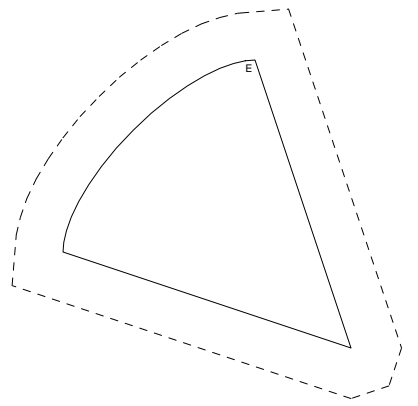
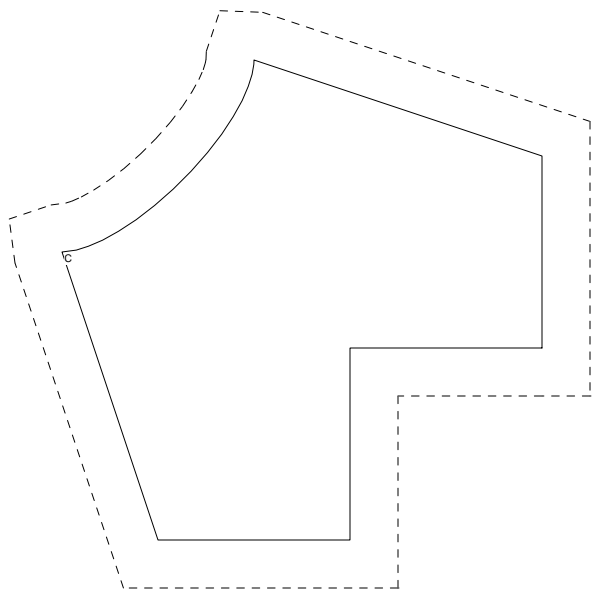
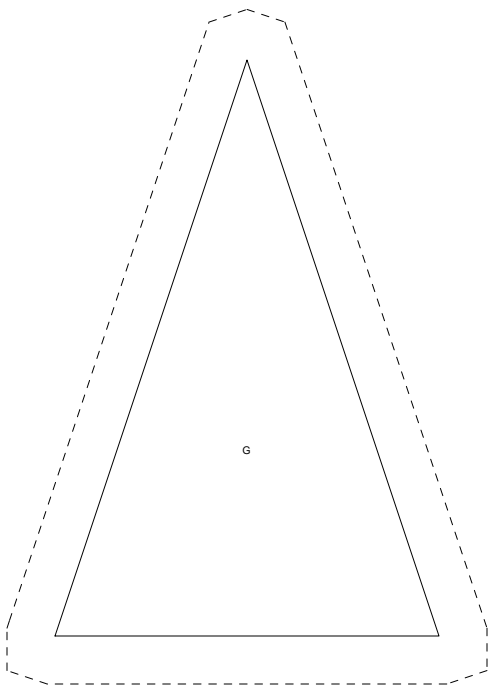

**Four Leaf Clover**  
 Pattern for 10.00x10.00 block  
 Key Block (5/20 actual size)

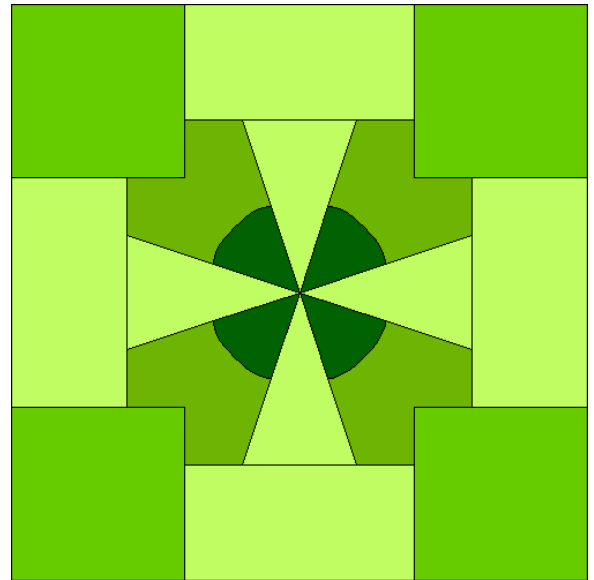
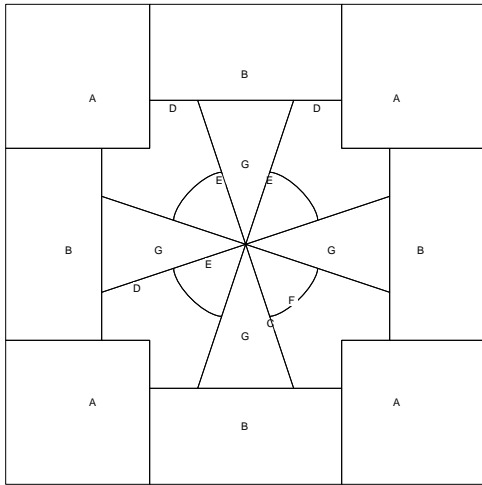

**Cutting Diagrams**

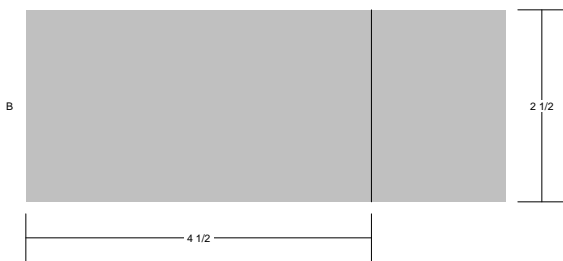
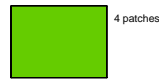

Goose Creek

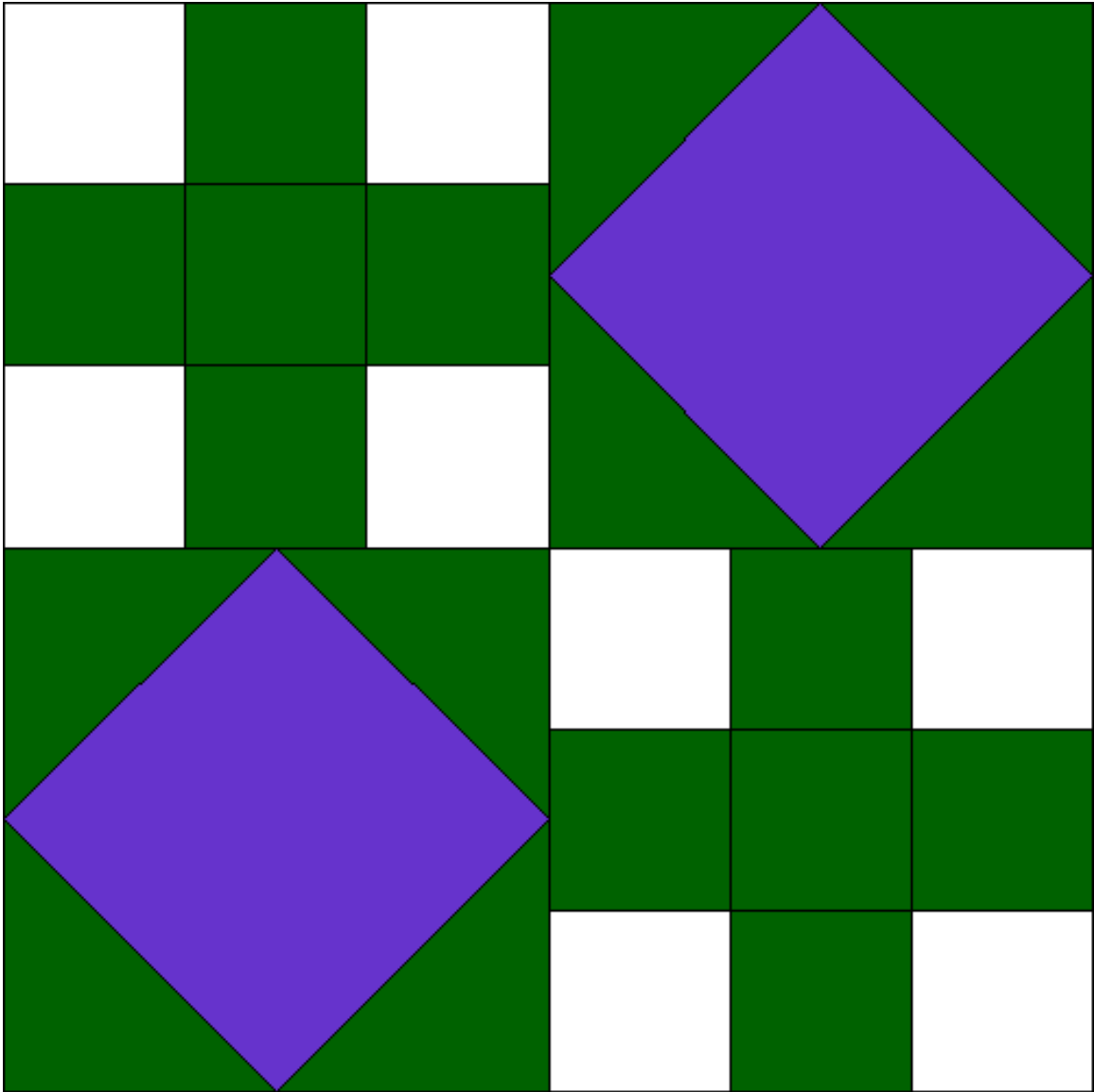

Goose Creek  
Pattern for 12.00x12.00 block  
Key Block (29/100 actual size)

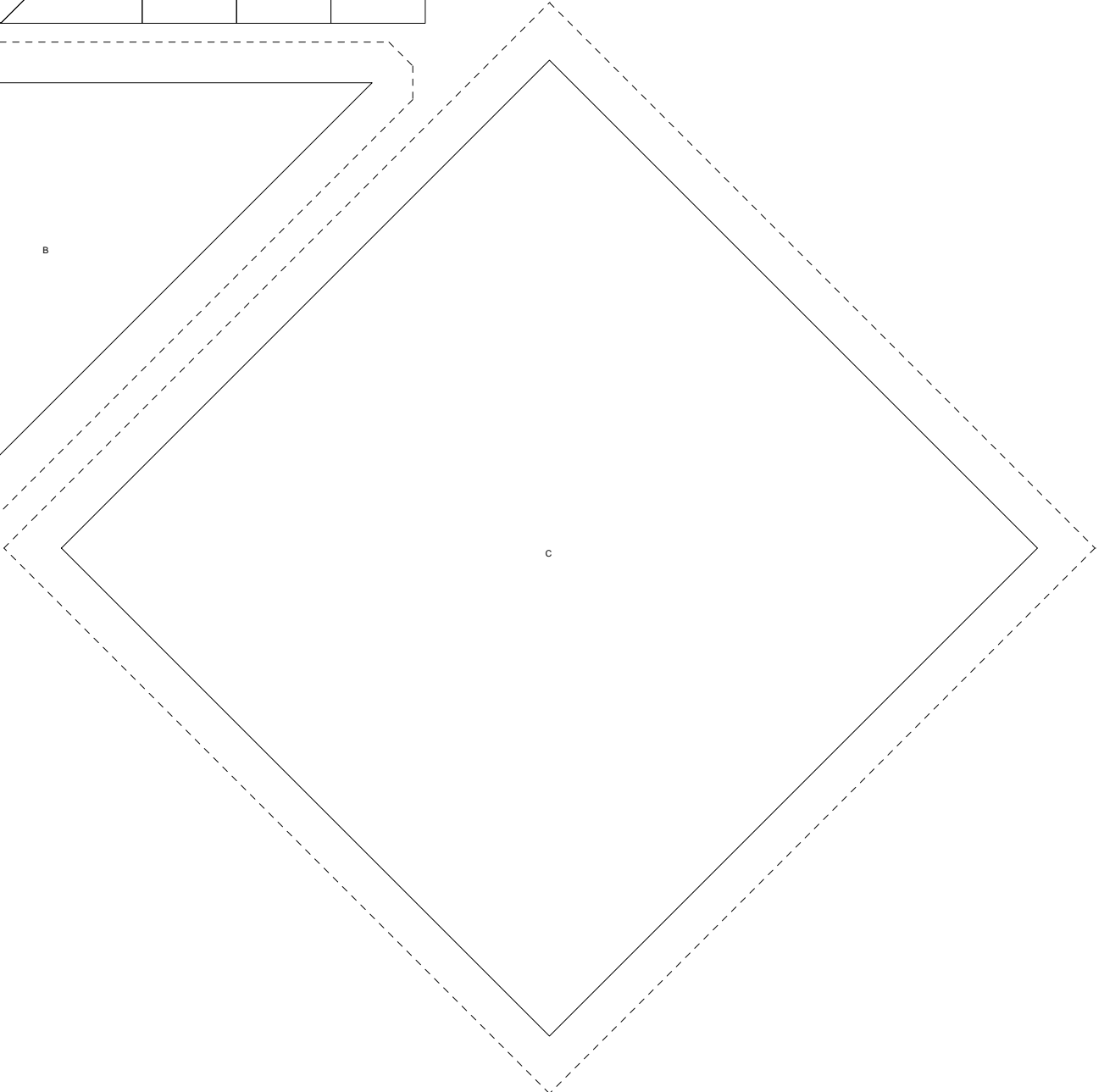
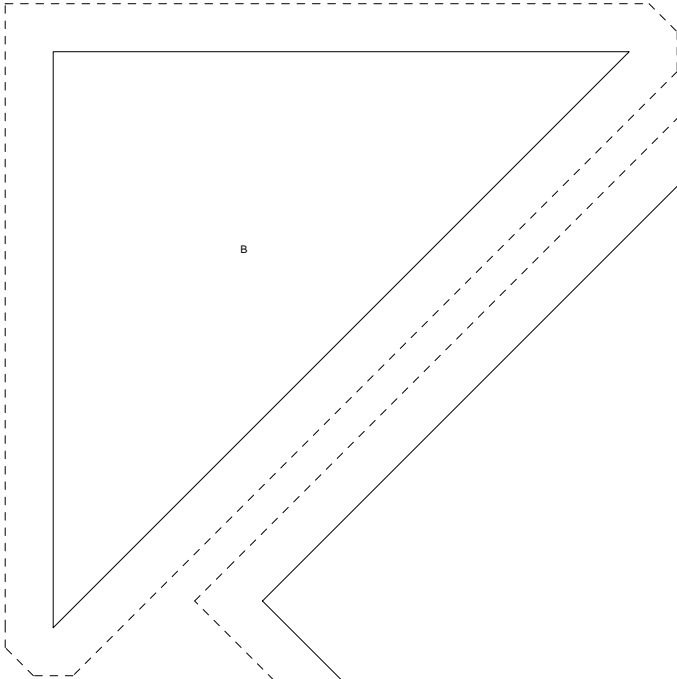
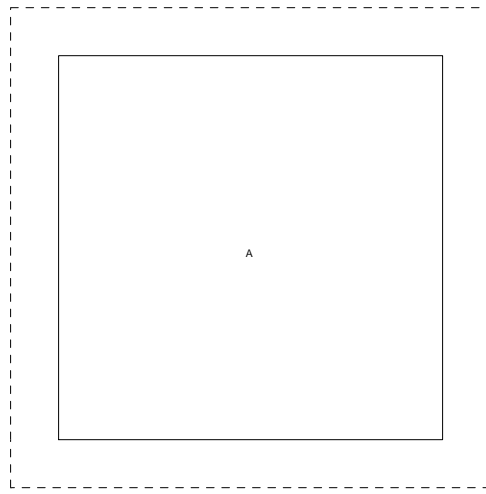
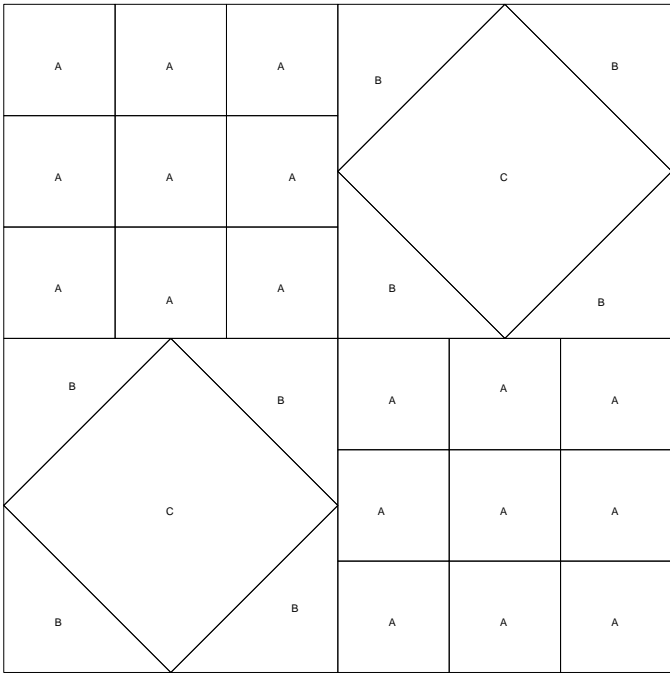

**Goose Creek**  
 Pattern for 12.00x12.00 block  
 Key Block (1/5 actual size)

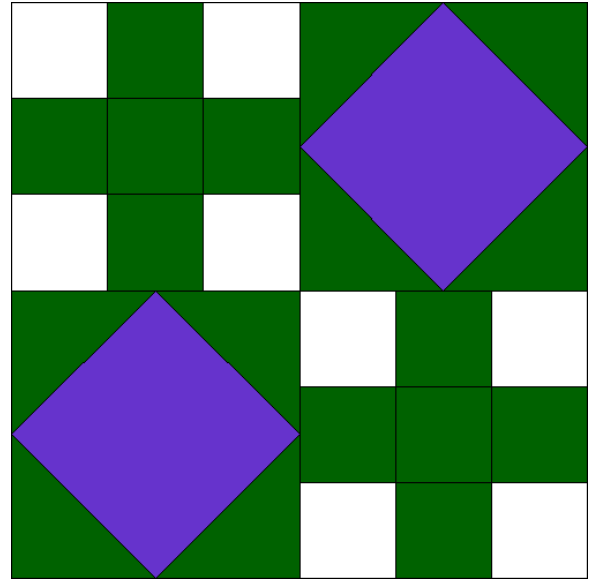
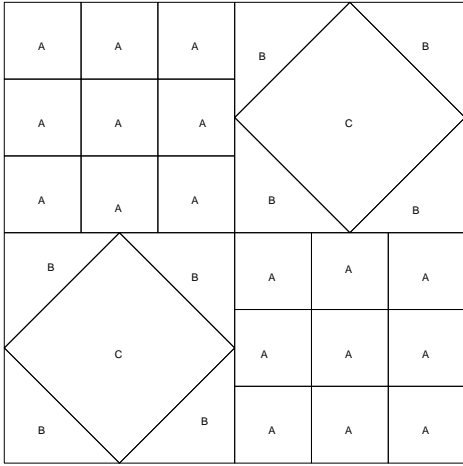

**Cutting Diagrams**

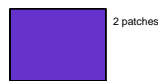
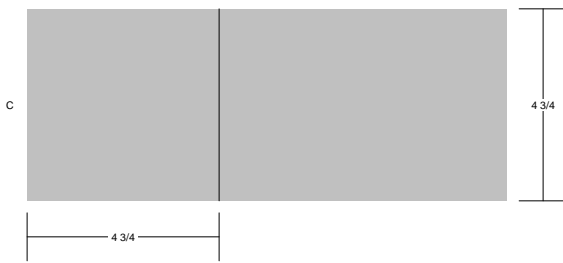
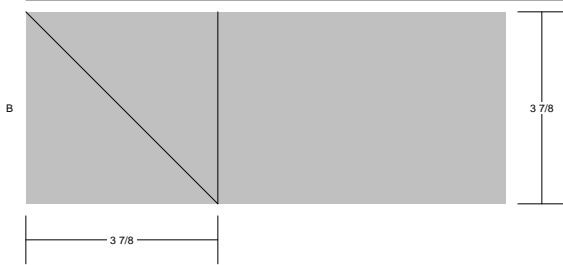
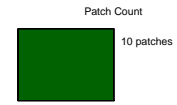

Migration

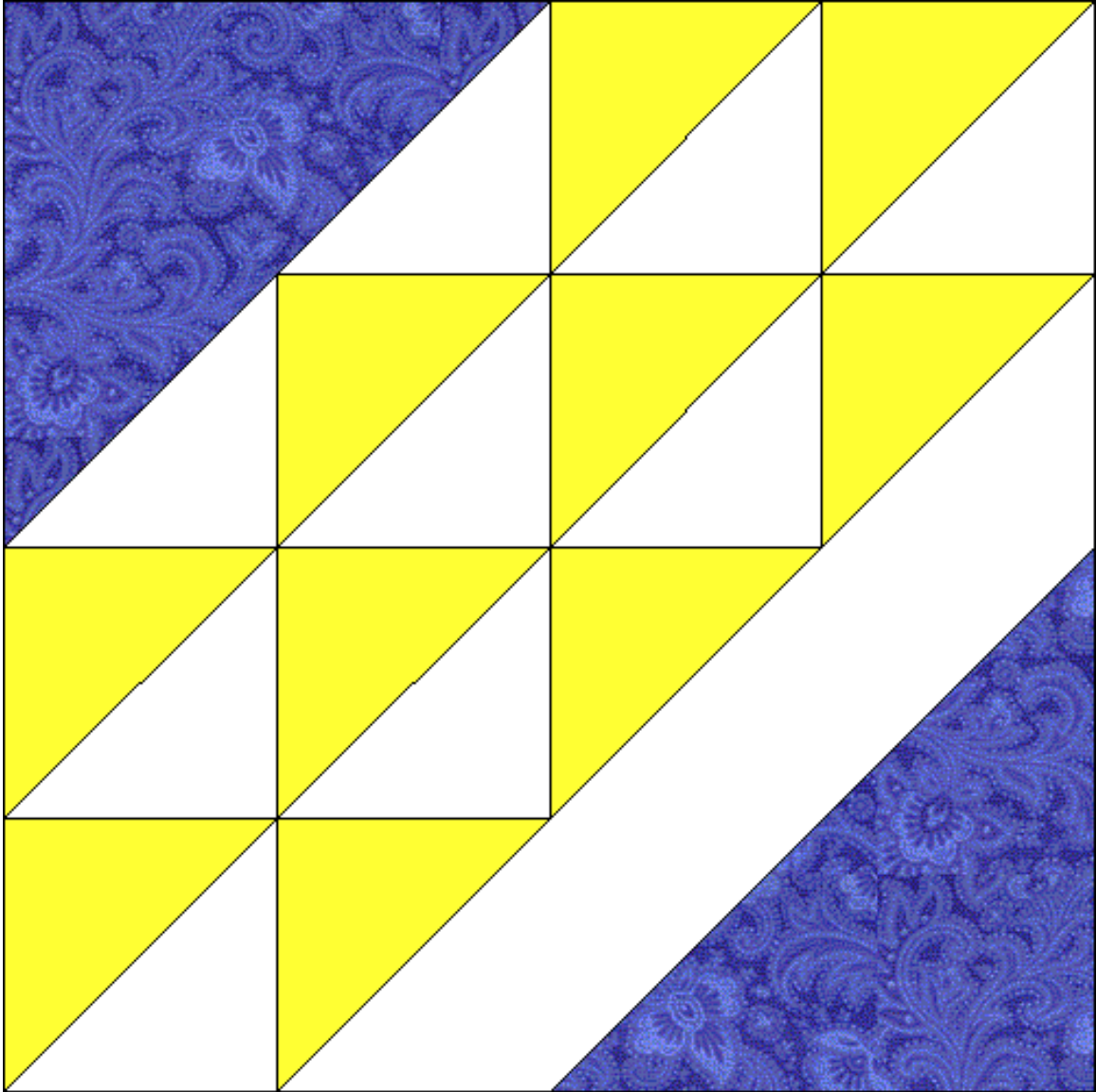

Migration  
Pattern for 8.00x8.00 block  
Key Block (43/100 actual size)

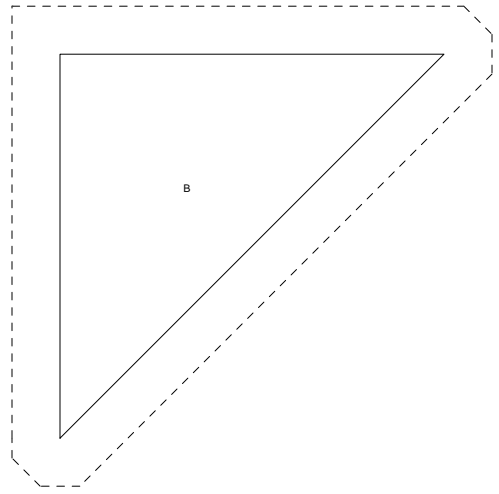
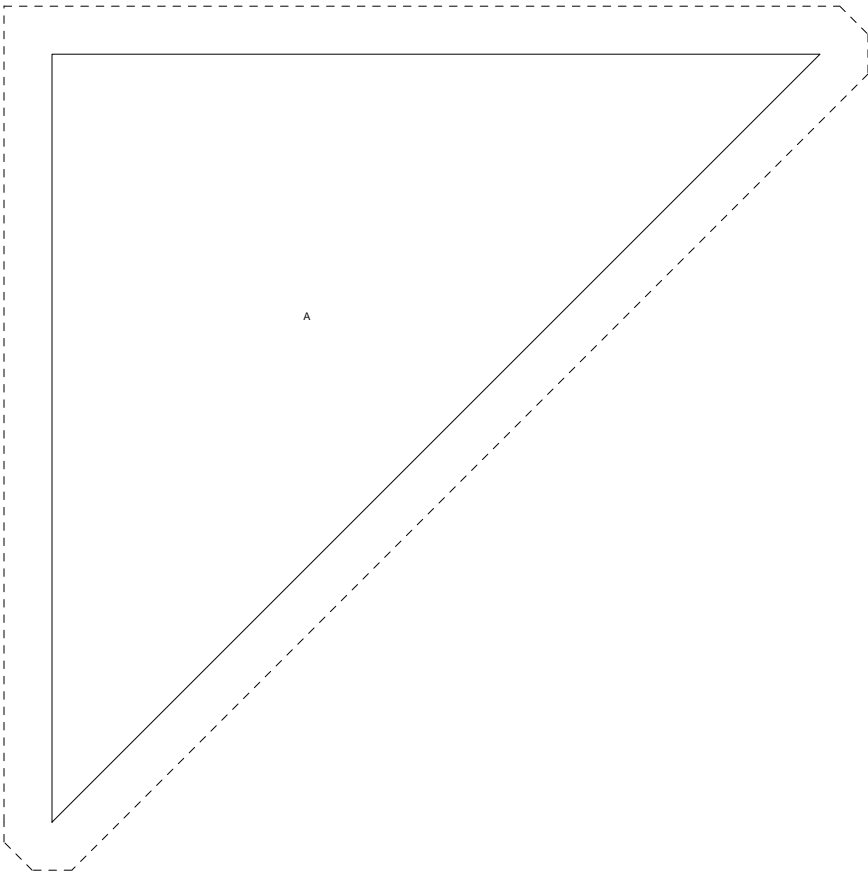
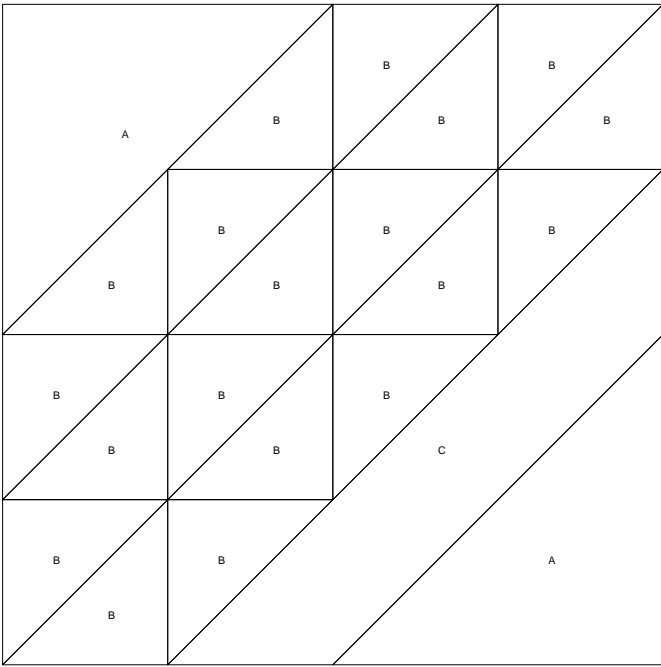

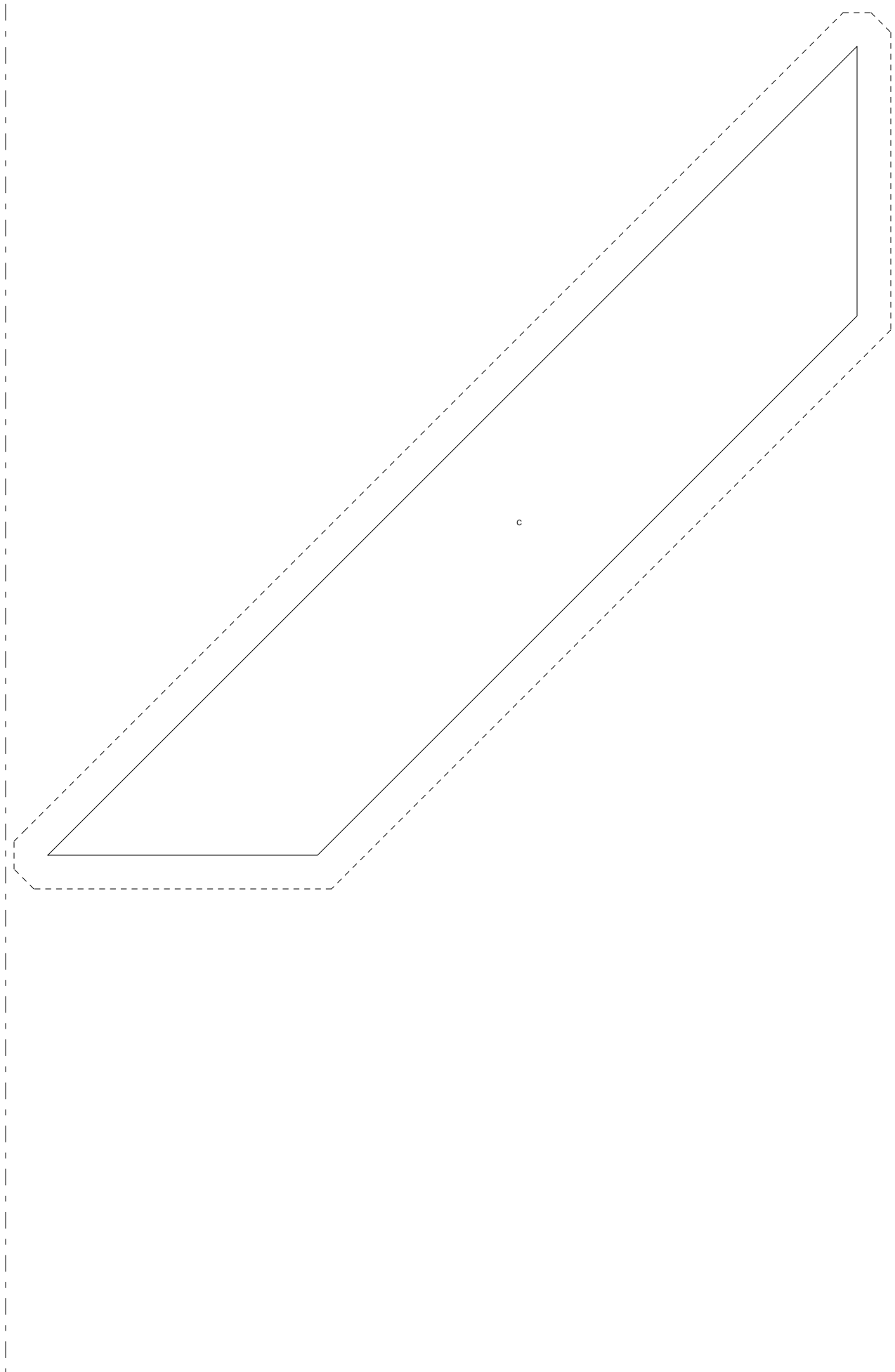

**Migration**  
 Pattern for 8.00x8.00 block  
 Key Block (31/100 actual size)

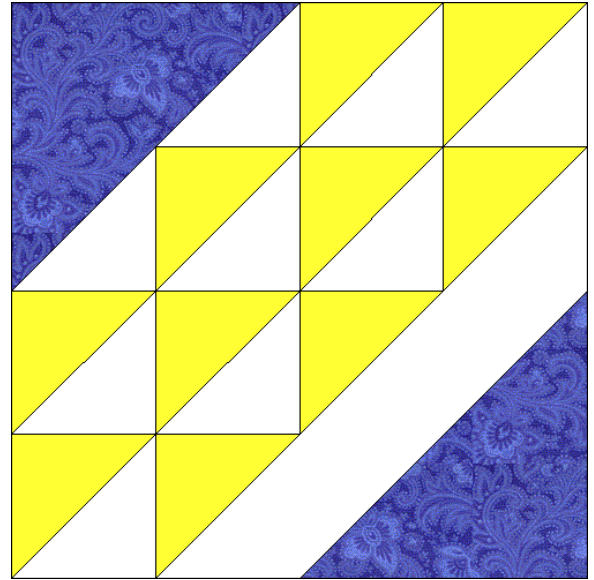
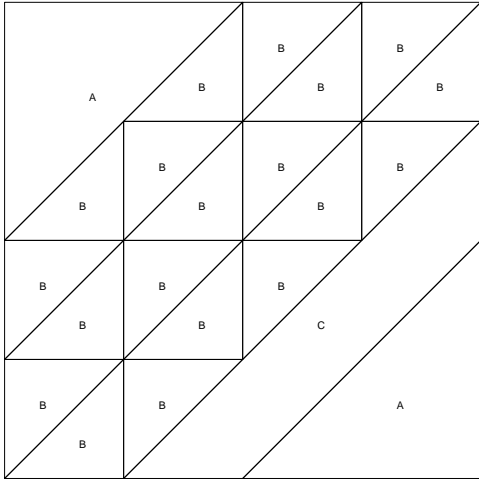

**Cutting Diagrams**

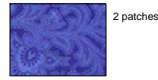
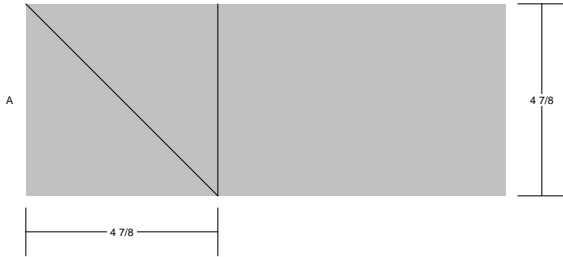

**Patch Count**

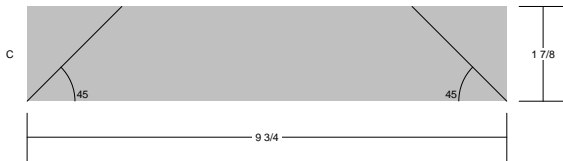
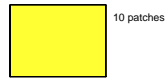
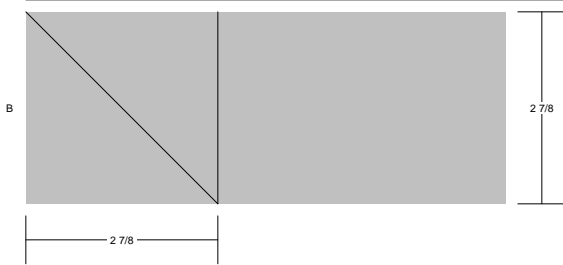

Multiple Square

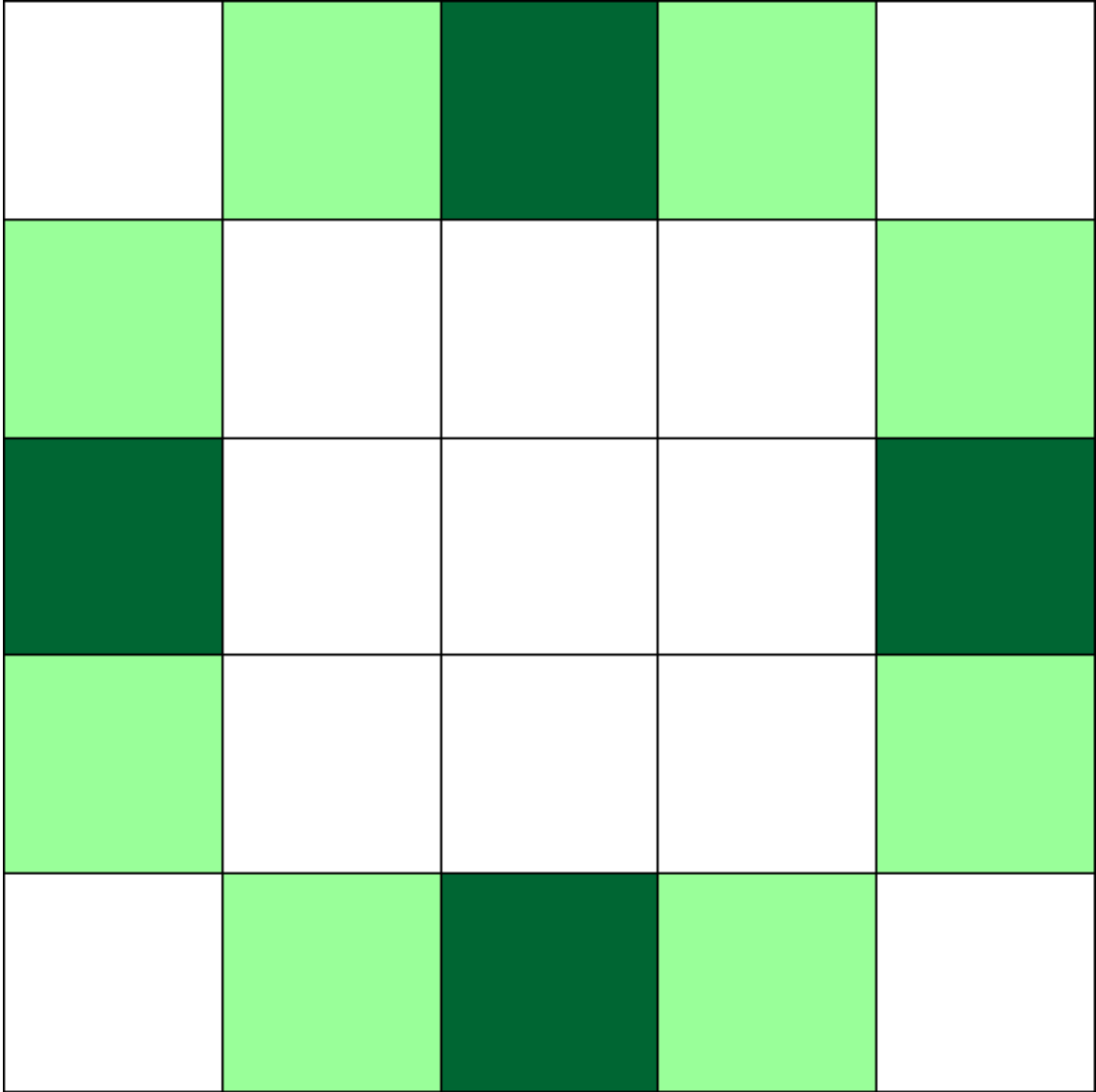

**Multiple Square**  
Pattern for 10.00x10.00 block  
Key Block (17/50 actual size)

A	A	A	A	A
A	A	A	A	A
A	A	A	A	A
A	A	A	A	A
A	A	A	A	A

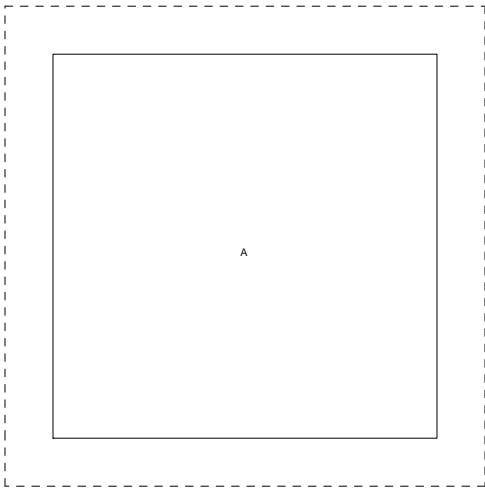

**Multiple Square**  
 Pattern for 10.00x10.00 block  
 Key Block (5/20 actual size)

A	A	A	A	A
A	A	A	A	A
A	A	A	A	A
A	A	A	A	A
A	A	A	A	A

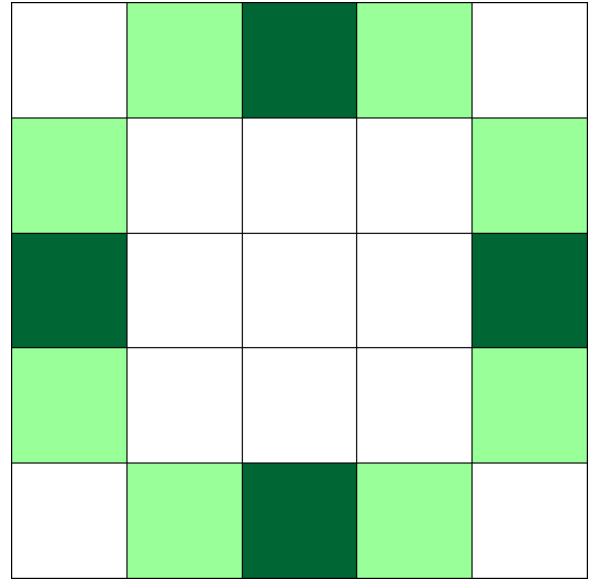

**Cutting Diagrams**



**Patch Count**

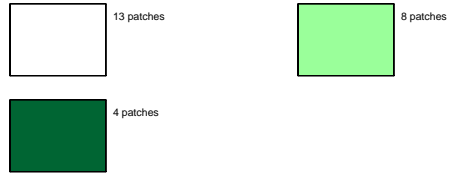

Nine Patch Plaid

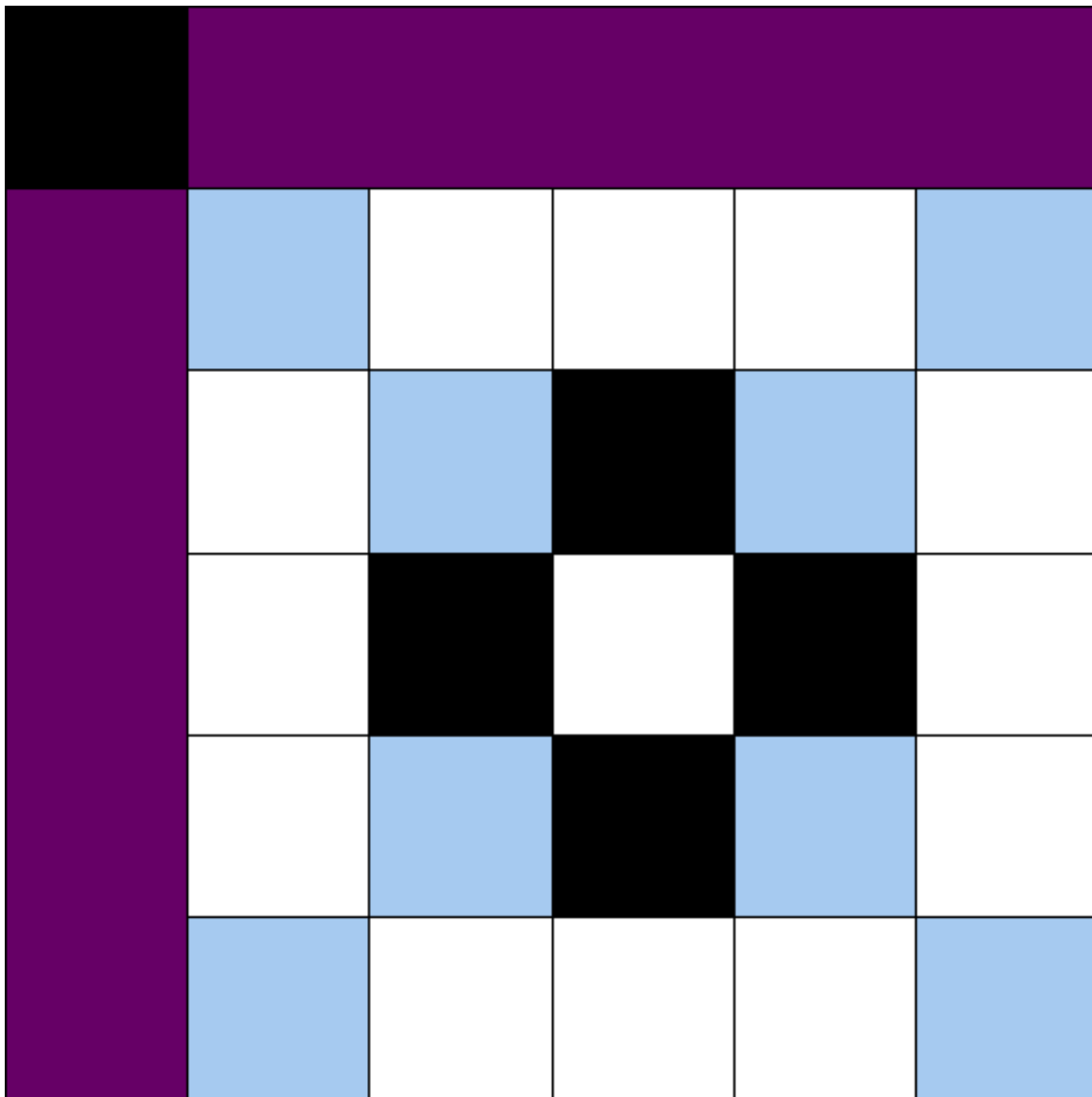

Nine Patch Plaid  
Pattern for 12.00x12.00 block  
Key Block (29/100 actual size)

A	B				
B	A	A	A	A	A
	A	A	A	A	A
	A	A	A	A	A
	A	A	A	A	A
	A	A	A	A	A

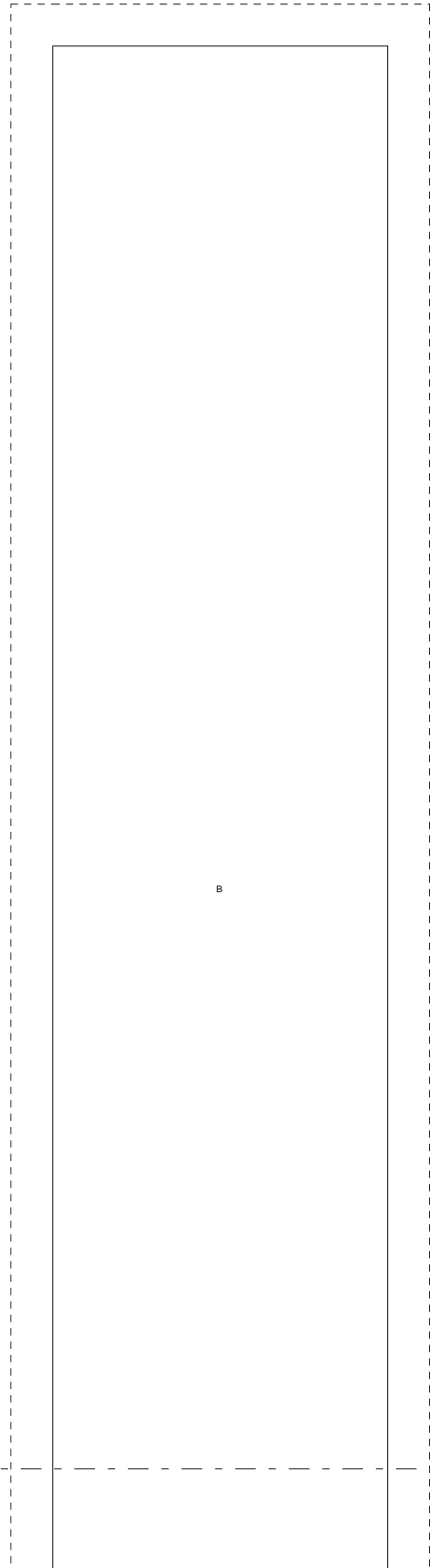
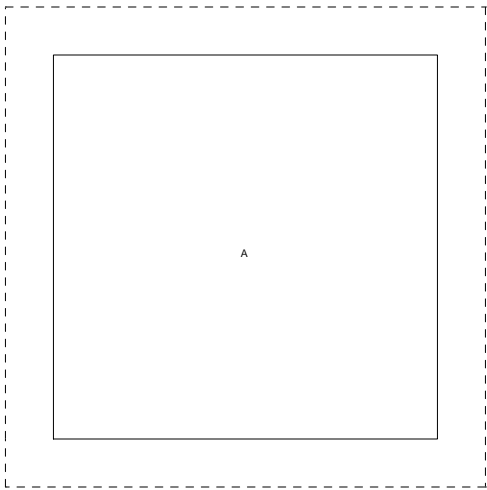

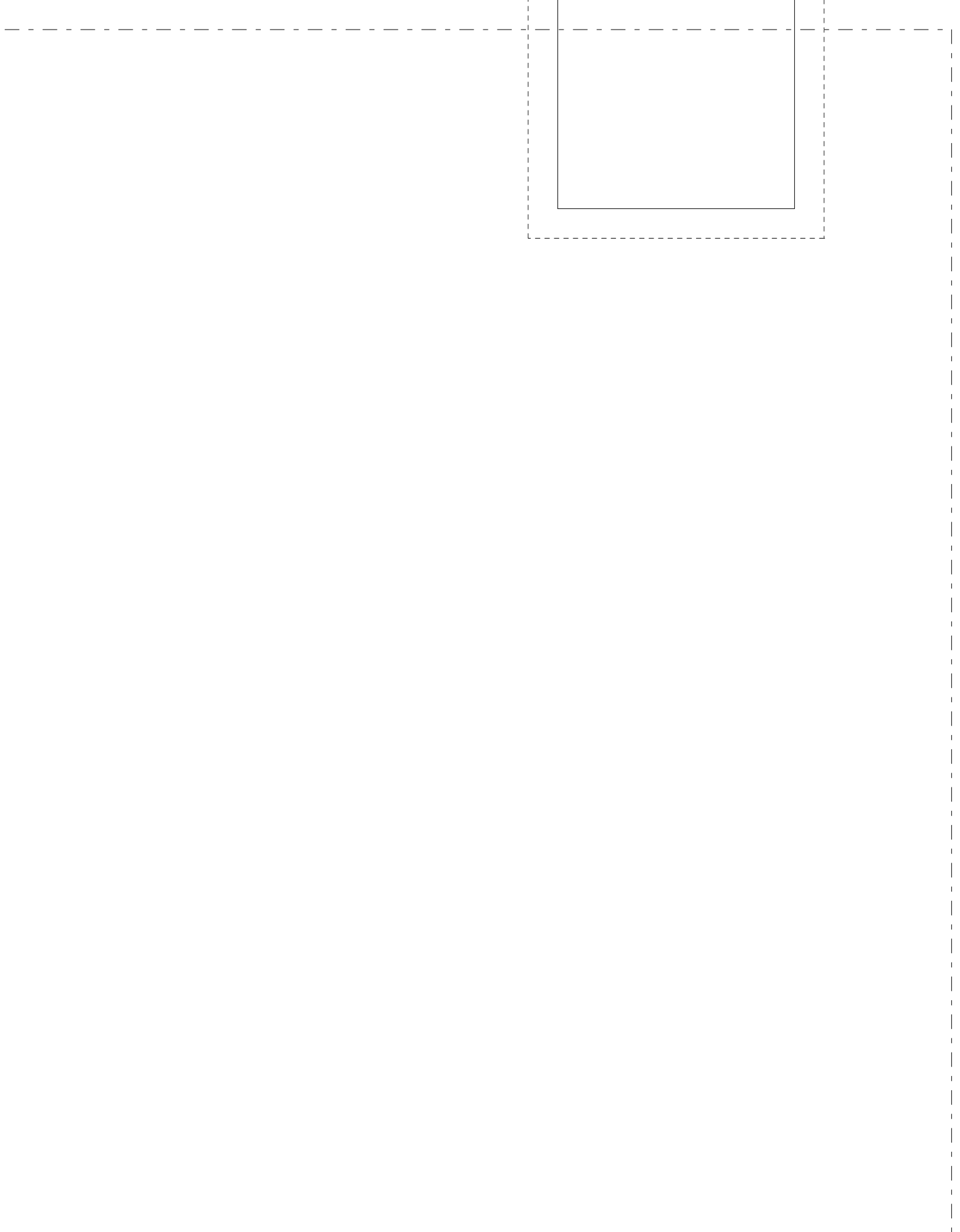

**Nine Patch Plaid**  
 Pattern for 12.00x12.00 block  
 Key Block (1/5 actual size)

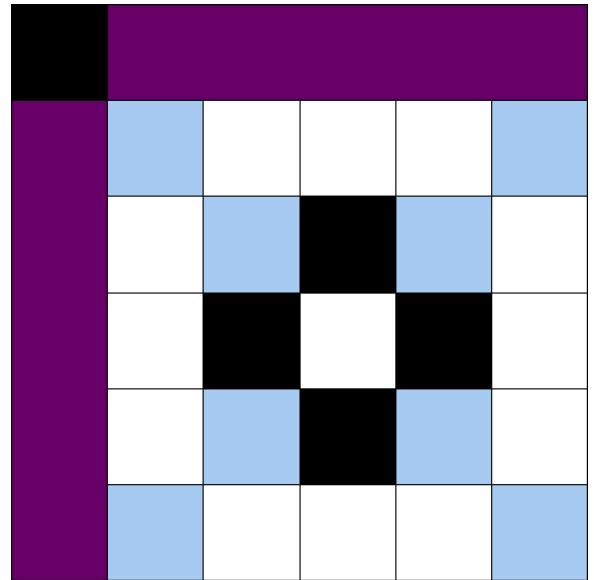
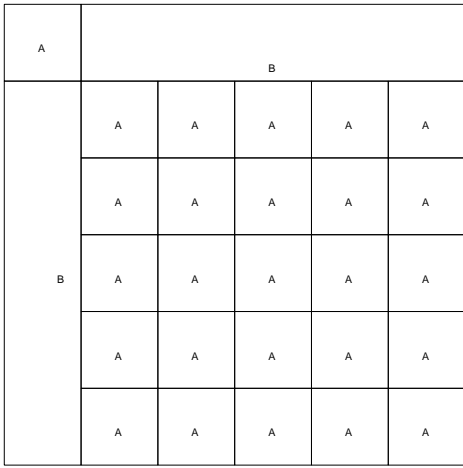

**Cutting Diagrams**

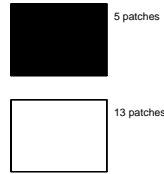

**Patch Count**

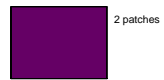
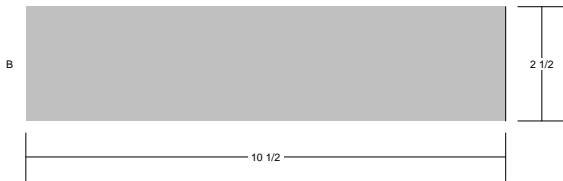

# Pieced Tulips Block!%\$]bW `V`cW

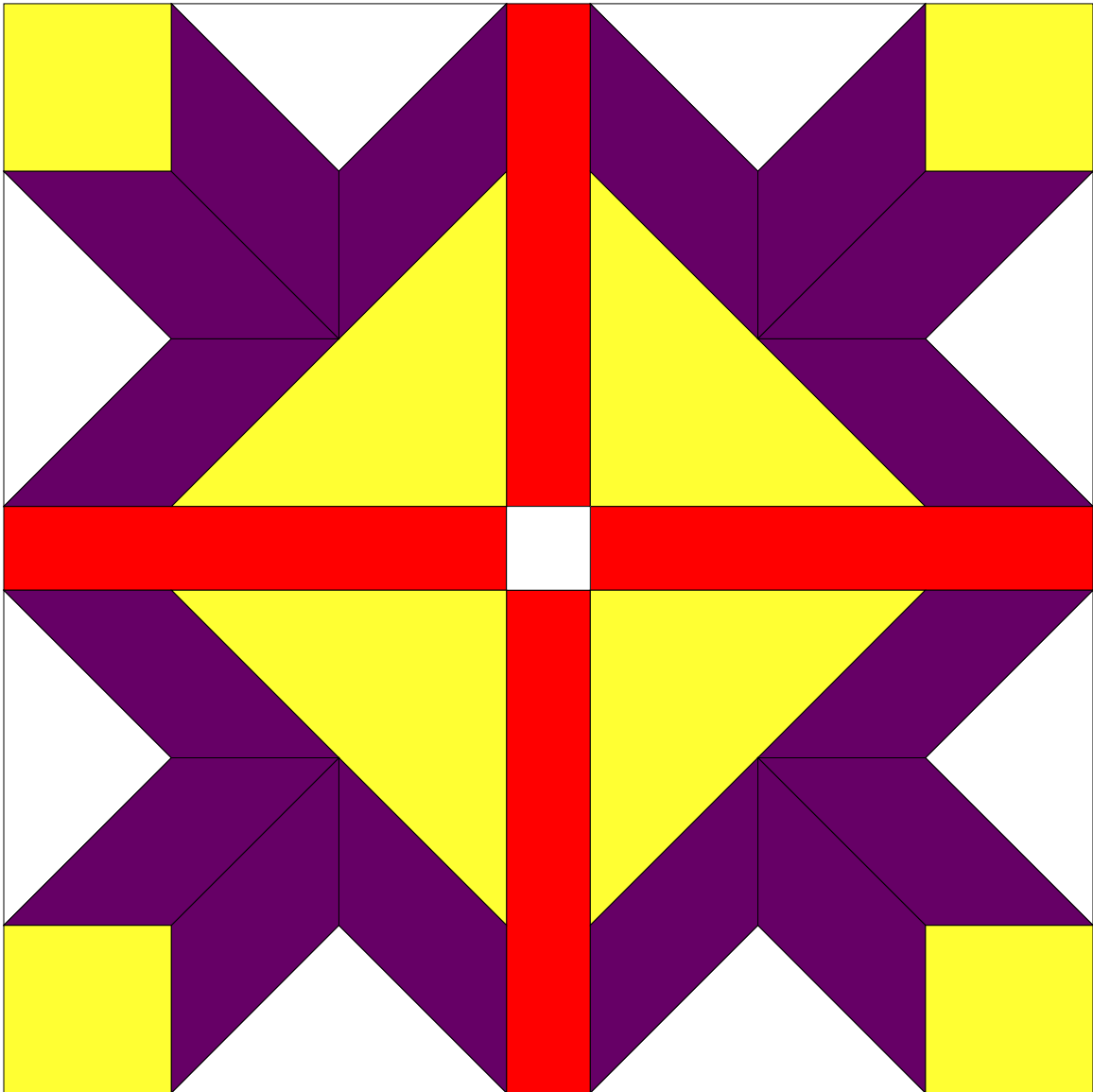



Penny Halgren is a quilter with more than 27 years of experience who loves to share her knowledge so your quilting journey is fun and stress-free.

Dear Quilter:

On a beautiful spring afternoon, five years ago, two quilters walked out of a Saturday quilt workshop. They were very much alike, these two brand new quilters. Both had previous sewing experience, both had the right tools for making quilts, and both – as new quilters are – were filled with images of beautiful heirloom quilts.

Last spring, these quilters met again at the local high school graduation. Both of them had grandchildren graduating that day.

The quilters were still very much alike. Both were very active in the community. Both maintained beautiful gardens. And both had continued making quilts.

But there was one big difference. One of these quilters made a beautiful family heirloom quilt in about one week for her grandson's high school graduation. The other quilter spent months of frustration trying to make a quilt for her grandson, gave up, and threw the jumbled up mess away.

### What Made the Difference?

Have you ever wondered, as have I, what makes this kind of difference in quilters' progress? I've worked with hundreds of quilters and I can assure you it isn't always native intelligence or talent or dedication. It isn't that one quilter wants success more than the other.

The difference is that successful quilters seek out expert advice and shortcuts while they interact with other successful quilters. And that's what TheQuiltingCoach.com is all about.

Your success as a quilter is why TheQuiltingCoach.com was created: To give quilters like you inspiration and knowledge – inspiration and ideas for beautiful quilts they can make, free patterns to make beautiful quilts, and knowledge you can use to make beautiful quilts with ease.

*"Hi, Penny I love this site! All the fabulous info in it is just what I need."*  
**Trudie Abday, Edmonton Alberta, Canada**

### A Quilting Resource Unlike Any Other

You see, TheQuiltingCoach.com is a unique quilting resource. It's the only community that is totally focused on delivering the exact quilting information that gives you the skills to quickly create beautiful quilts. You'll astonish your family in no time!

Here is what another member has to say:

*"Penny, bless your heart for helping turn the light on over my head on how to become more efficient at this new love of mine!"*  
**Patty Macfarlane, Palmdale, California**

### Get Your Questions Answered

When you visit TheQuiltingCoach.com, you'll see that it is jam-packed with resources:

- **You'll always have inspirational ideas:**
  - with the hundreds of Quilt Block Patterns
  - quilt galleries to see what other quilters have done
- **Your quilting will be stress-free:**
  - know exactly what to do next using the in-depth step-by-step guides for making quilts and quilt blocks
- **You will save time making your quilt:**
  - hundreds quilting tips and shortcuts at your fingertips
  - easy to find with the powerful search features on the site
- **Your fears will melt away:**
  - watch the video clips showing quilting techniques
- **You will be the envy of your family and quilting friends:**
  - personal access to internationally-known quilters in our Eavesdrop on a Telephone Conversation series
- **And much, much more**

Most of the information appearing in TheQuiltingCoach.com appears *nowhere else*. And because this is an internet resource, the information is updated throughout the day, giving you clear tips and step-by-step instructions.

**YOU DESERVE THE ULTIMATE!**

**45 Day Test Drive for Just A \$1**

Put our statements to the proof by joining for the next 45 days for just \$1. You just can't lose. After the initial trial period ends, your monthly investment is just \$24.97.

*"When I have been having problems getting in the mood to work on my quilts that I am committed to finishing by August I just have to check in at the quilting site and I'm back in the mood. It has been wonderful."  
Anna Lacey, British Columbia, Canada*

Simply visit us online at [www.TheQuiltingCoach.com](http://www.TheQuiltingCoach.com), click on the secret red button marked "45," enter your information, and you will have immediate access to all of the resources on the site.

***TheQuiltingCoach.com Guarantee***

Should TheQuiltingCoach.com not measure up to your expectations, you may cancel at any point and keep all of the free quilting resources you received; whether it is one day or one decade from the time your trial begins.

**No Weasel Clauses. No Hard Feelings. No Hassle.**

I really pour my heart and soul into the site to make it the perfect resource for you to ensure your quilting success.

So, which quilter are you going to choose to be, the successful one or the one who quilts in frustration?

**An Investment in Success**

I can guarantee you that you will find TheQuiltingCoach.com always bulging with great quilting information and inspiration for making beautiful family heirloom quilts. Quilts maybe you thought you could never make.

Happy Quilting!

*Penny Halgren*

Penny Halgren



P.S. Remember to use the special red button at: [www.TheQuiltingCoach.com](http://www.TheQuiltingCoach.com) to receive this special trial membership offer. You won't find it anywhere else on the site.

P.P.S. Take a look at some of the quilts made by members of TheQuiltingCoach.com:



*"Thanks for all the great info I have had access to since I joined this site. I love it!"  
Anna*

# Pieced Tulips Block

Key Block (7/20 actual size)

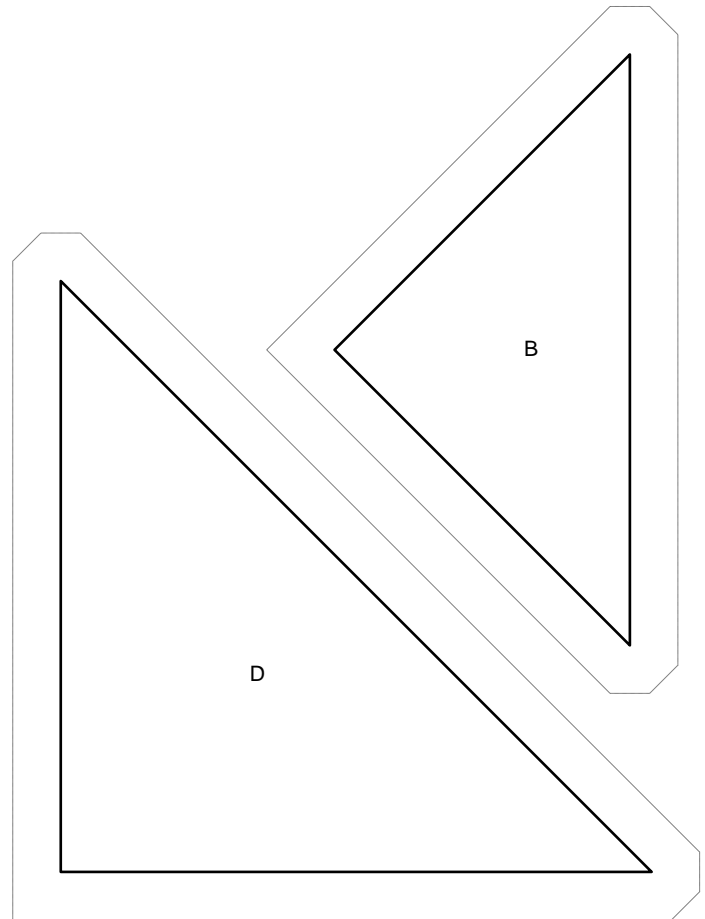
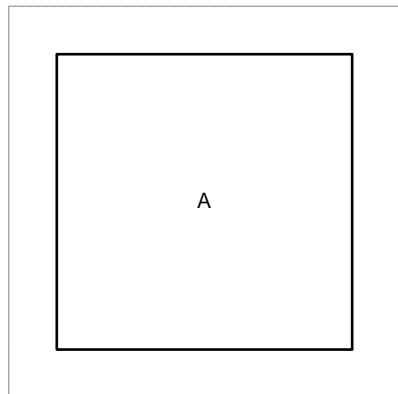
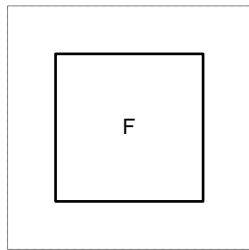
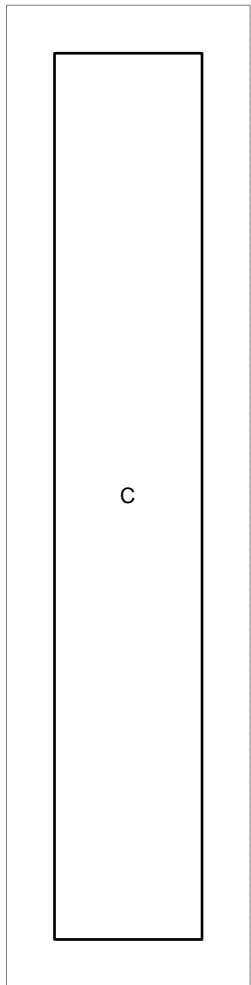
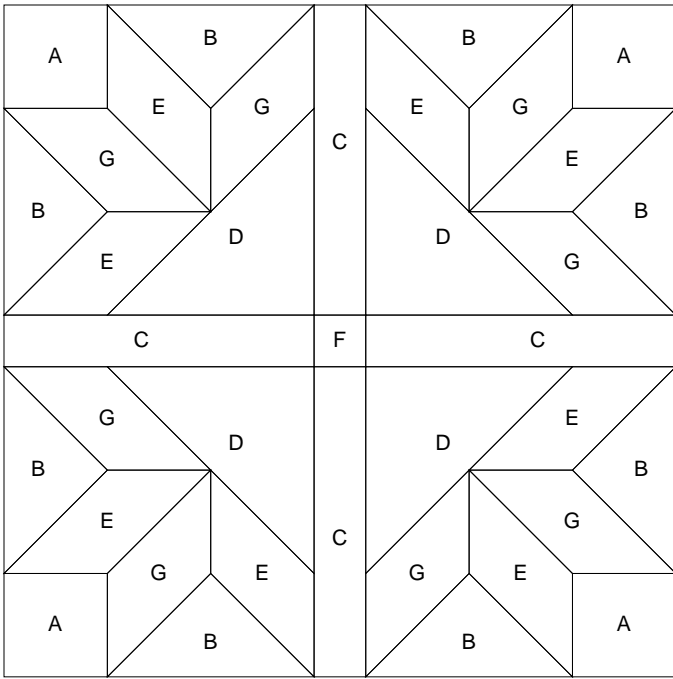

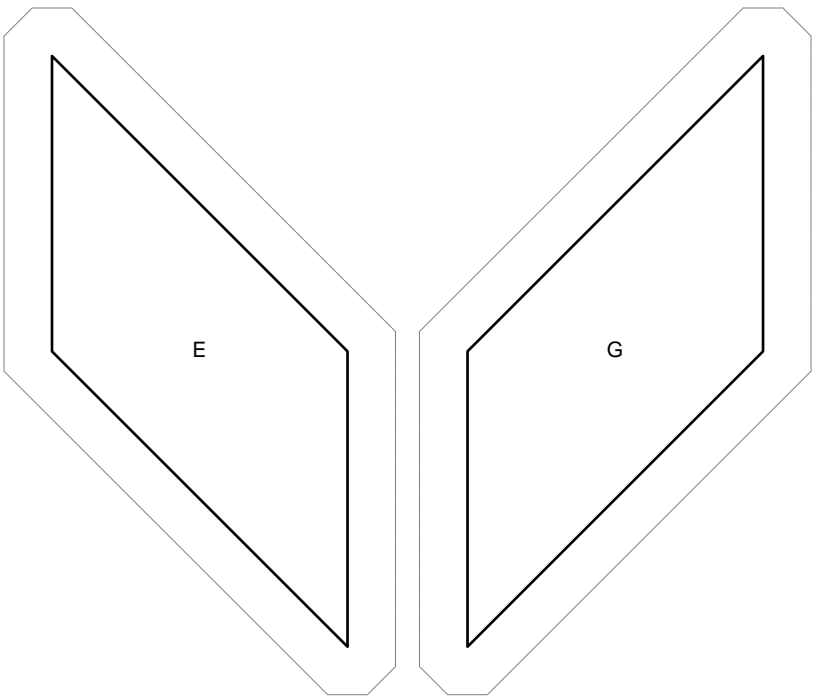

# Pieced Tulips Block

Key Block (5/20 actual size)

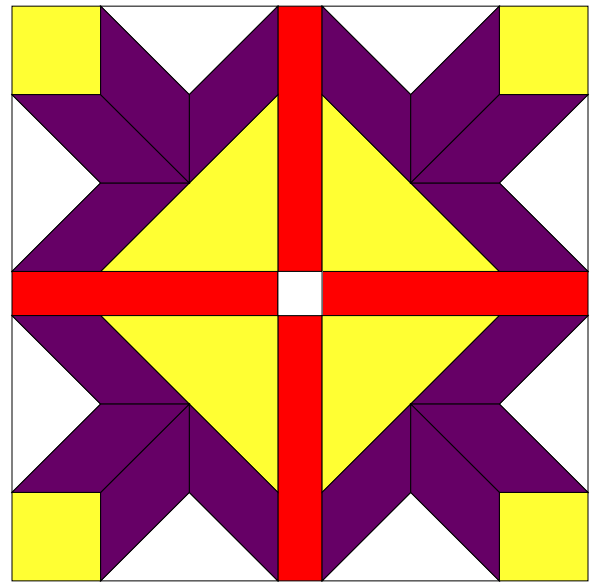
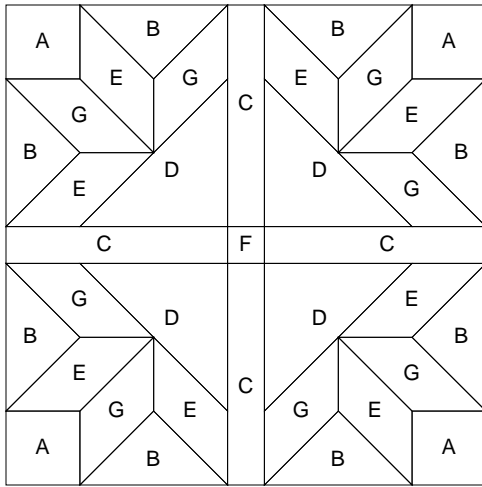

## Cutting Diagrams

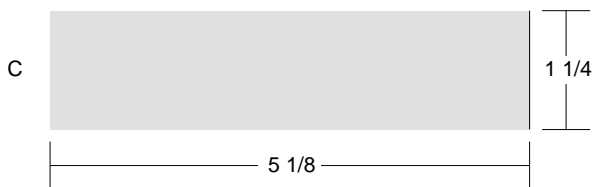
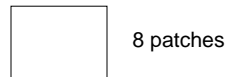
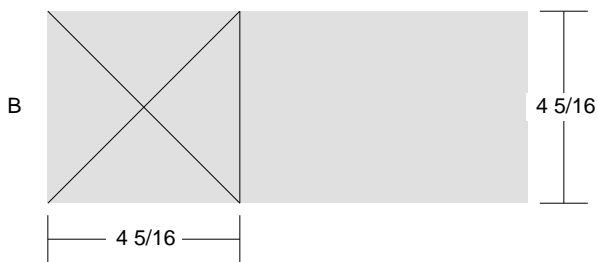

## Patch Count

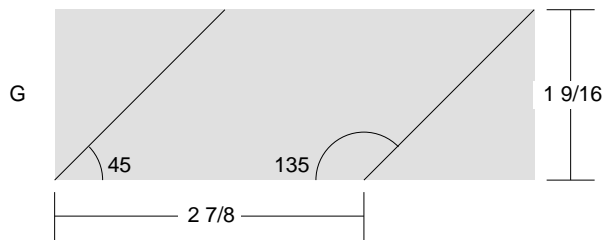
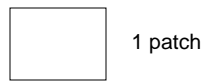
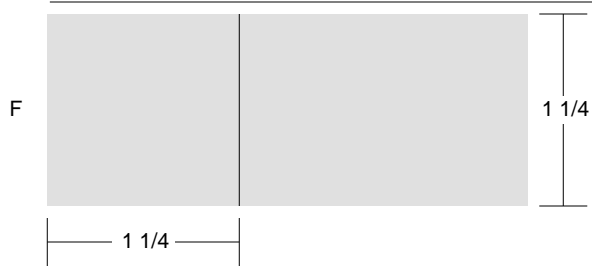
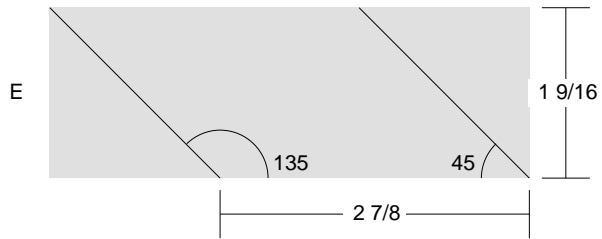
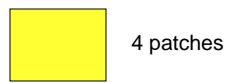
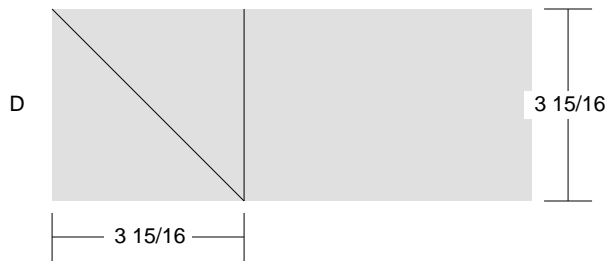

Signature

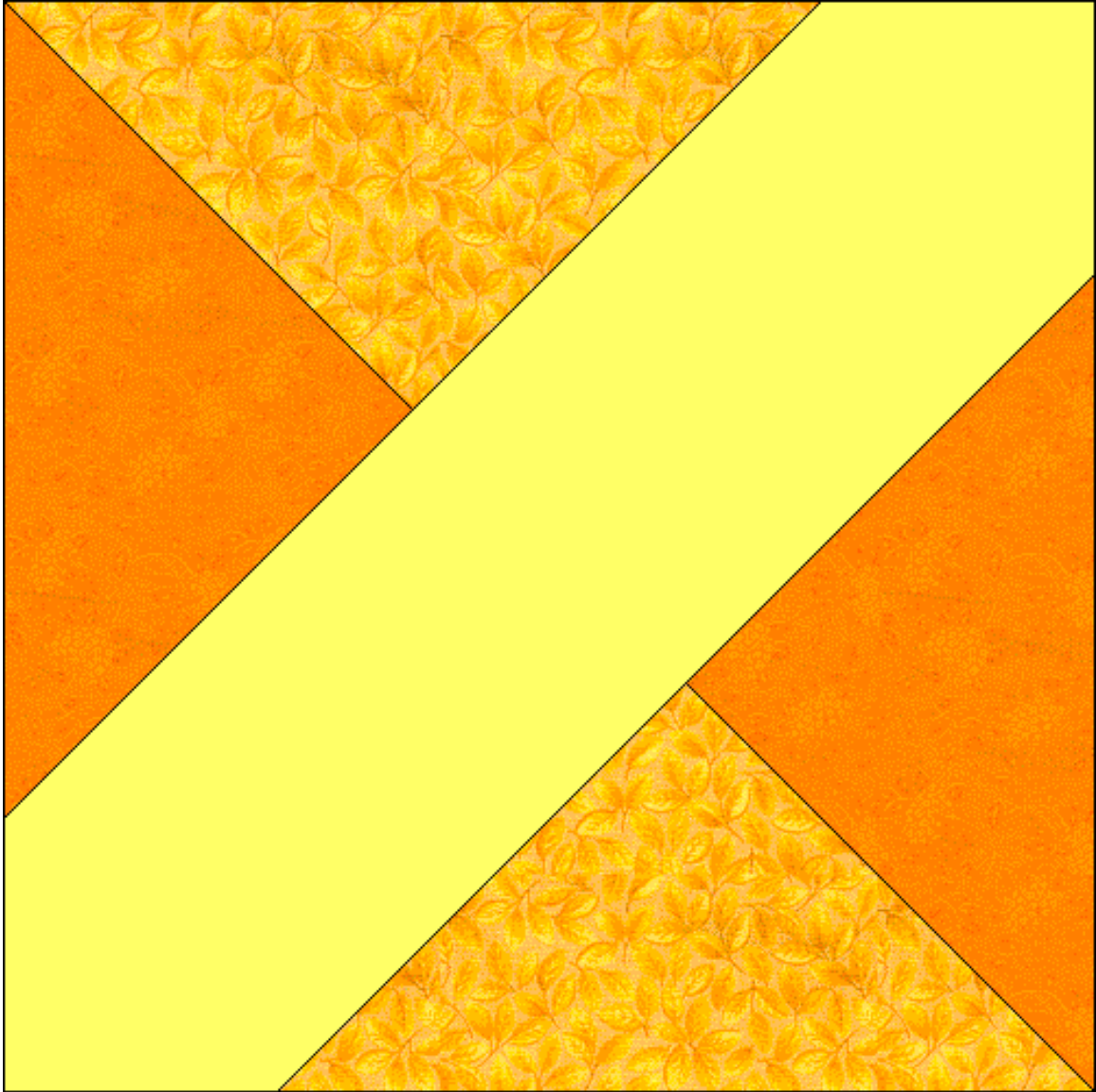

Signature  
Pattern for 8.00x8.00 block  
Key Block (43/100 actual size)

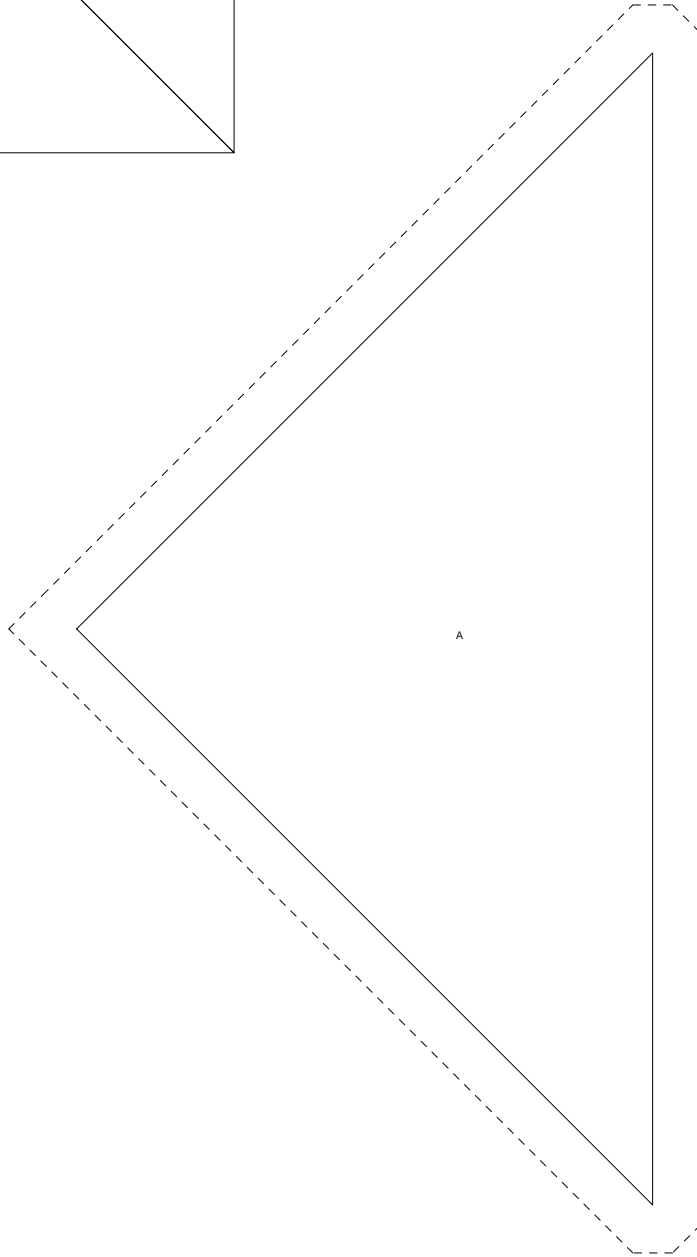
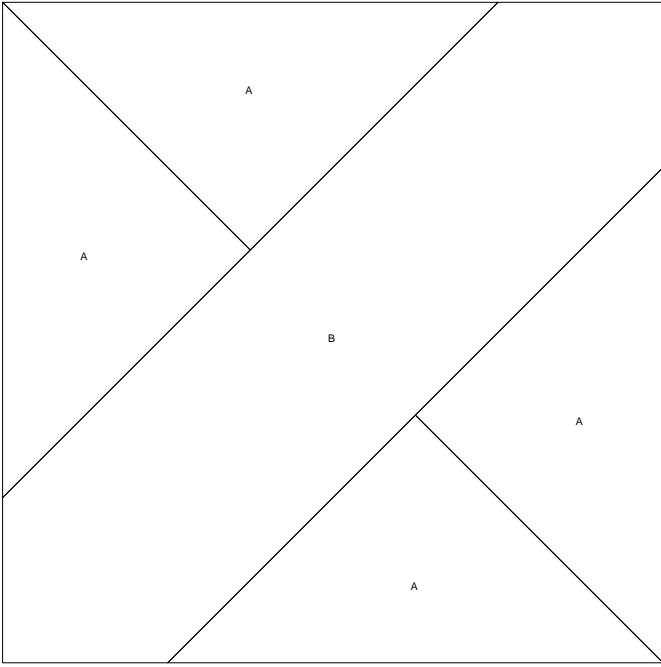

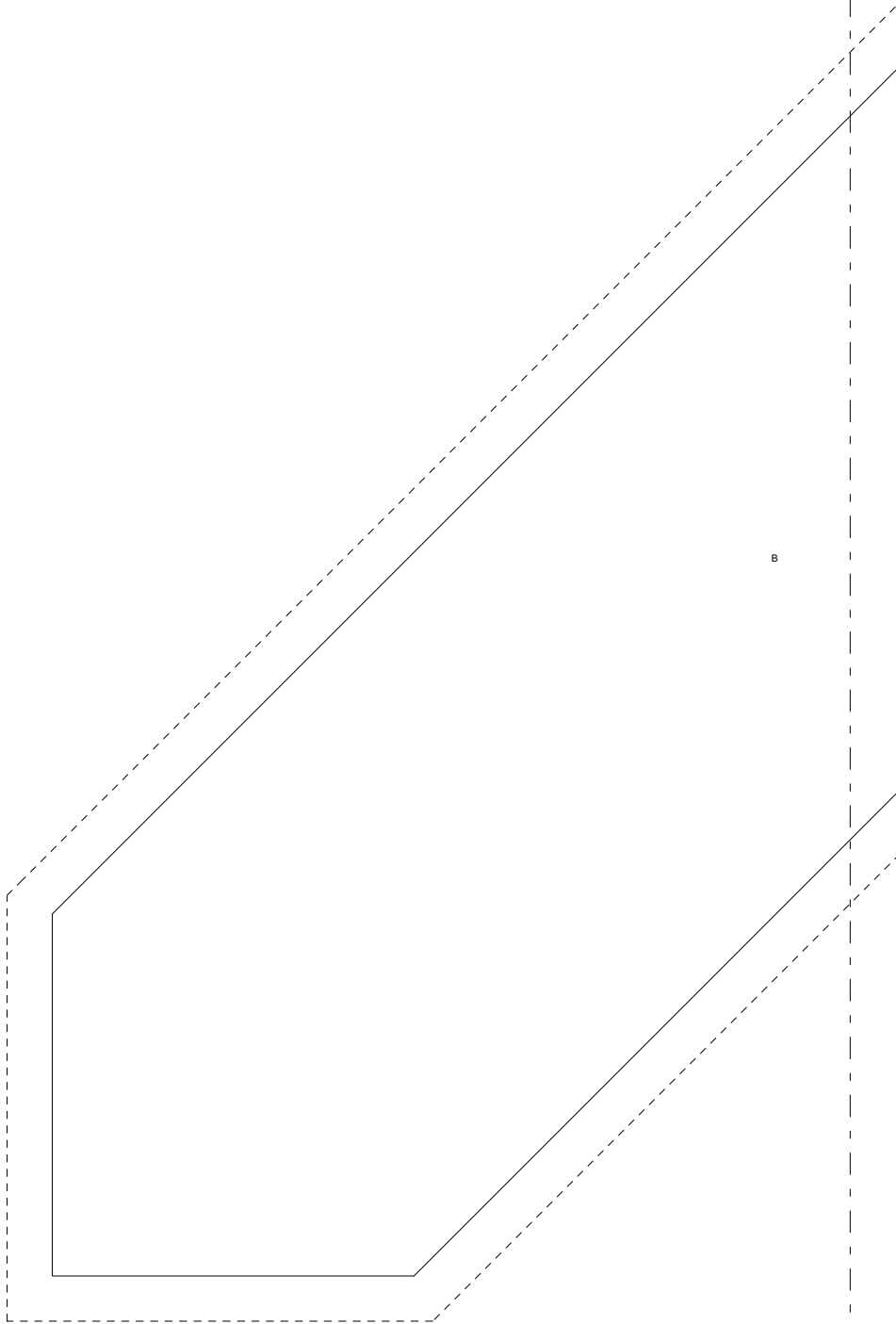

B

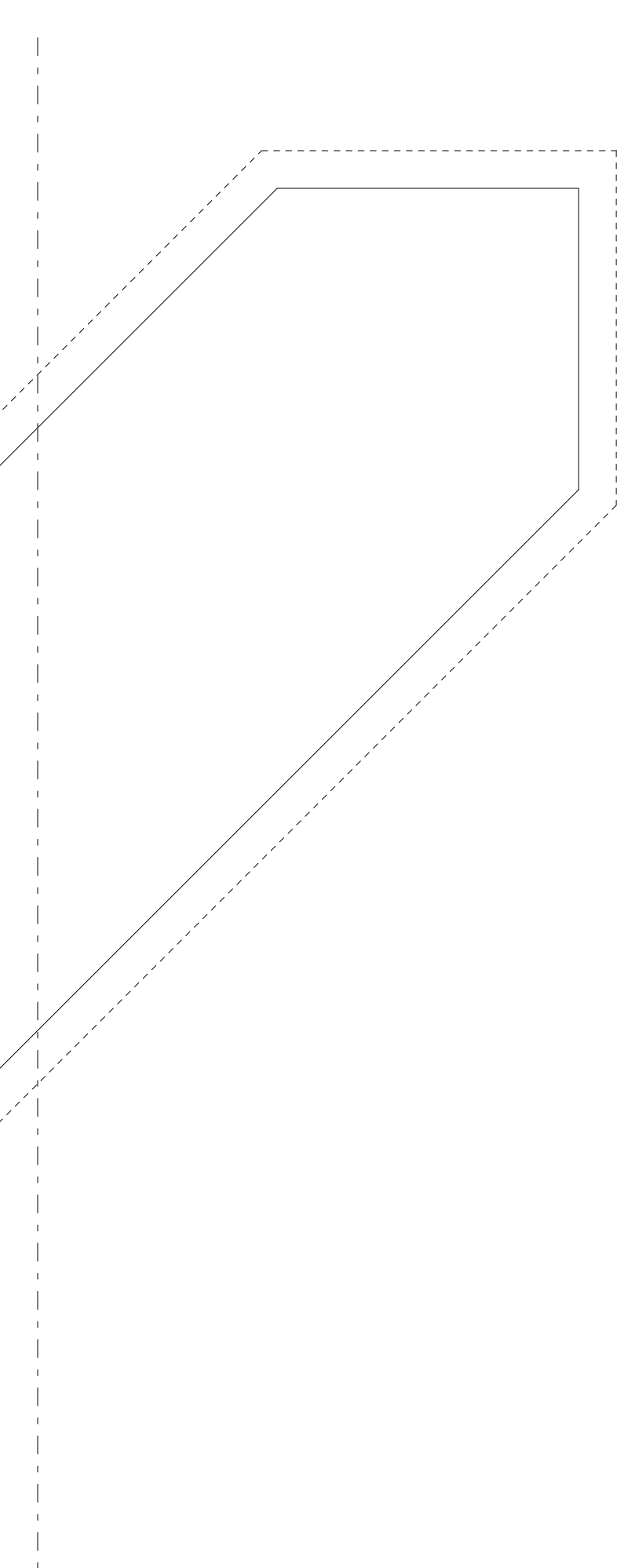

Signature  
Pattern for 8.00x8.00 block  
Key Block (31/100 actual size)

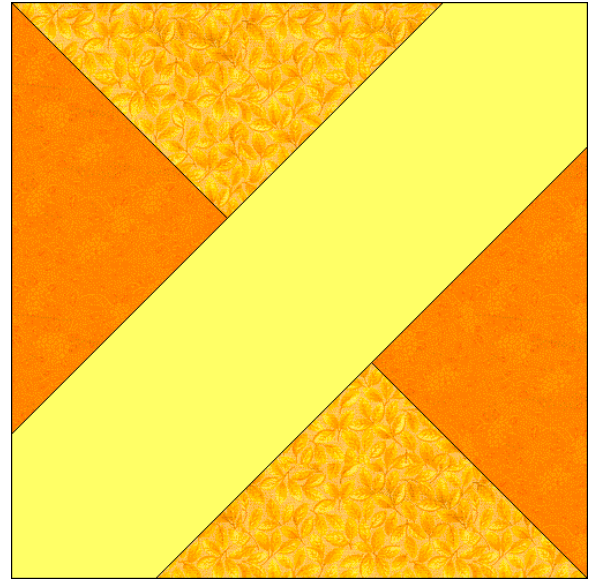
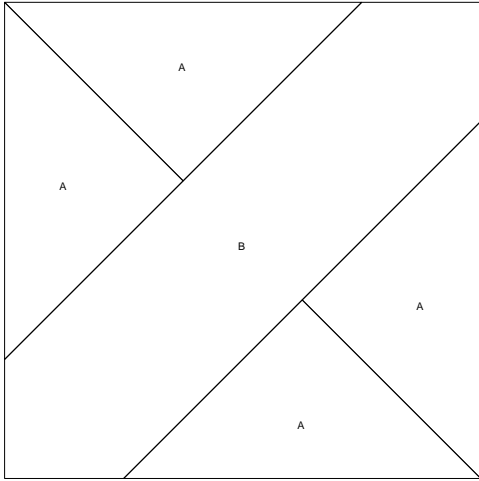

Cutting Diagrams

