

July 2010 Block Patterns

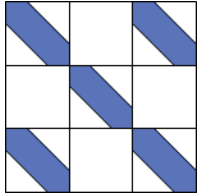

Broken Paths

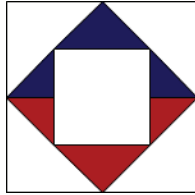

Checkerboard Quilt

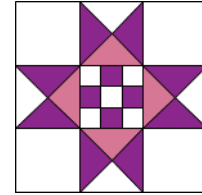

Dolly Madison's Star

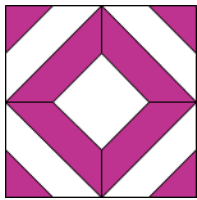

Fancy Stripe

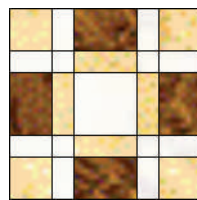

Handweave

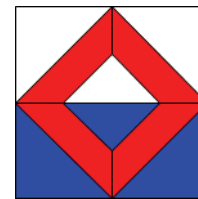

Linking Blocks



Red, White and Blue

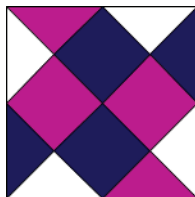

Shooting Squares

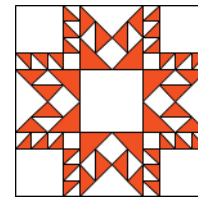

Star Diamond

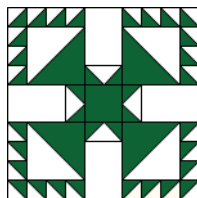

Uncle Sam's Favorite

Banish Boring Binding. Forever!



Now You Can Bind Any Shape Quilt or Make Plain Binding Spectacular on a "Normal" Shaped Quilt

**Using This Brand New Quilting Resource, Your Binding Will "WOW!"
Your Family and Friends - and Your Boring Binding Days will be Gone Forever.**

Do you have **quilts that are waiting to be finished** because you are looking for a special way to bind them?

Oh - you've seen the regular binding on a quilt - double fold bias binding with mitered corners; self-binding where you fold the front of the quilt around to the back or the back of the quilt around to the front; knife edge binding - where you simply stitch around the outside of the quilt - but **this quilt is special**, and you need an extraordinary kind of binding. And you want it to be **beautiful and easy to add!**

Maybe this is the first quilt you have finished that has **curved edges**, and you aren't sure how to add the binding so it will be nice and smooth both around the curves and inside the corners. Possibly you are looking for some inspiration and a **new type of binding** that will make your quilt look really unique, and you just don't know where to look.

Or are you secretly looking for some out of the ordinary way to finish your quilt that will impress your family and friends so they will **finally know that you really have some quilting skills** - and that this isn't some trial and error thing that you are still trying to figure out? (Shhh . . . It's OK, we've all been there and we won't tell - it's a little quilters' secret!)

Now you can add 7 more methods for binding a quilt to your Quilting Toolbox. No kidding! In the Creative Binding DVD Mentor, you will get all of your nagging questions answered about binding and how to bind a quilt. Questions like:

- Which is better? Bias to Straight grain?
- How do you miter the corners so they are flat and professional-looking?
- How do you sew the ends together so you have a smooth finish?
- How wide should your binding be?
- How do I bind a quilt with curved edges or inside and outside corners?
- How do I bind a quilt with something really fun?



In this fantastic quilting resource, you get DVDs and a Guidebook showing you:



- ⇒ Double Fold Straight Grain Binding
- ⇒ Binding a Quilt with Curves
- ⇒ Striped Binding
- ⇒ Binding with Prairie Points – 2 different ways
- ⇒ Binding a Quilt with Inside and Outside Corners
- ⇒ French Fold Binding
- ⇒ Reversible Binding

I know how frustrating it is to learn something new, especially when there isn't an expert sitting right there showing the next step and explaining it so anyone can understand. You should have been inside my head the first time someone explained how to stitch the ends of the binding together on the machine.

Using this quilting resource, you can watch as the binding is added to the quilts, and when it's your quilt, you'll know exactly what to do and how to do it.

www.creative-binding.com

Penny Halgren - www.How-to-Quilt.com - www.TheQuiltingCoach.com

Broken Paths! - 'j'bw 'V'cW

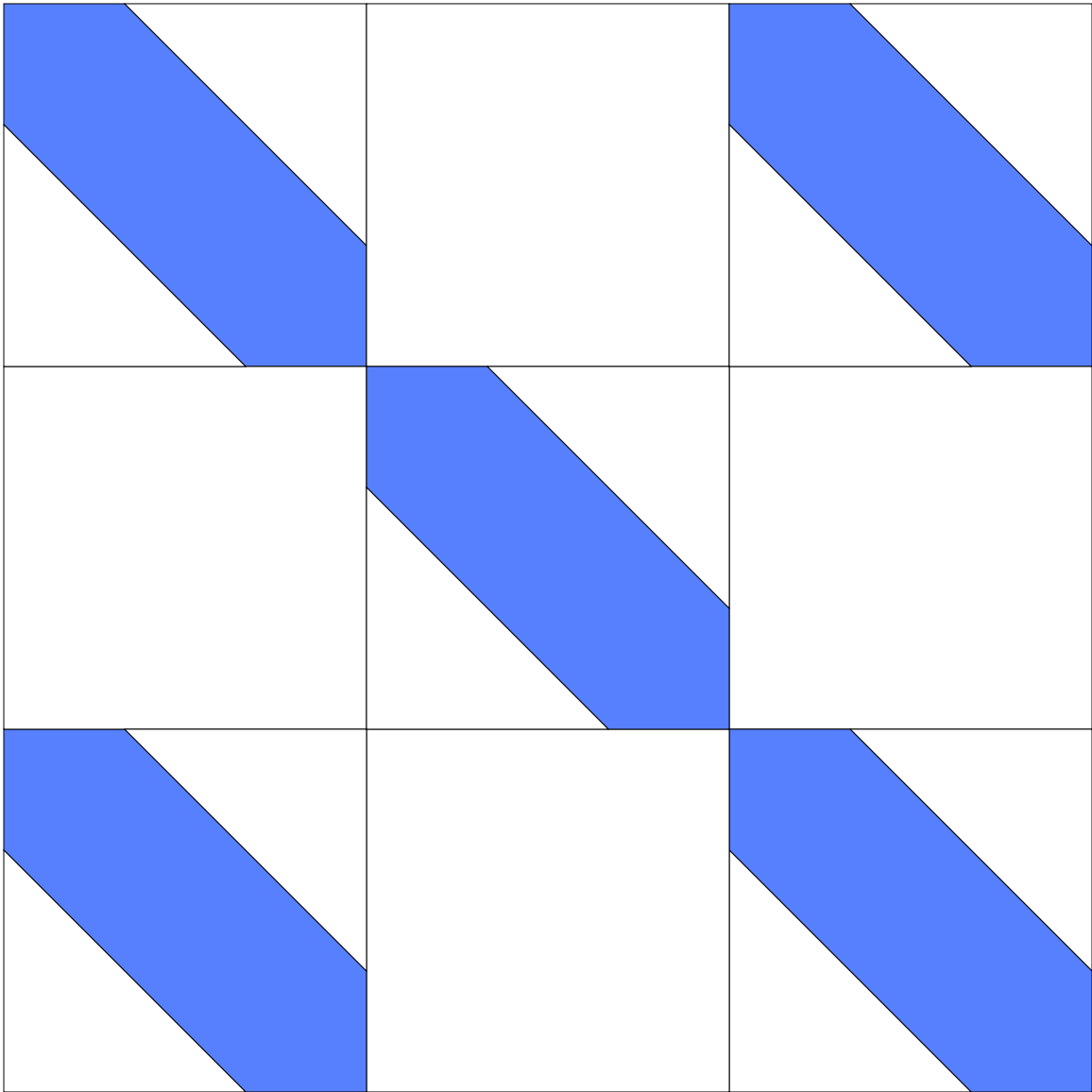

Broken Paths

Key Block (19/50 actual size)

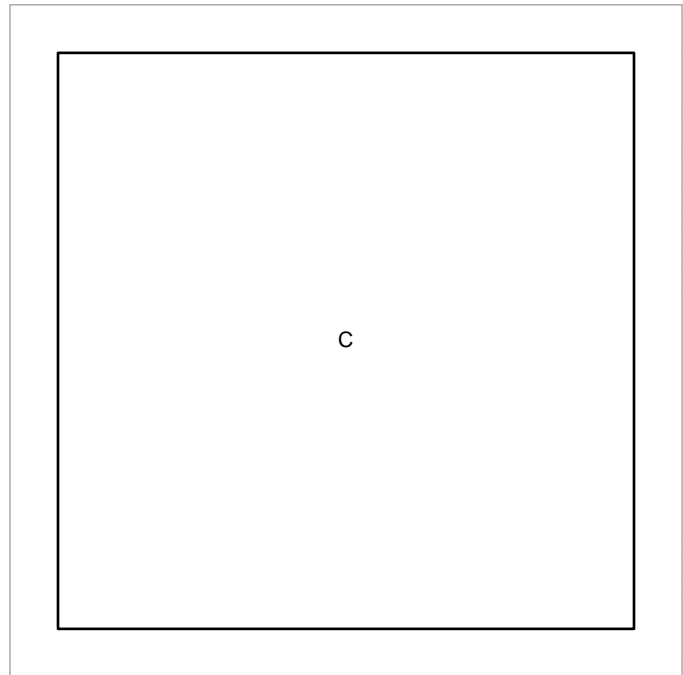
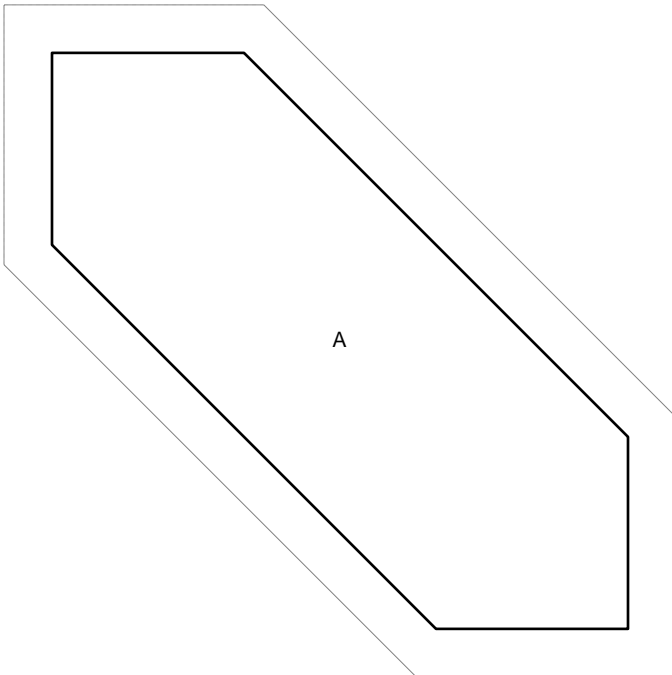
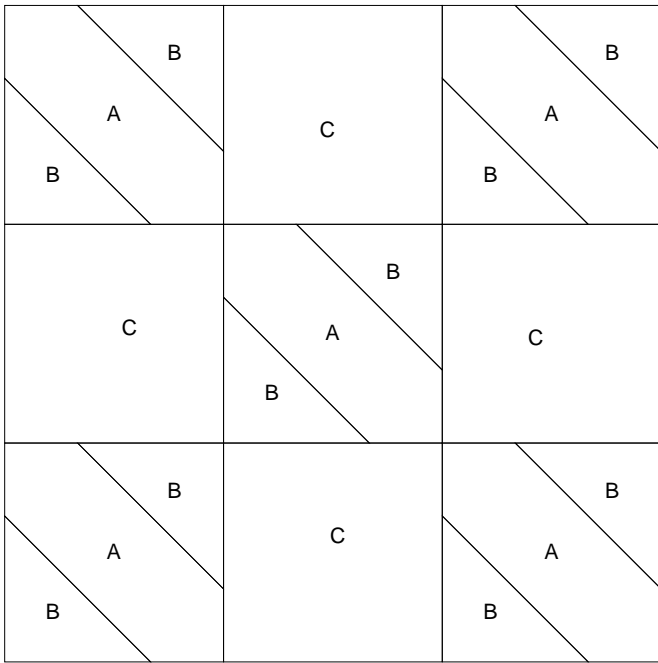

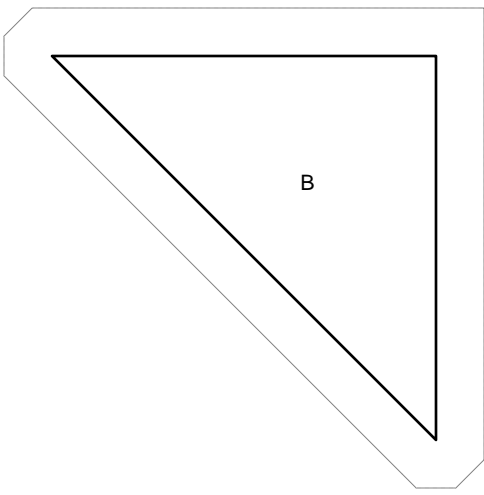

Broken Paths

Key Block (27/100 actual size)

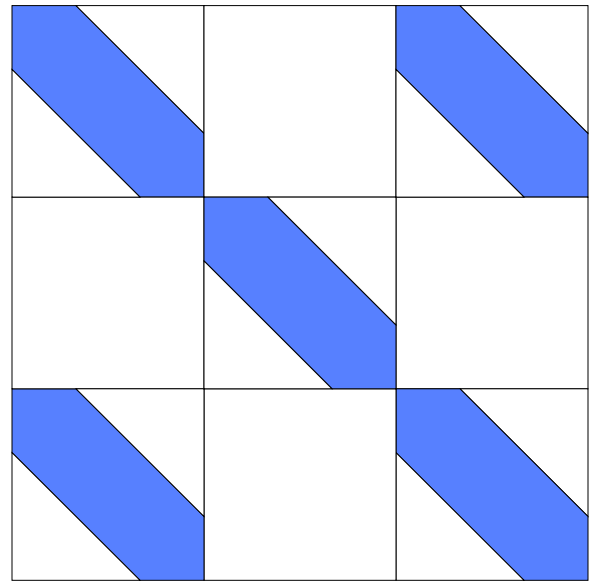
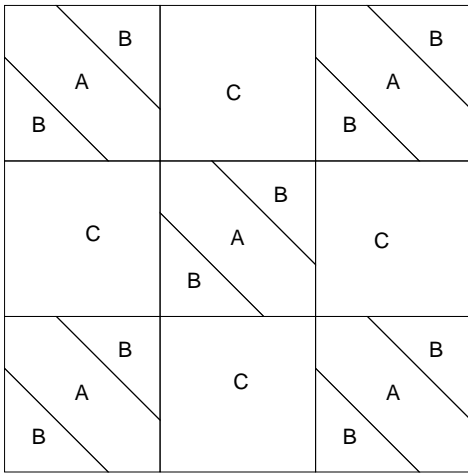

Cutting Diagrams

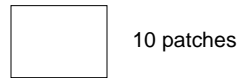
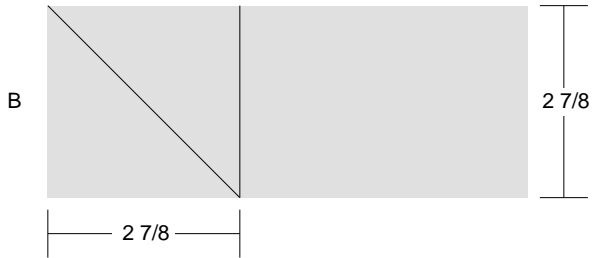

Patch Count

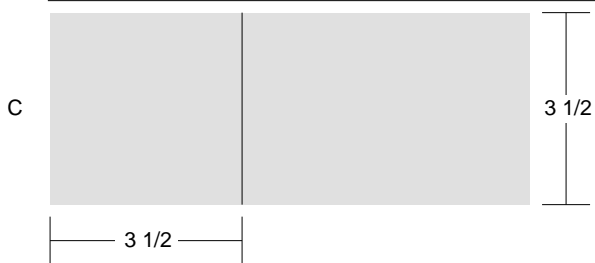

Checkerboard Quilt', 'jW 'cW

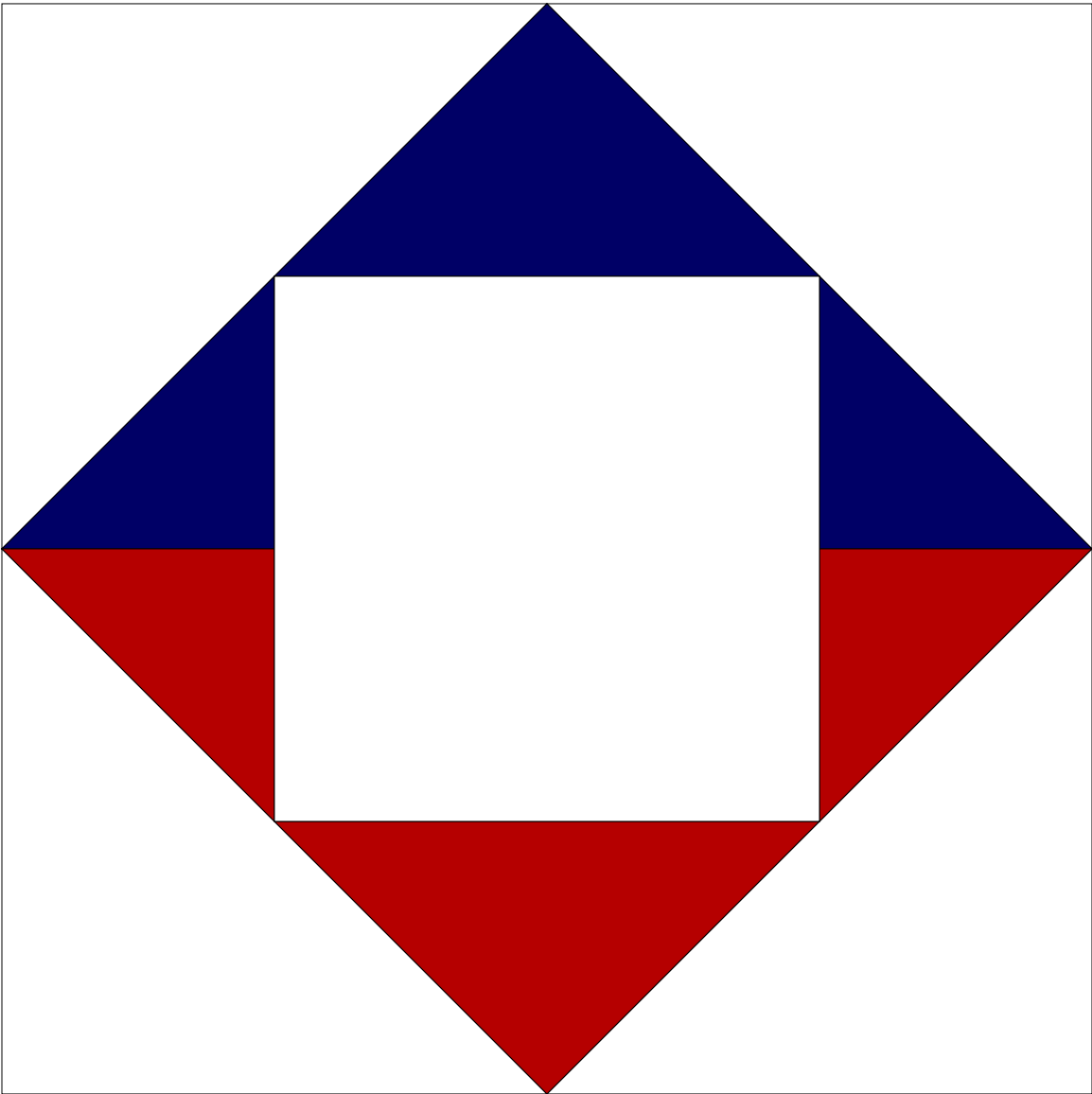

Checkerboard Quilt

Key Block (43/100 actual size)

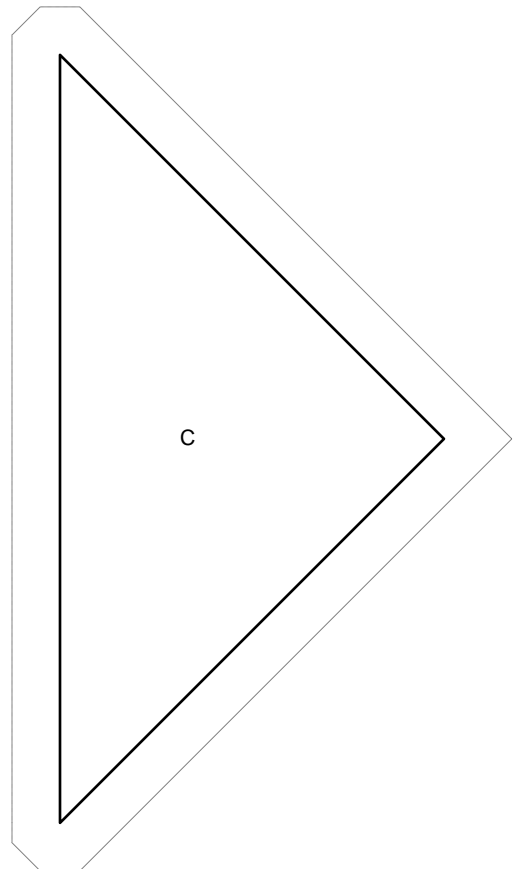
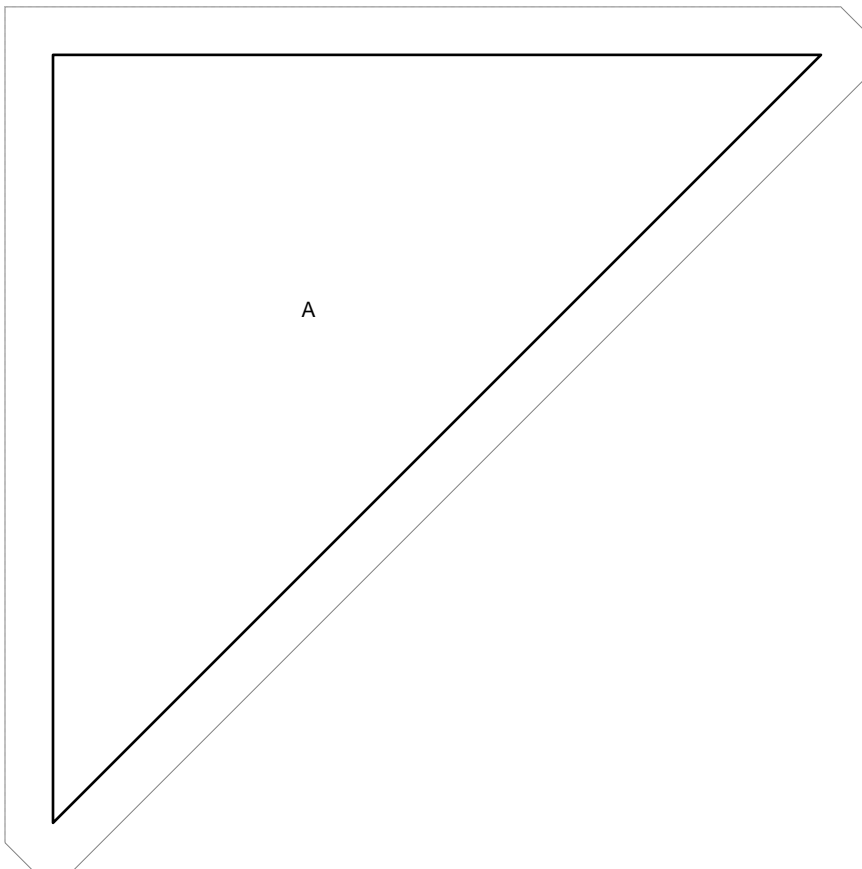
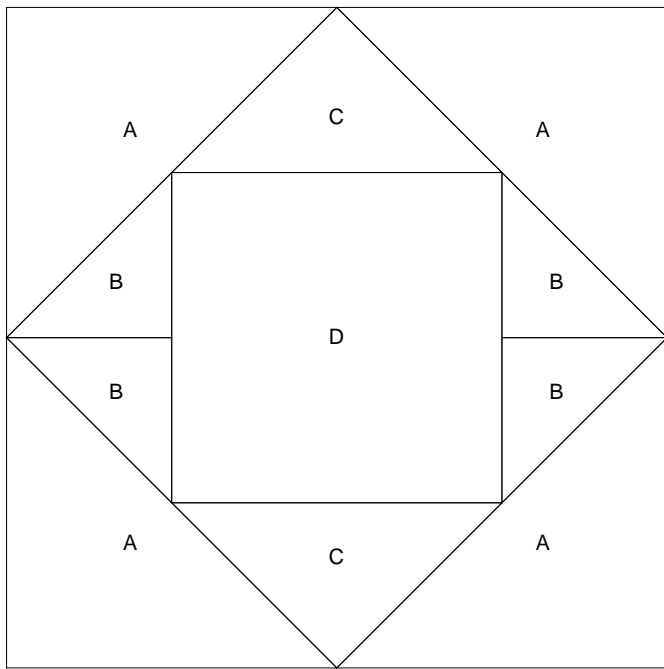

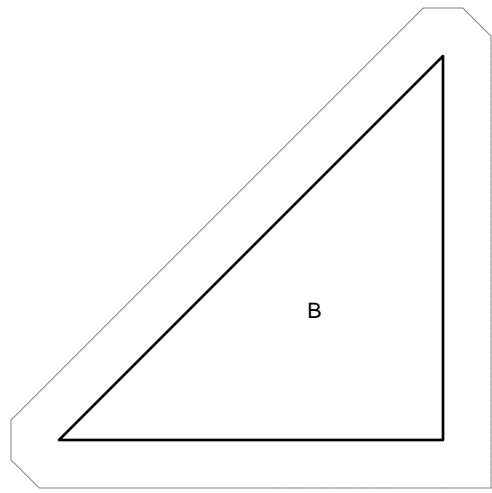
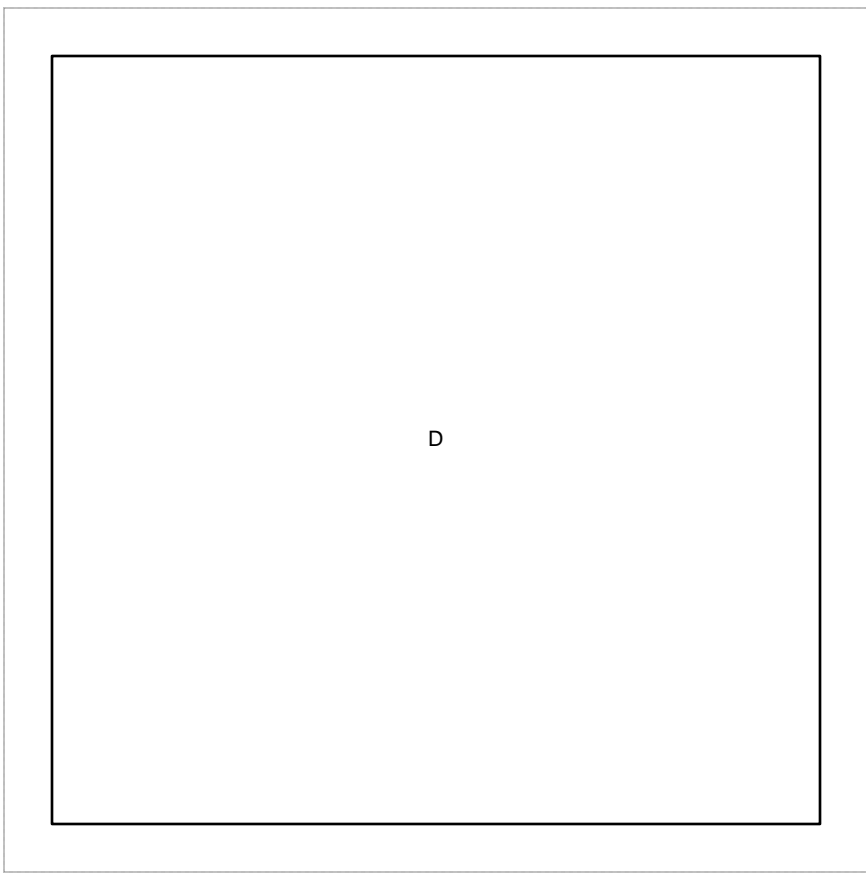

Checkerboard Quilt

Key Block (31/100 actual size)

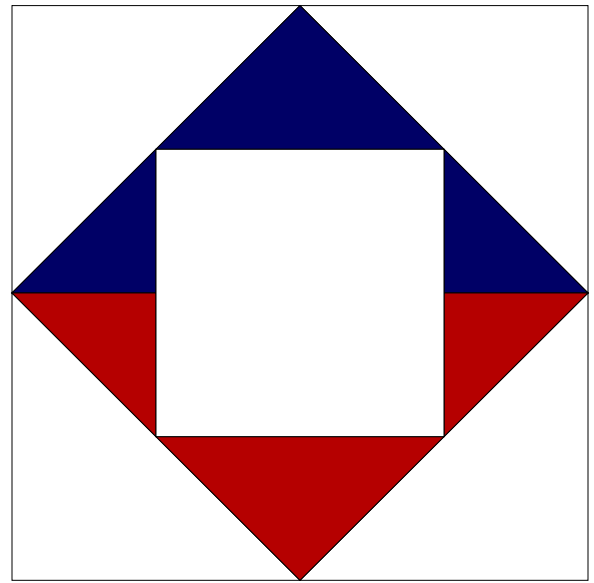
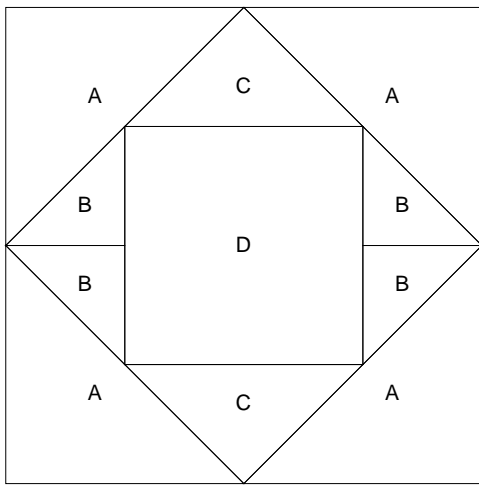

Cutting Diagrams

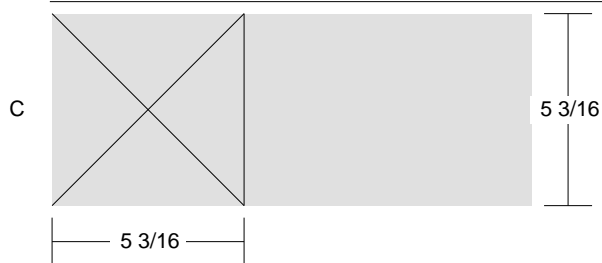
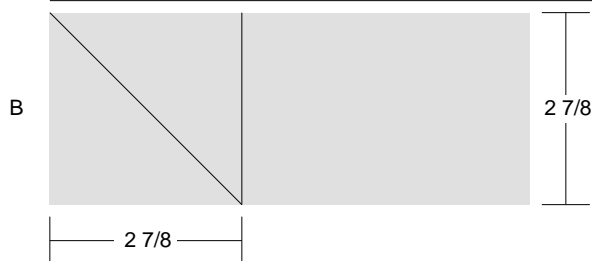
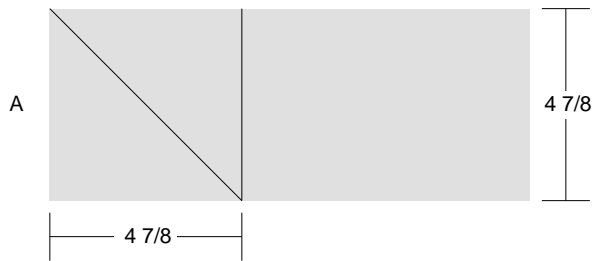

Patch Count

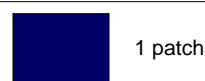

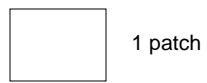
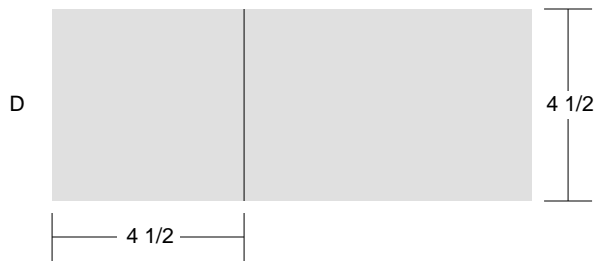

Dolly Madison's Star! -]bW `VcW_

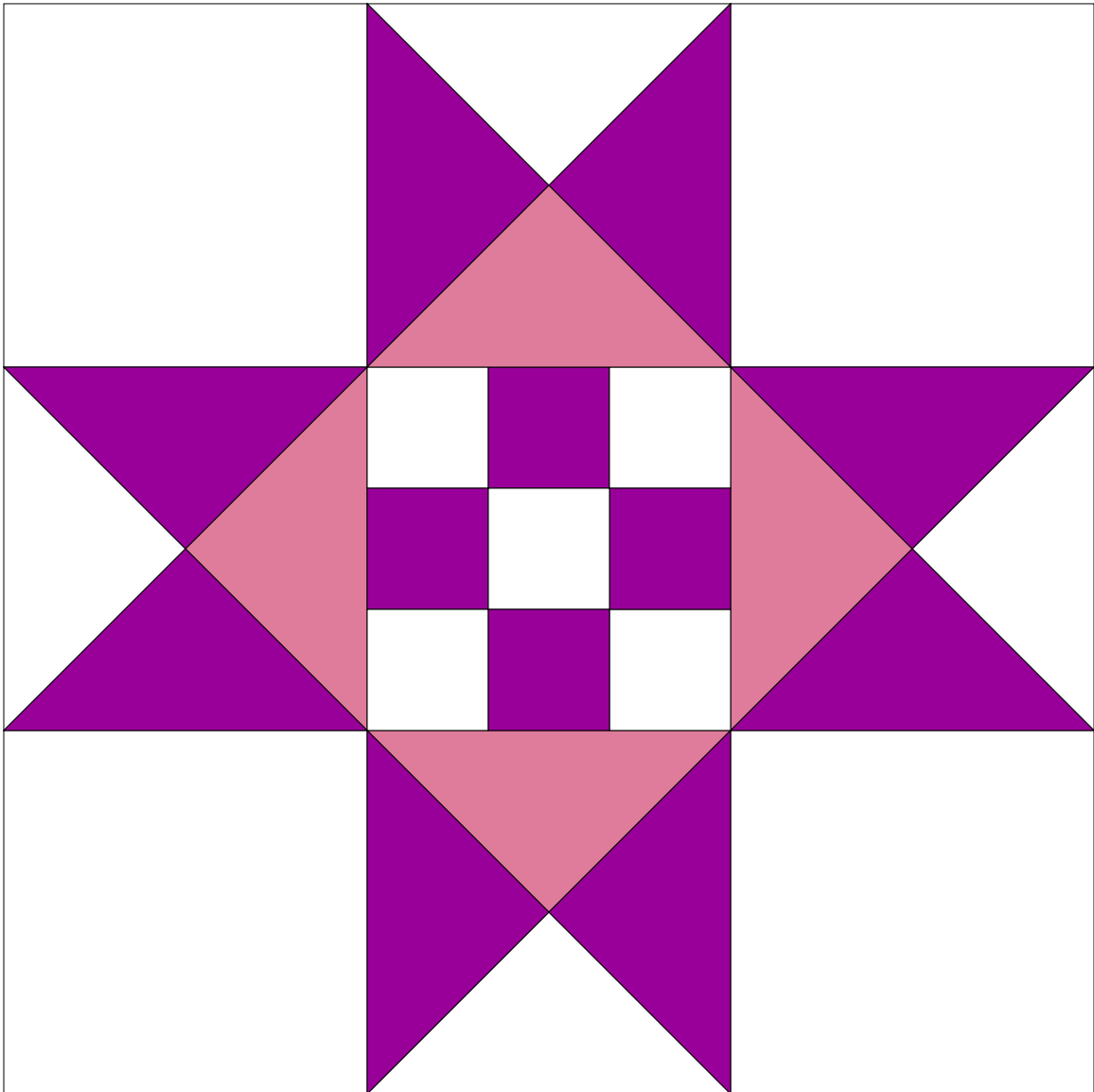

Dolly Madison's Star

Key Block (19/50 actual size)

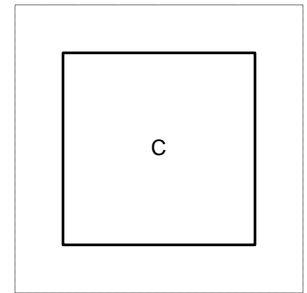
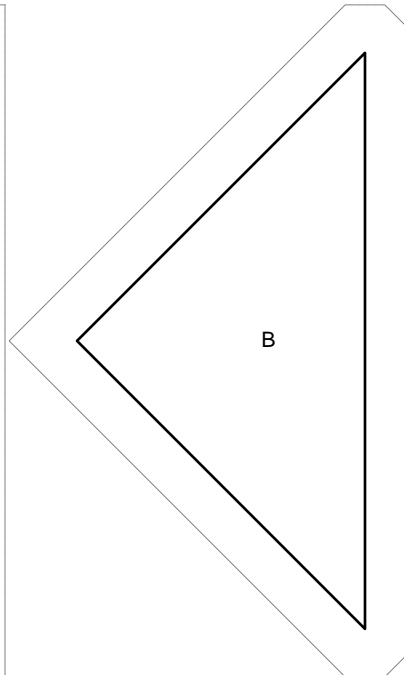
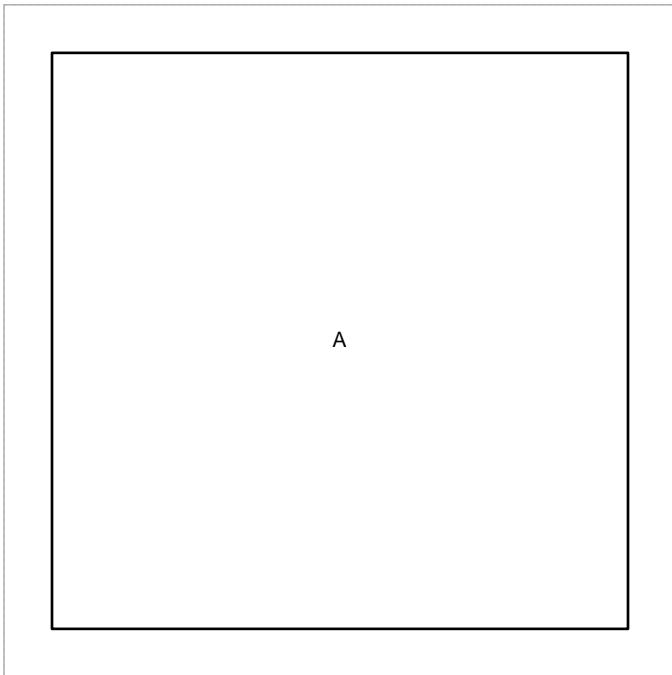
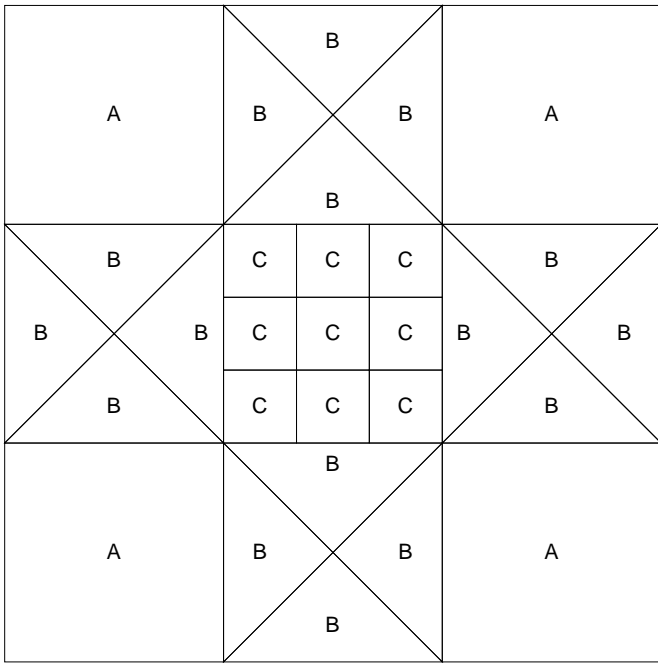

Fancy Stripe

Key Block (31/100 actual size)

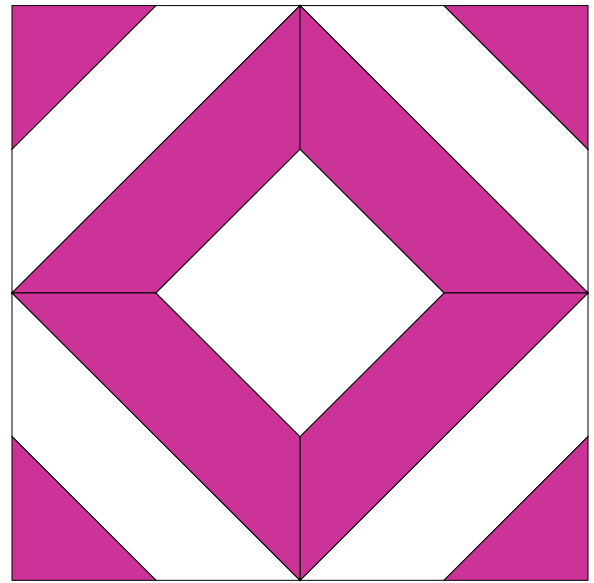
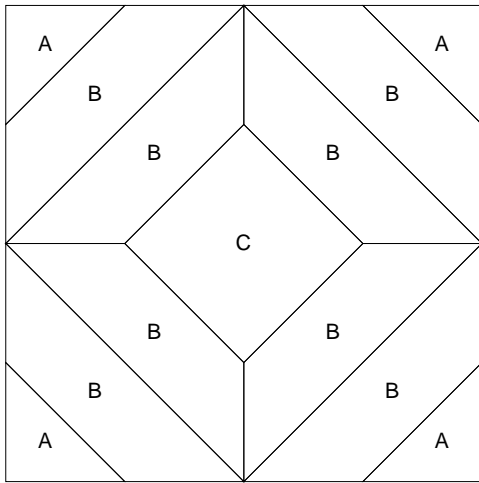

Cutting Diagrams

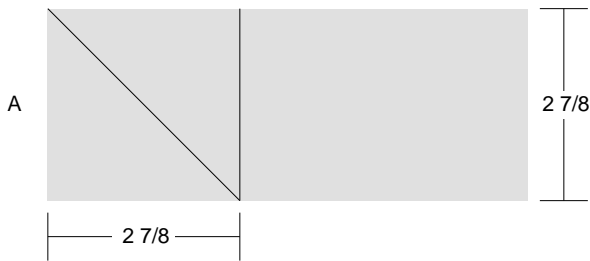

Patch Count

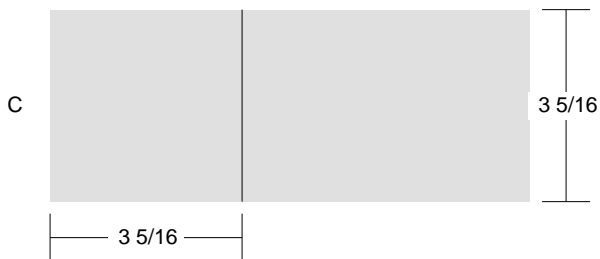
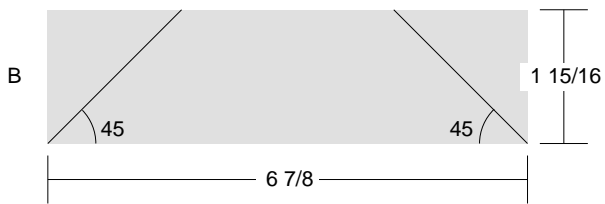

Fancy Stripe!', 'jW 'VcW_

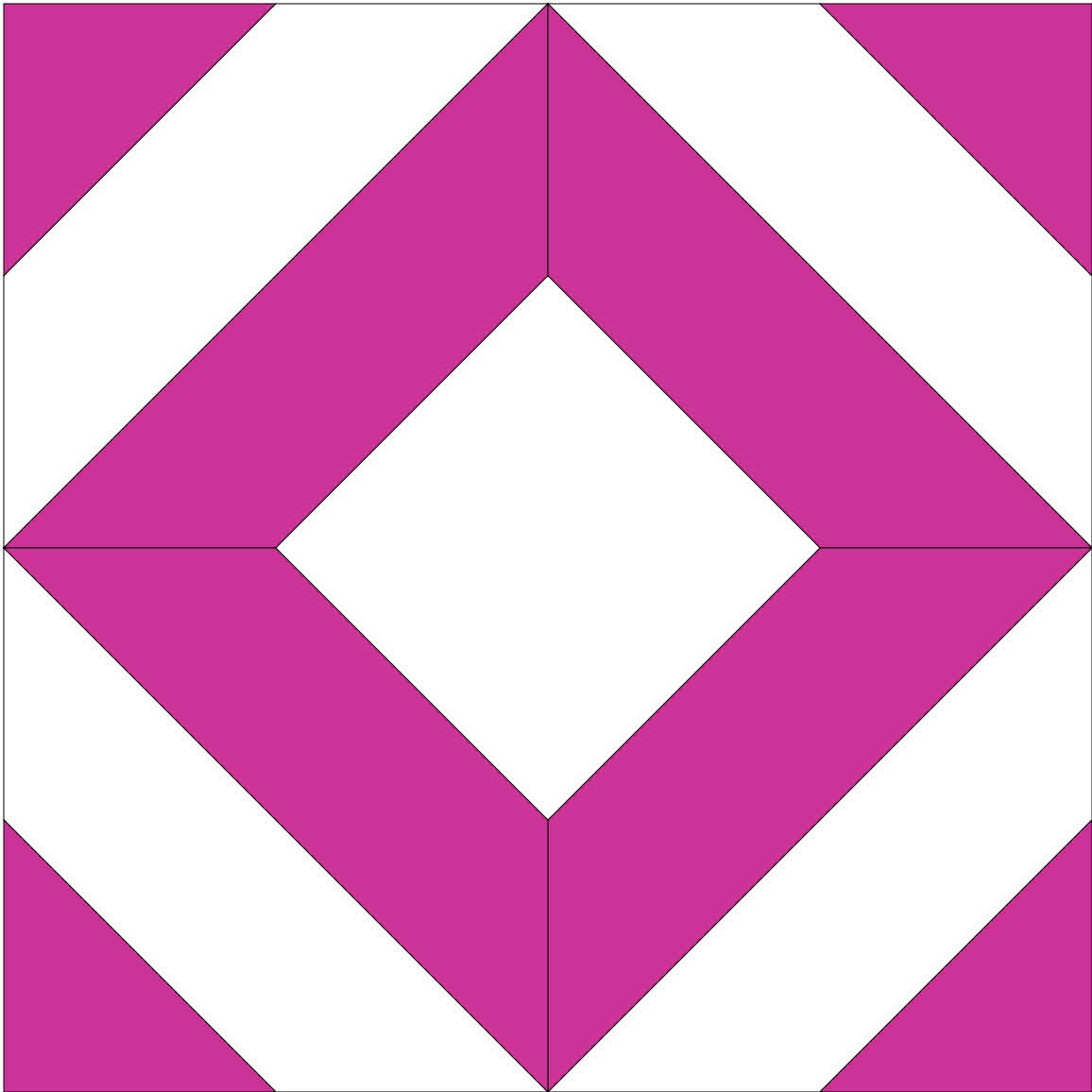

Fancy Stripe

Key Block (43/100 actual size)

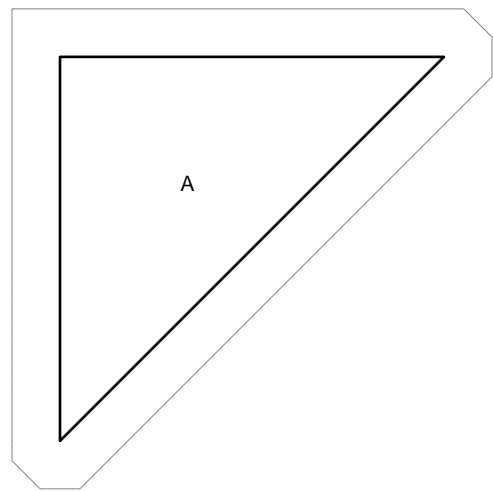
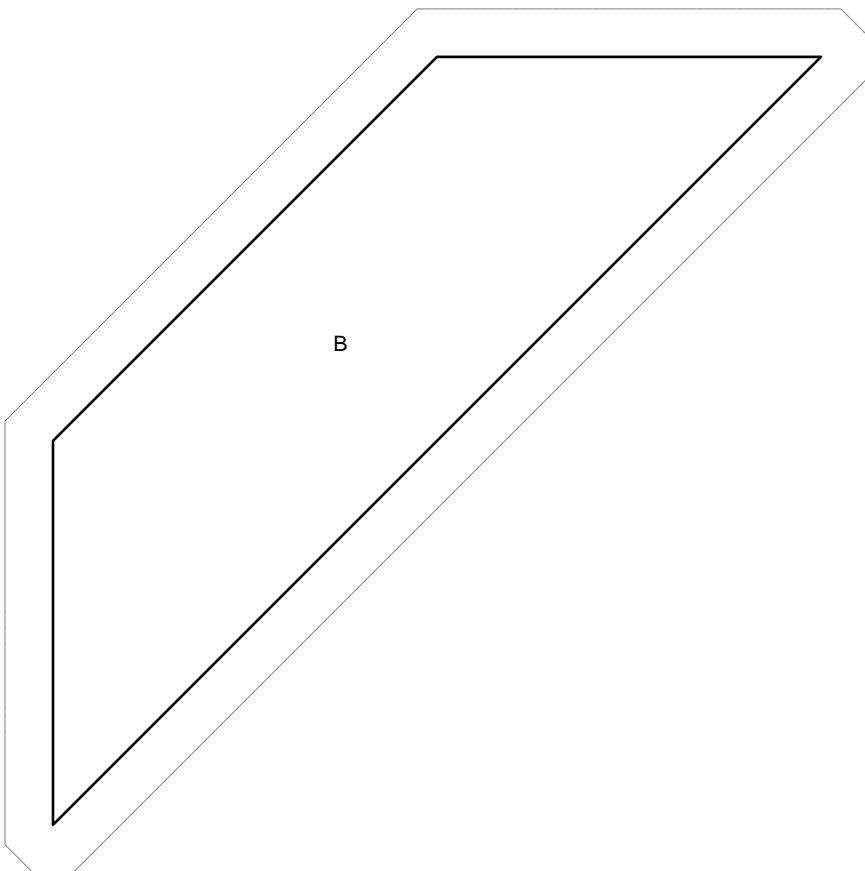
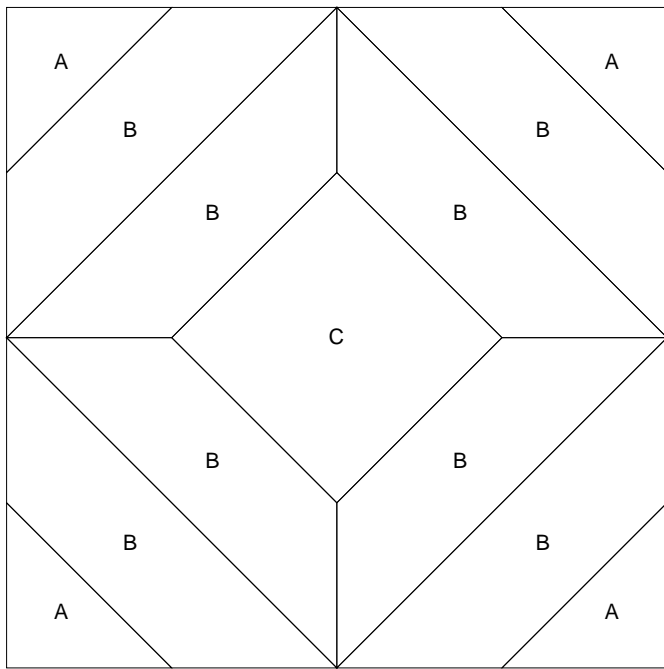

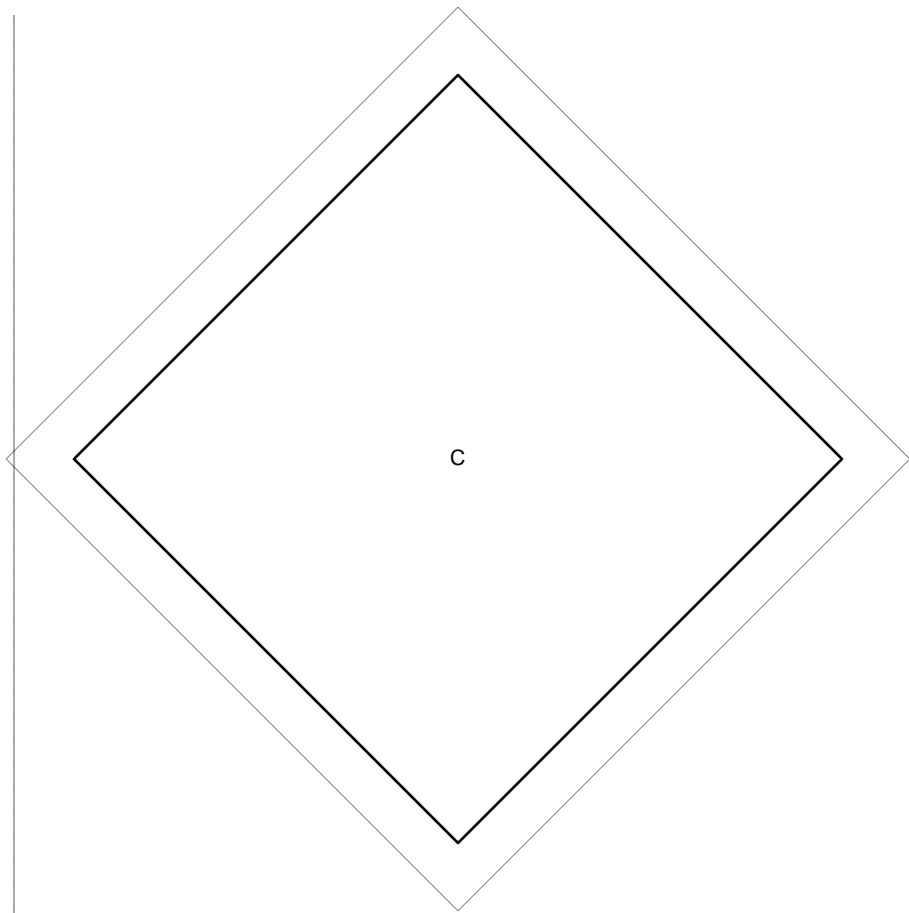

Fancy Stripe

Key Block (31/100 actual size)

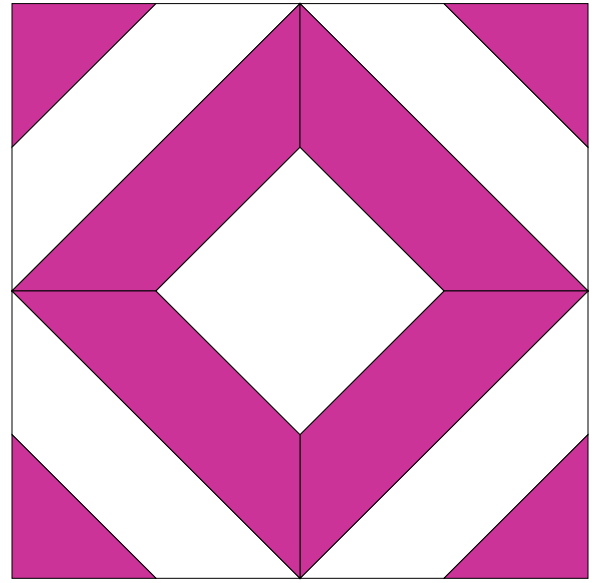
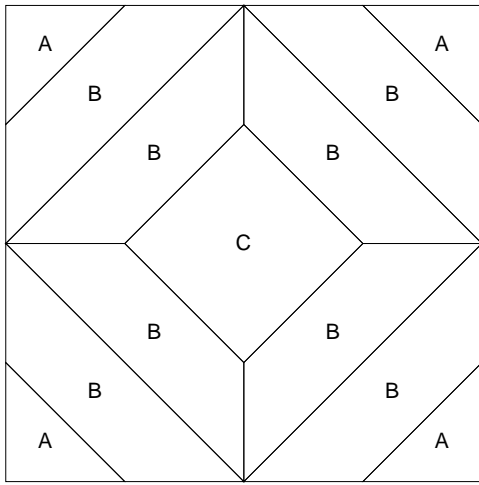

Cutting Diagrams

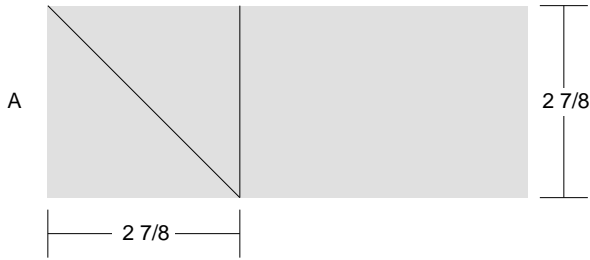

Patch Count

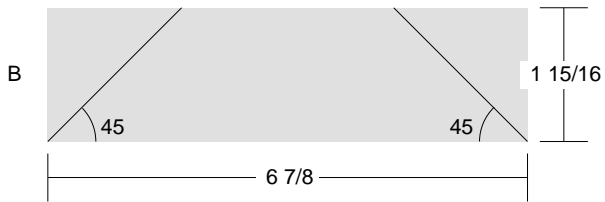

Handweave! - jbw VcW

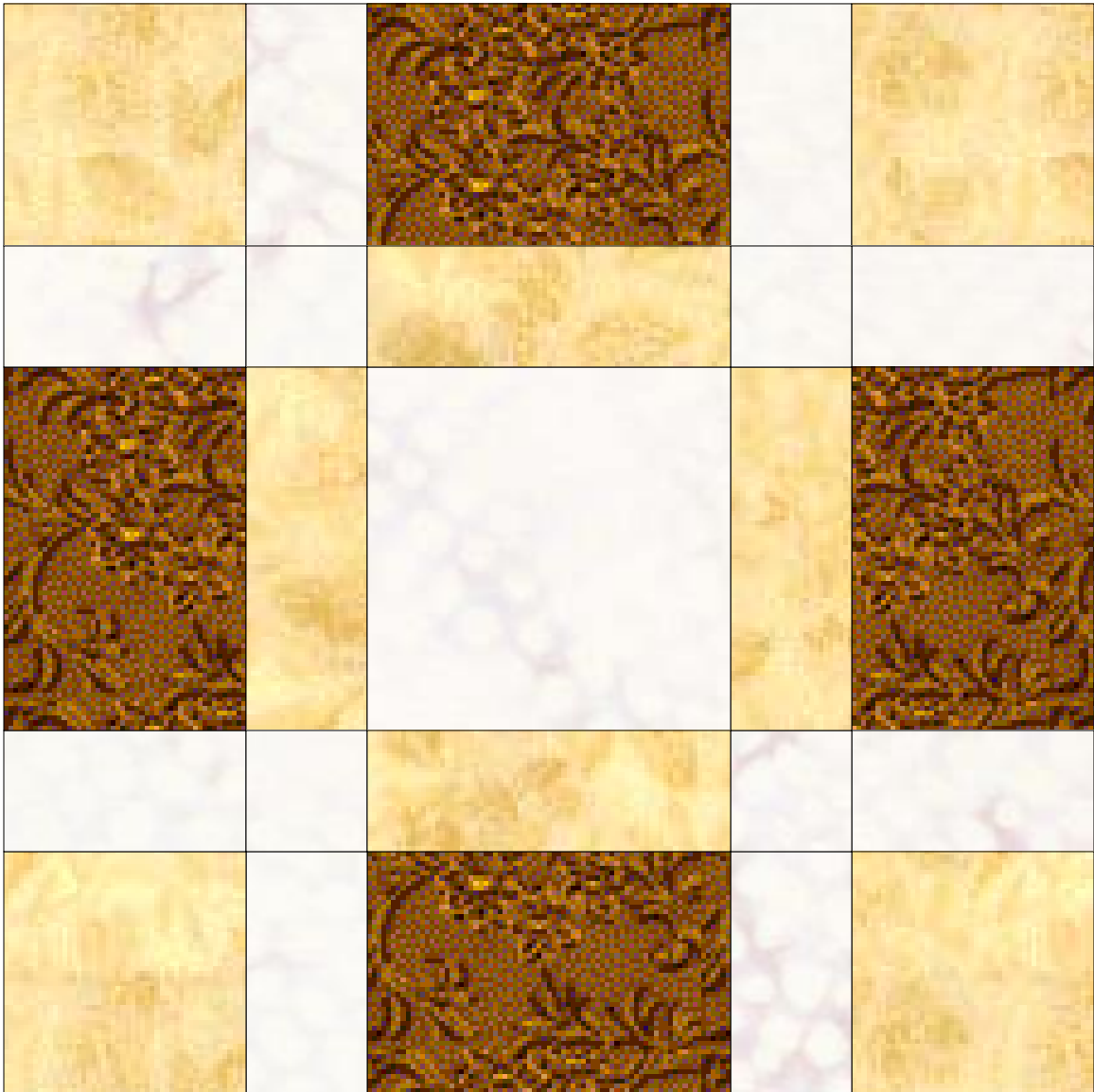

Handweave

Key Block (19/50 actual size)

A	B	C	B	A
B	D	E	D	B
C	E	F	E	C
B	D	E	D	B
A	B	C	B	A

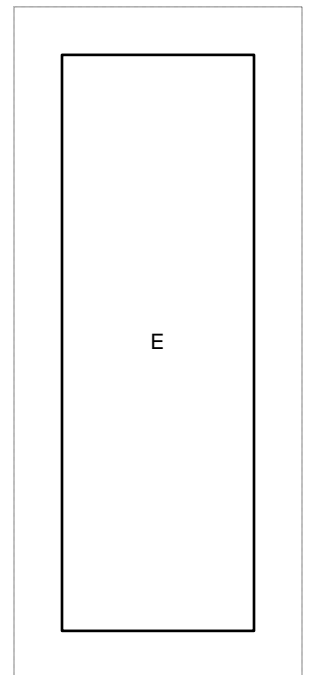
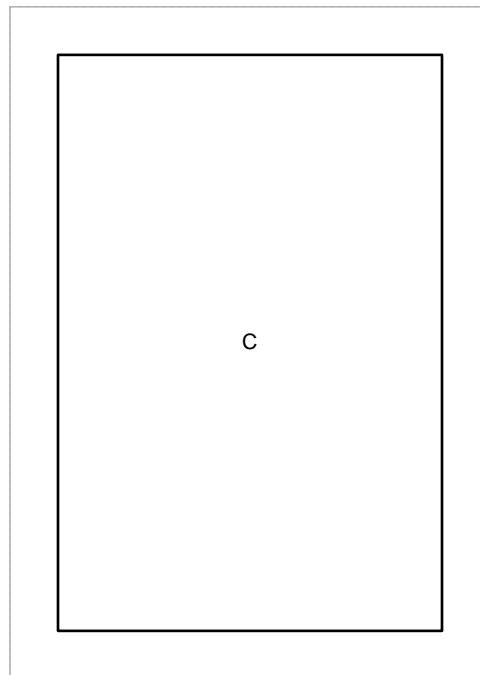
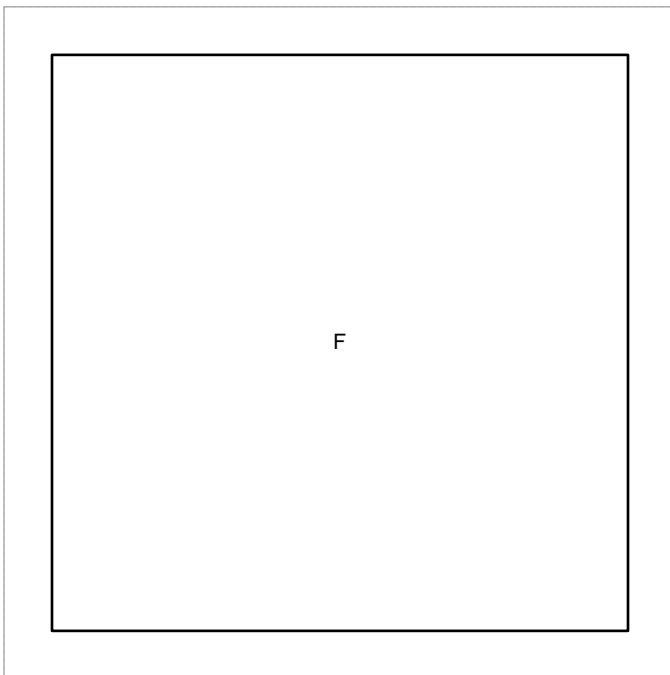

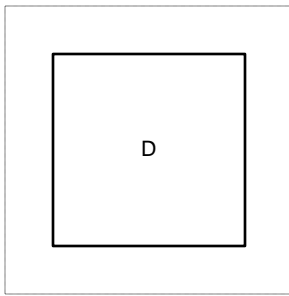
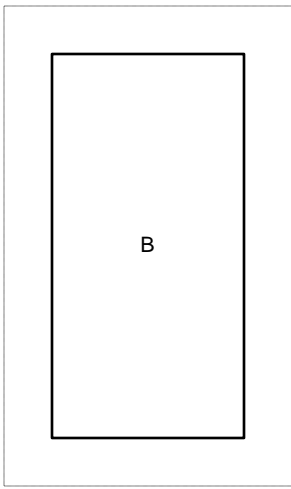
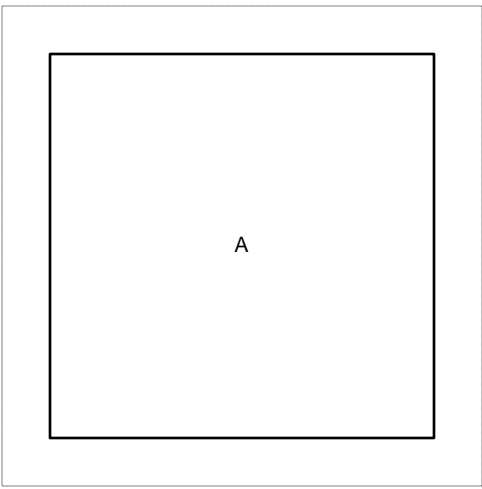

Handweave

Key Block (27/100 actual size)

A	B	C	B	A
B	D	E	D	B
C	E	F	E	C
B	D	E	D	B
A	B	C	B	A

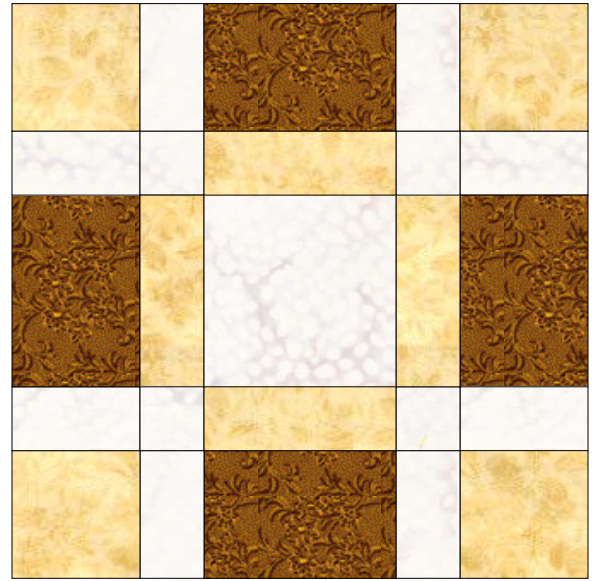

Cutting Diagrams

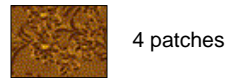
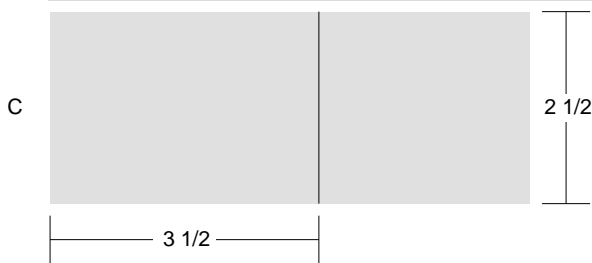
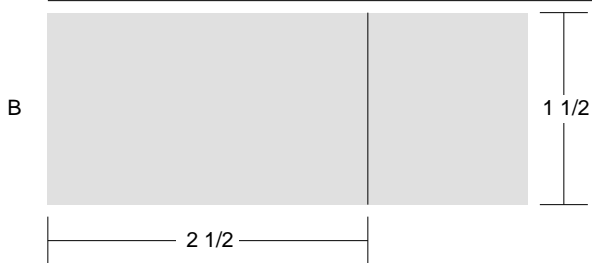
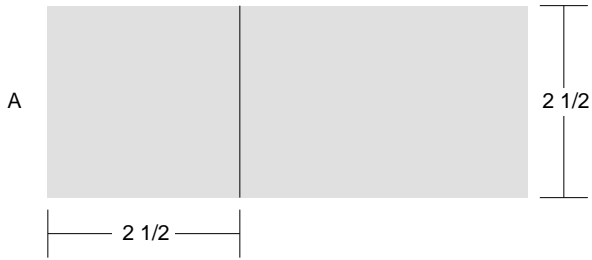

Patch Count

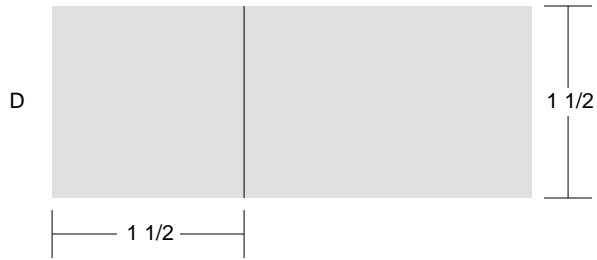

4 patches

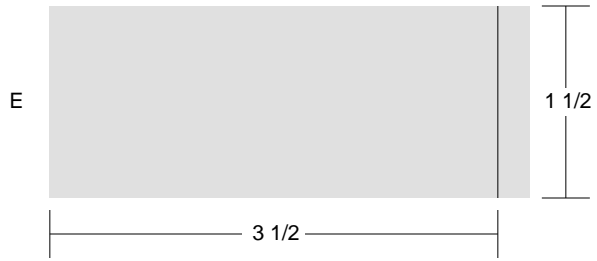

4 patches



1 patch

Linking Blocks!

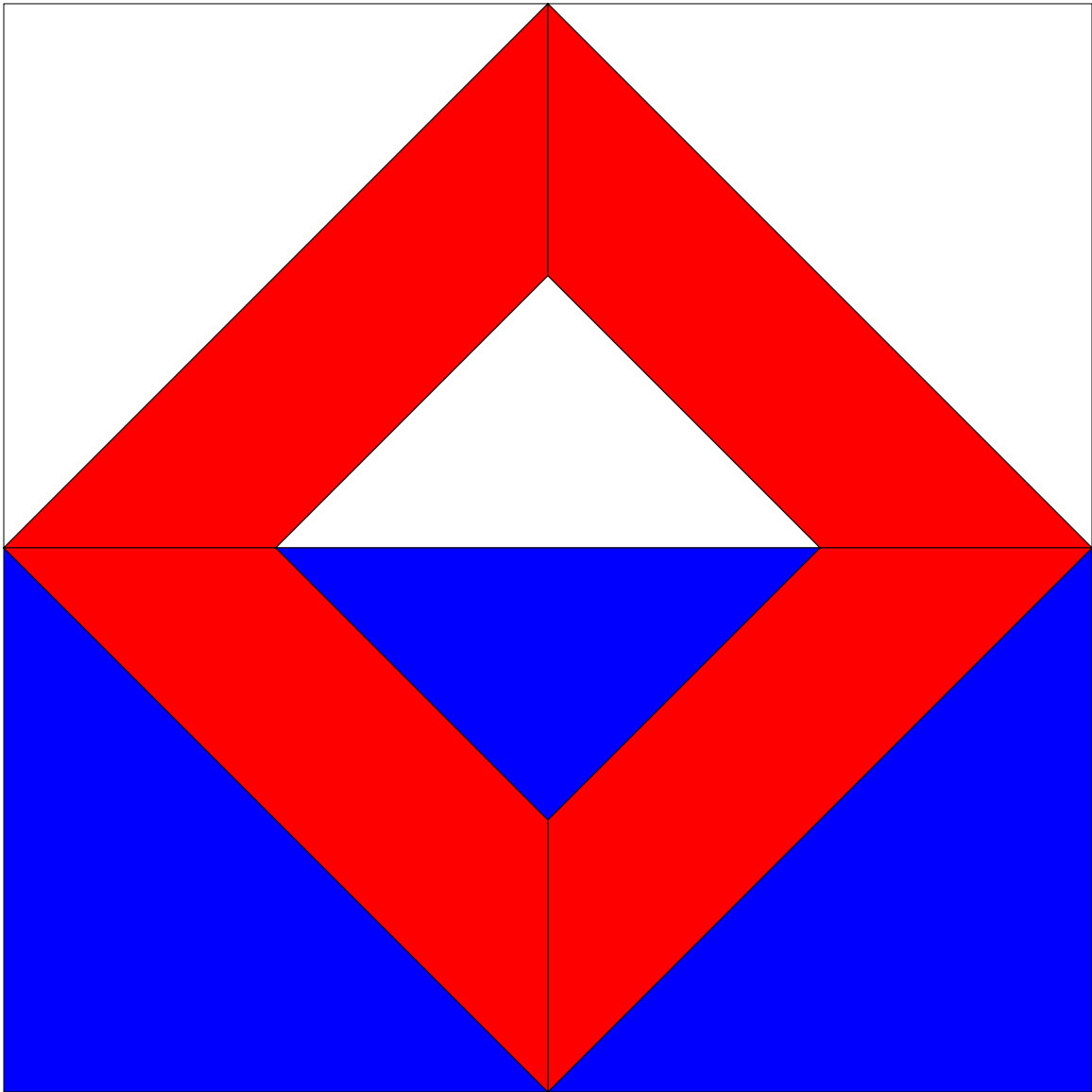

Linking Blocks

Key Block (43/100 actual size)

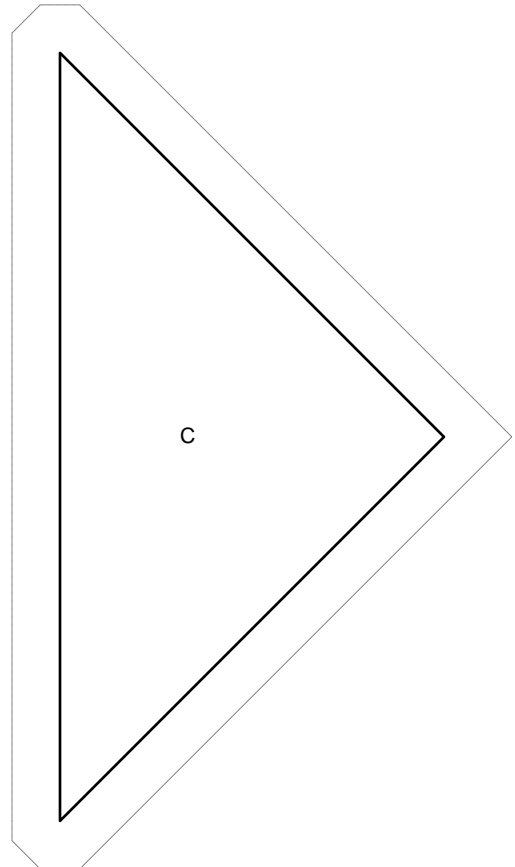
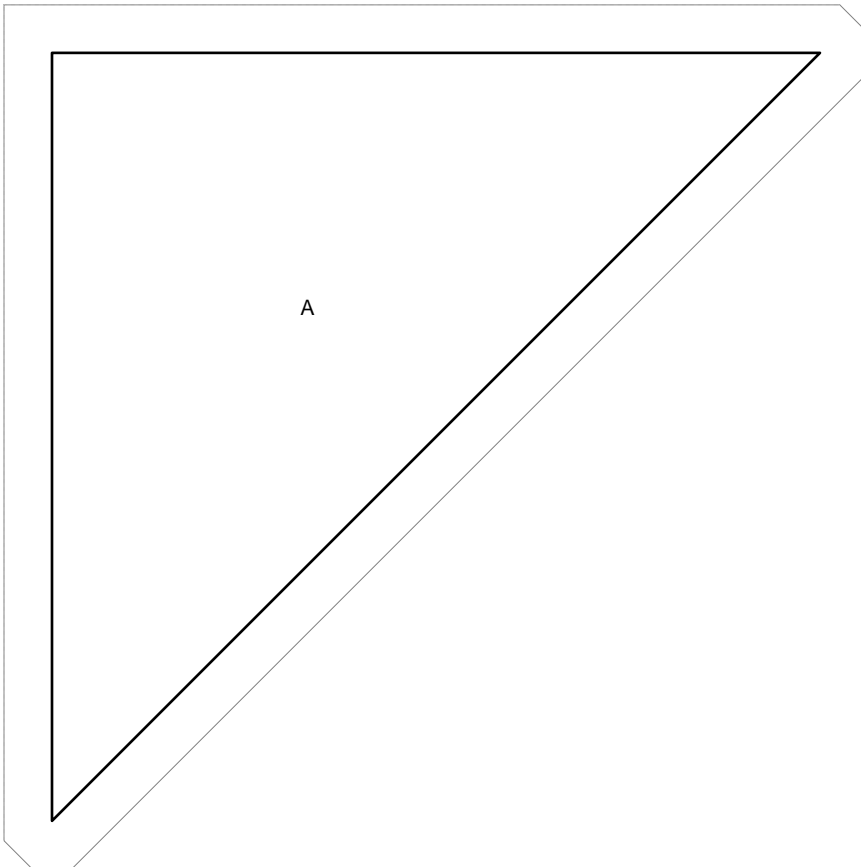
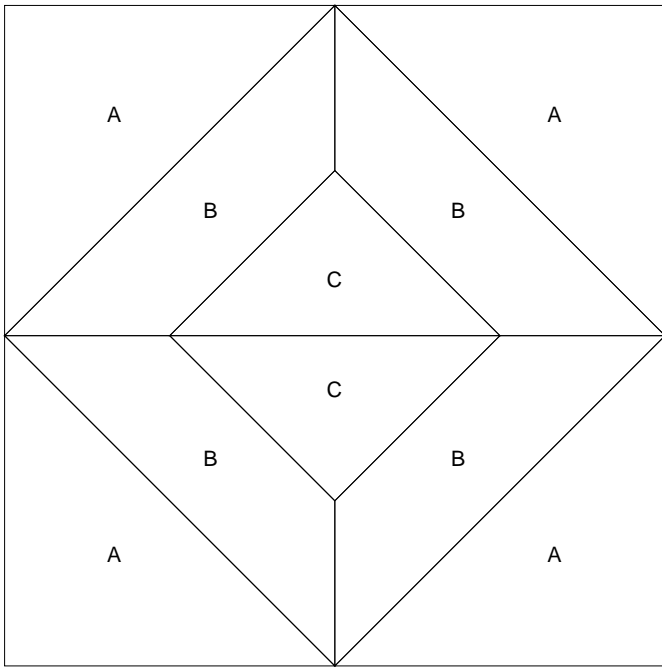

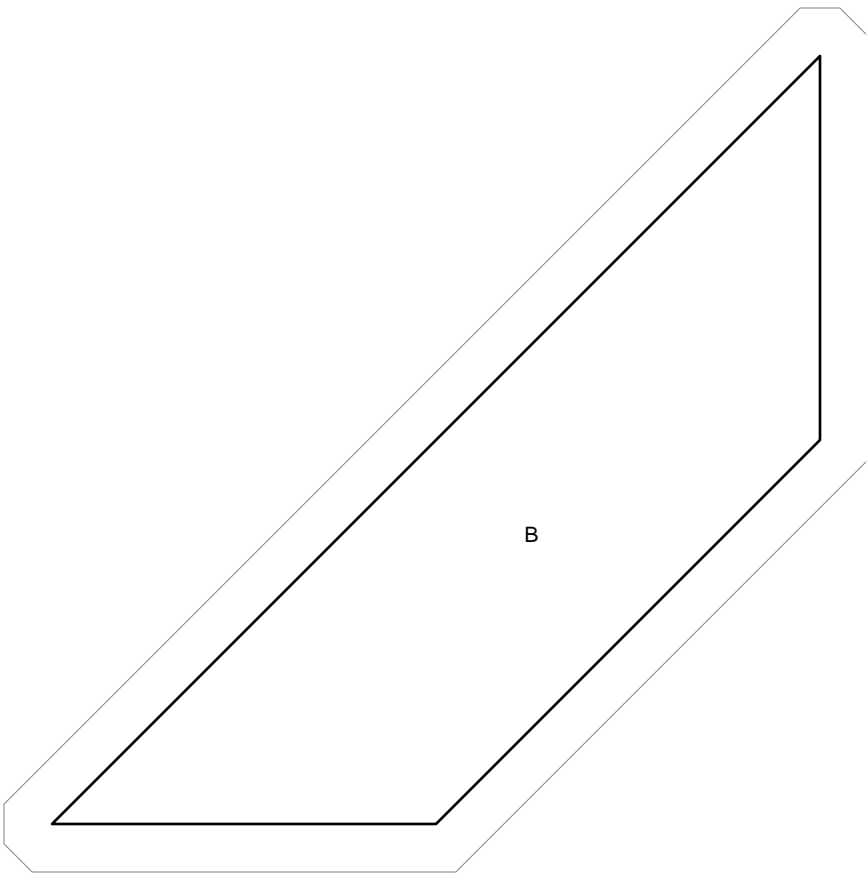

Linking Blocks

Key Block (31/100 actual size)

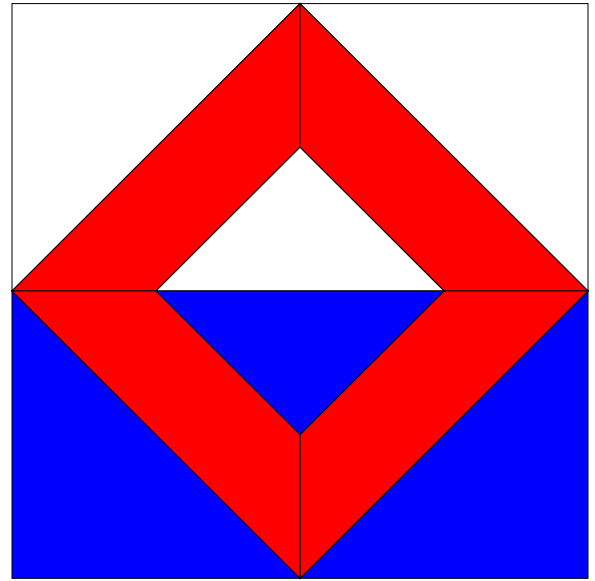
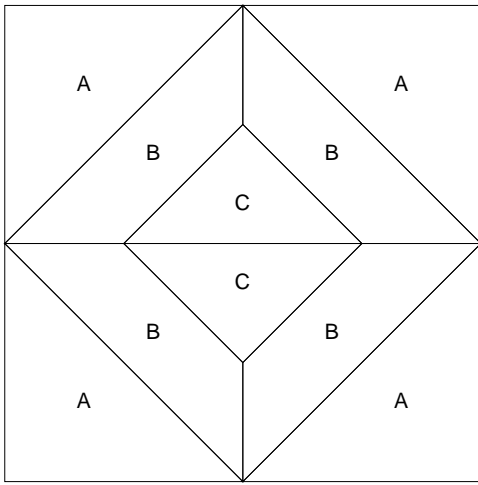

Cutting Diagrams

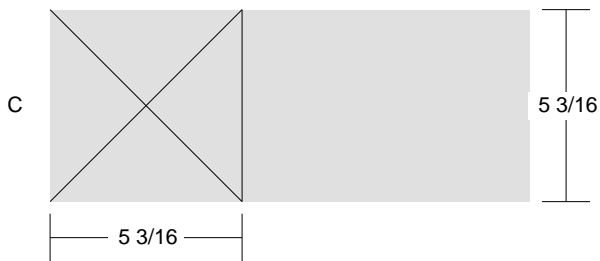
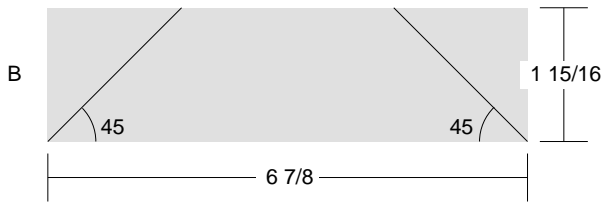
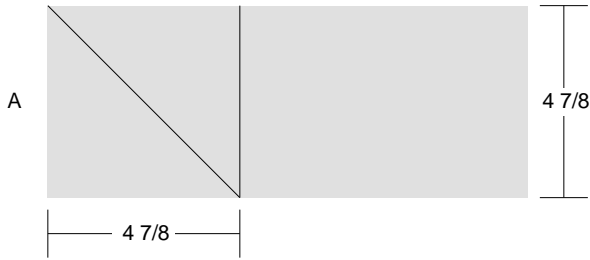

Red, White, and Blue - 9 inch block

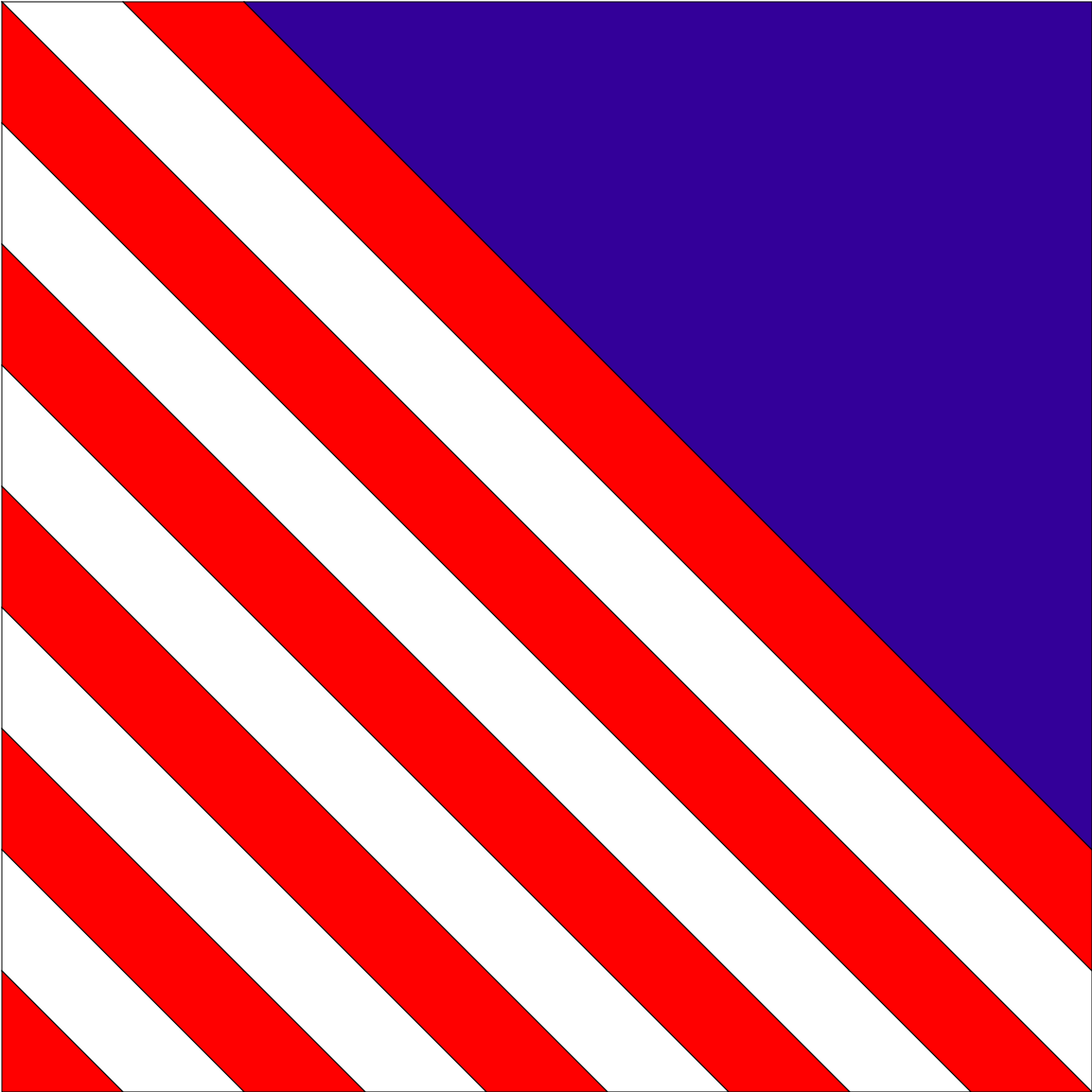

Red, White, and Blue

Key Block (19/50 actual size)

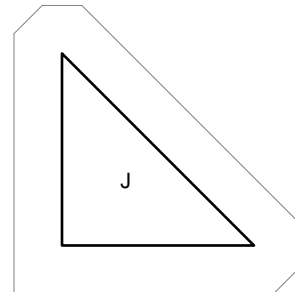
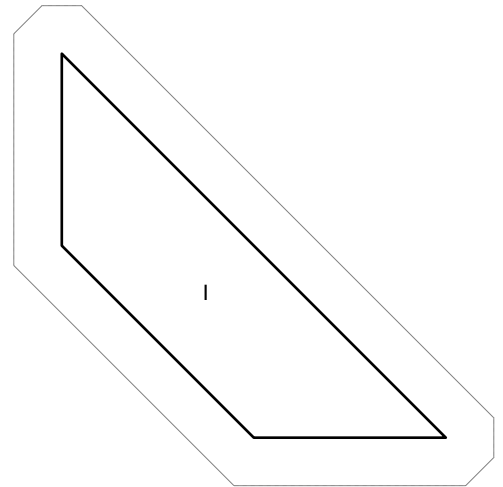
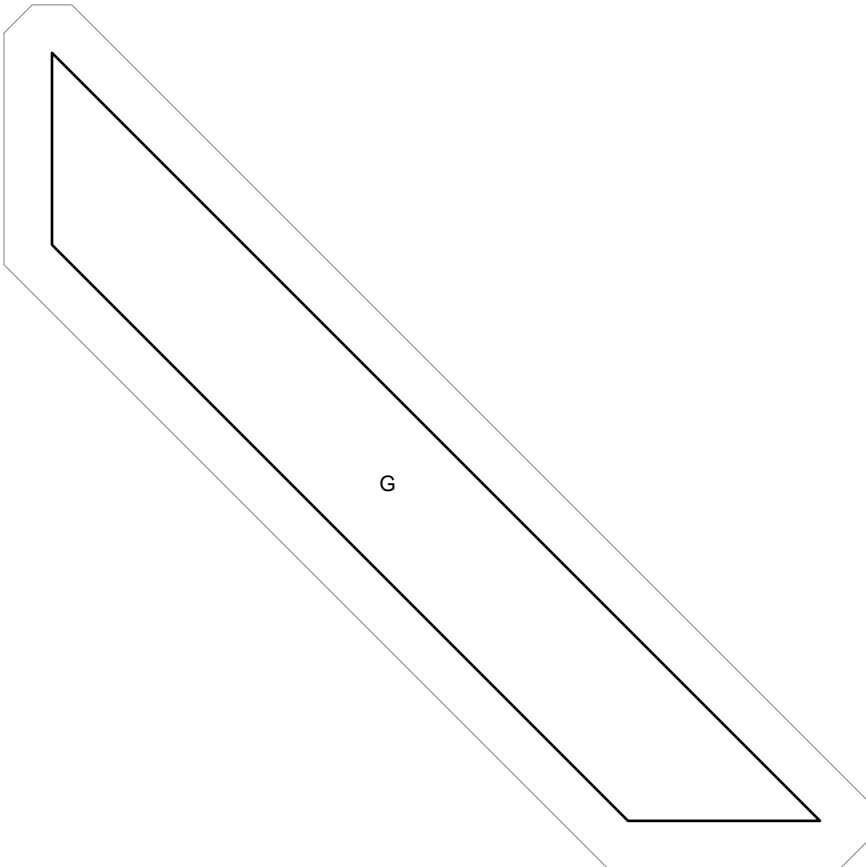
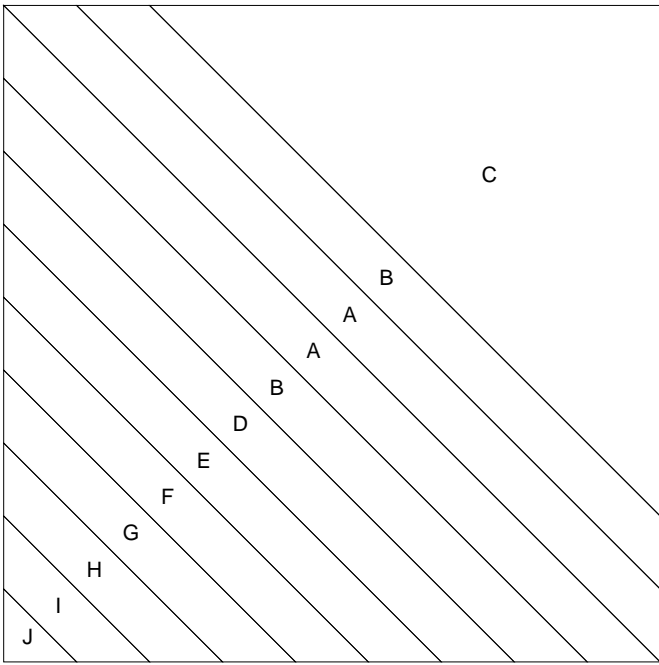

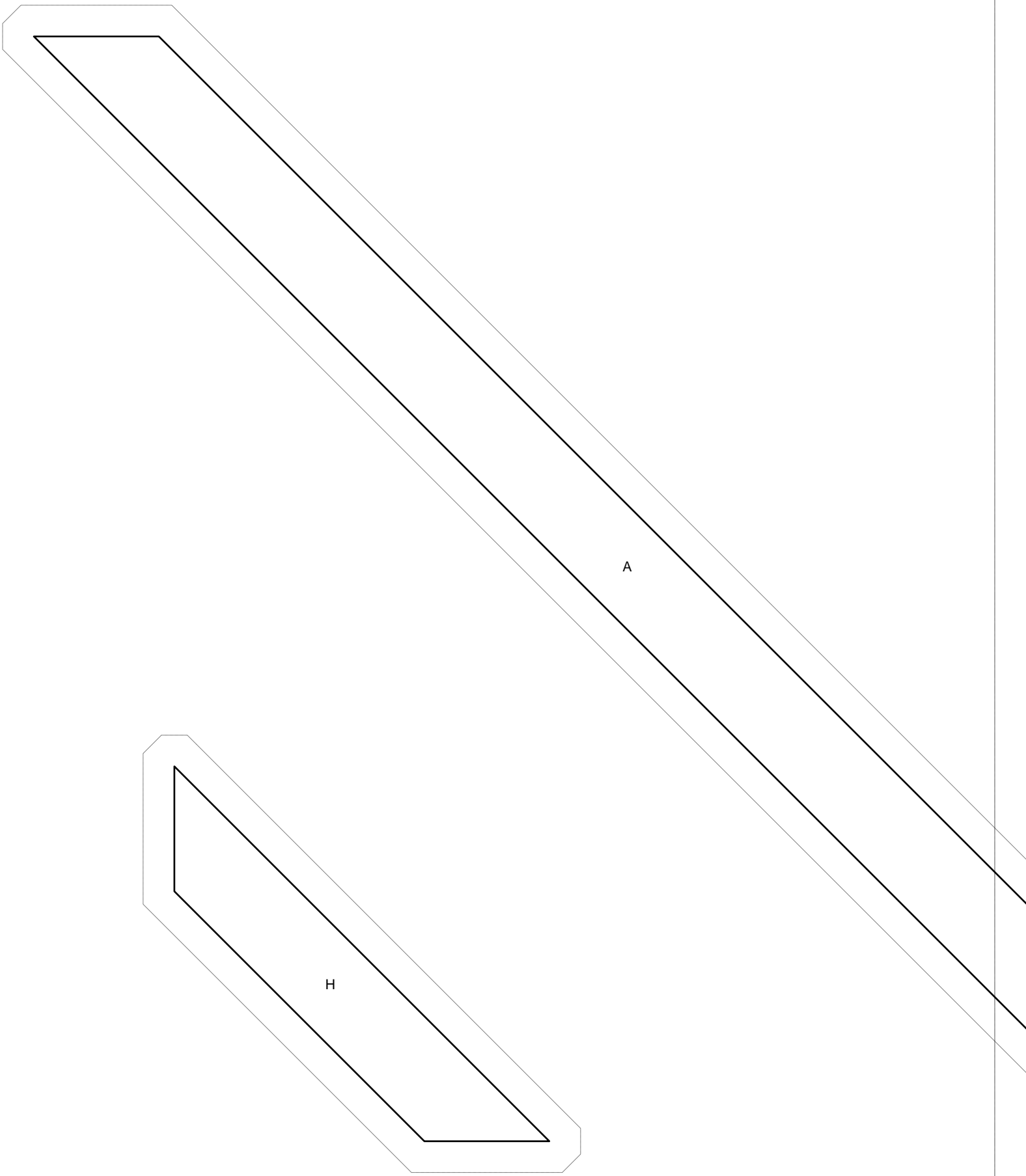

A

H

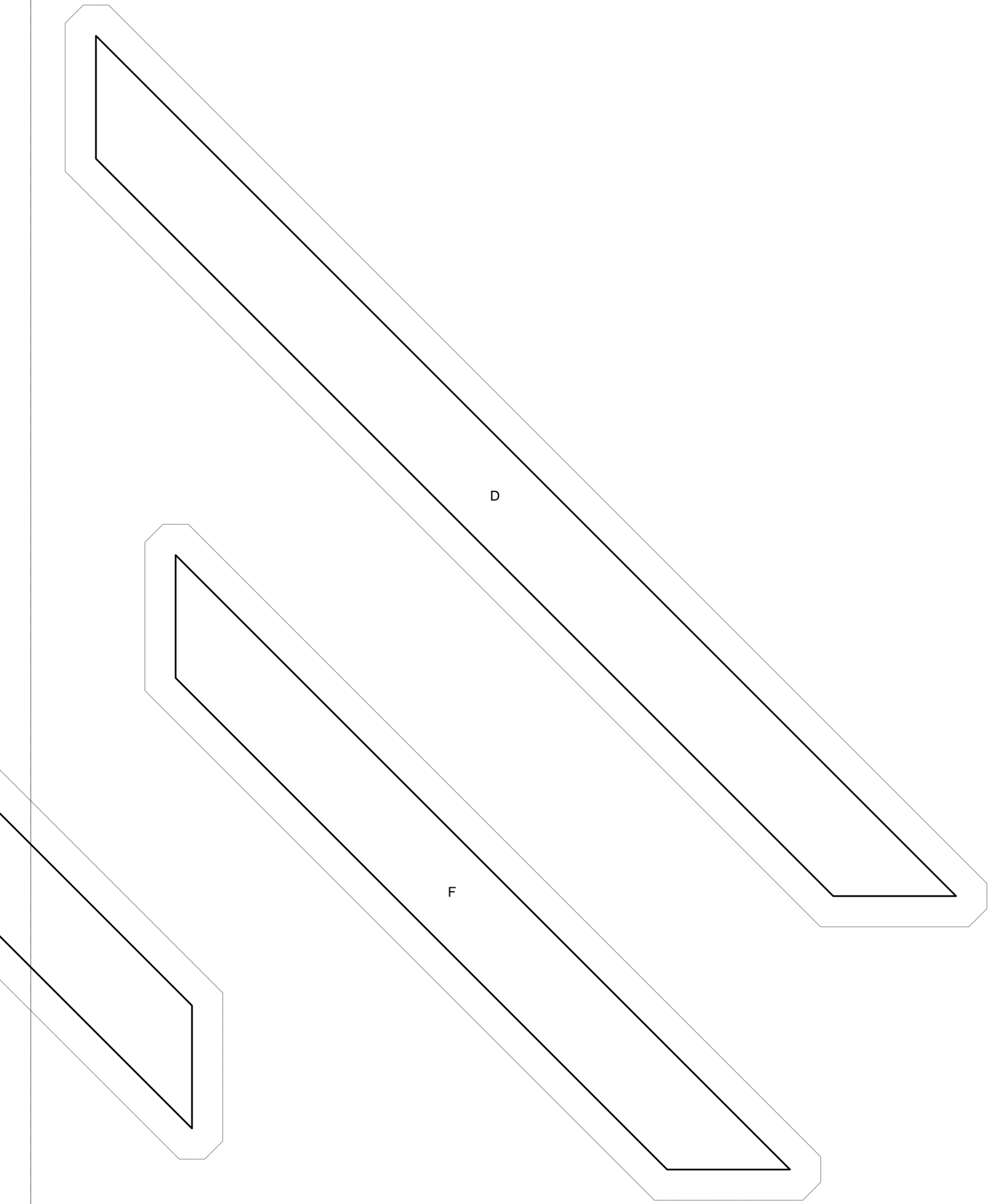

D

F

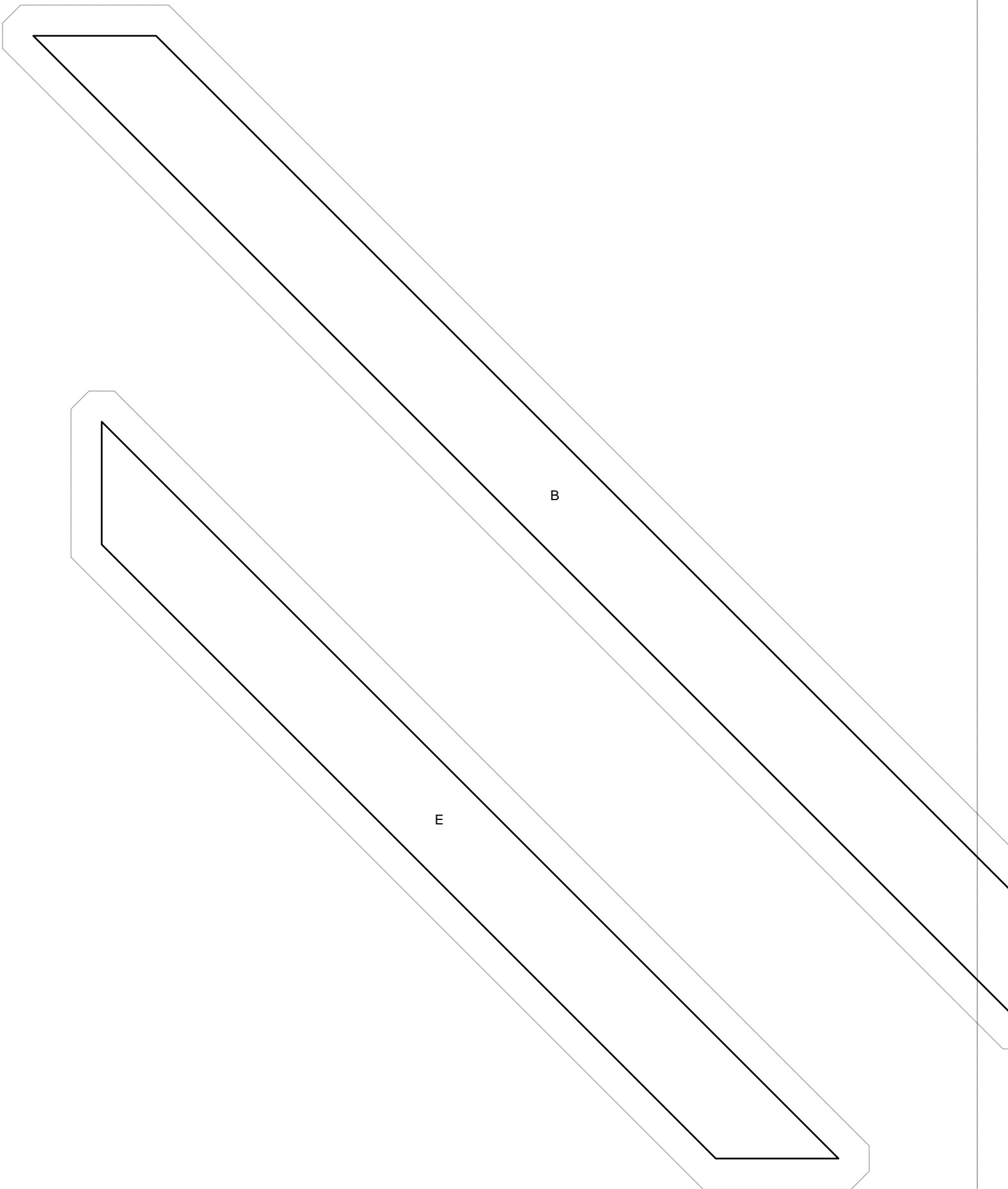

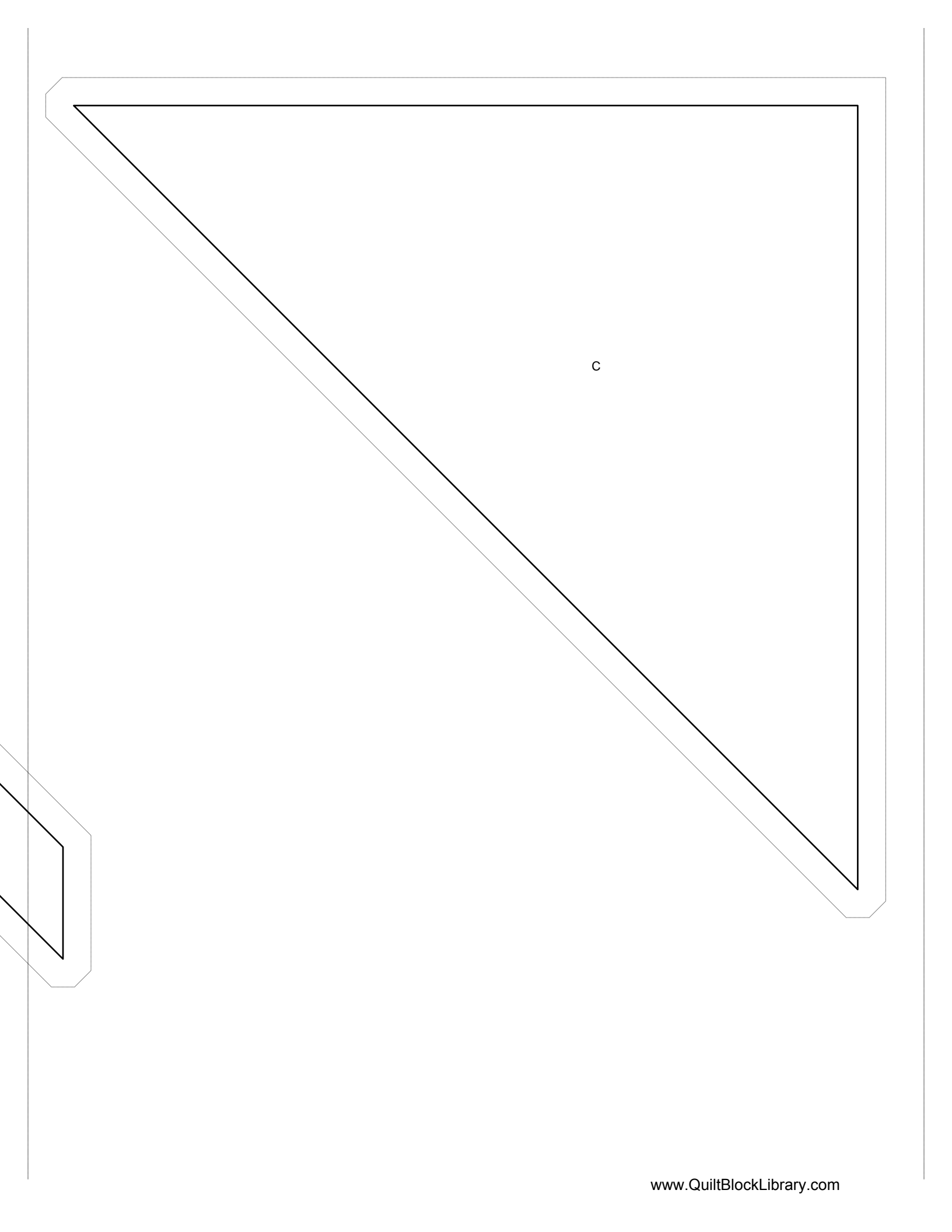

c

Red, White, and Blue

Key Block (27/100 actual size)

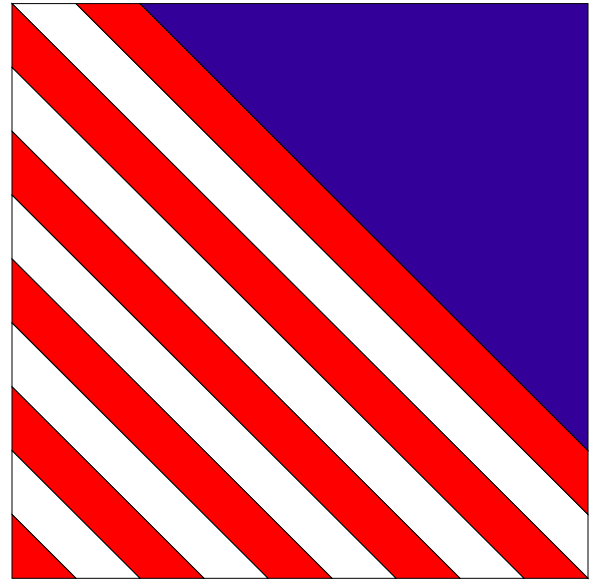
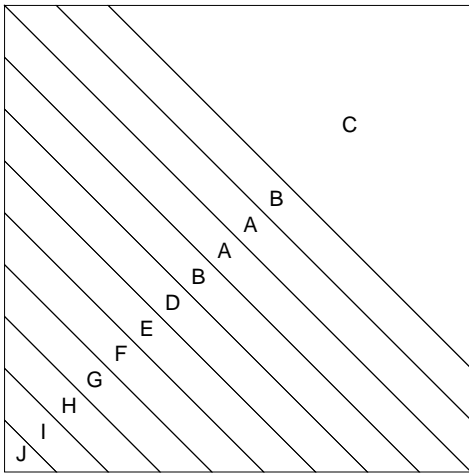

Cutting Diagrams

Patch Count

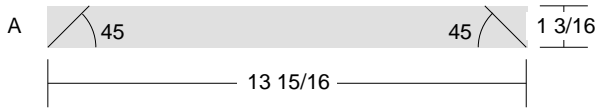

1 patch



1 patch

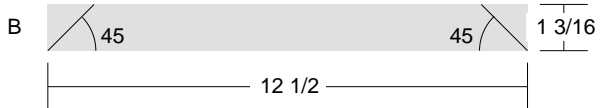

1 patch



1 patch

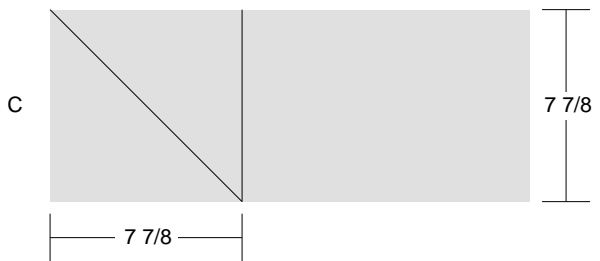

1 patch

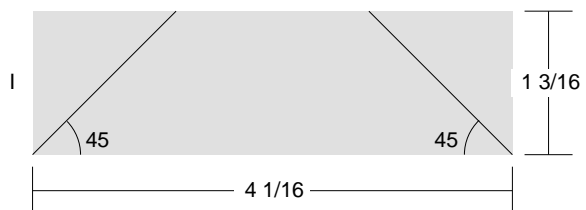
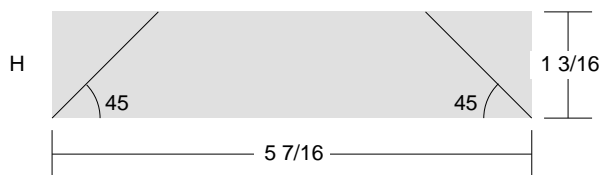
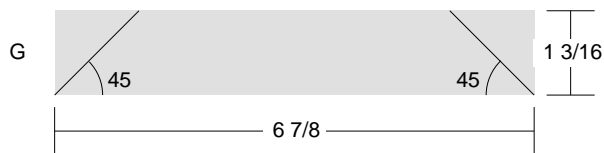
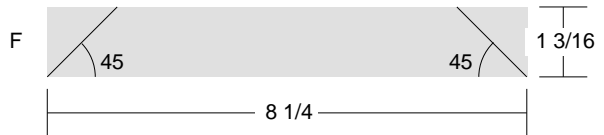
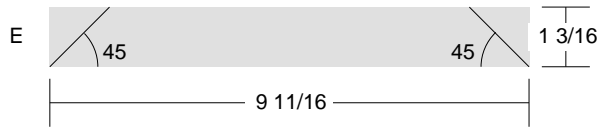
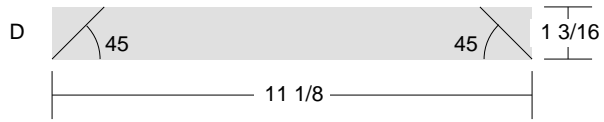

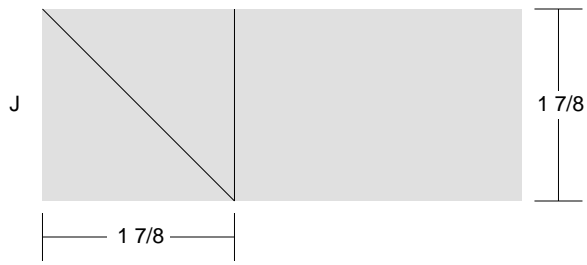

1 patch

Shooting Squares!

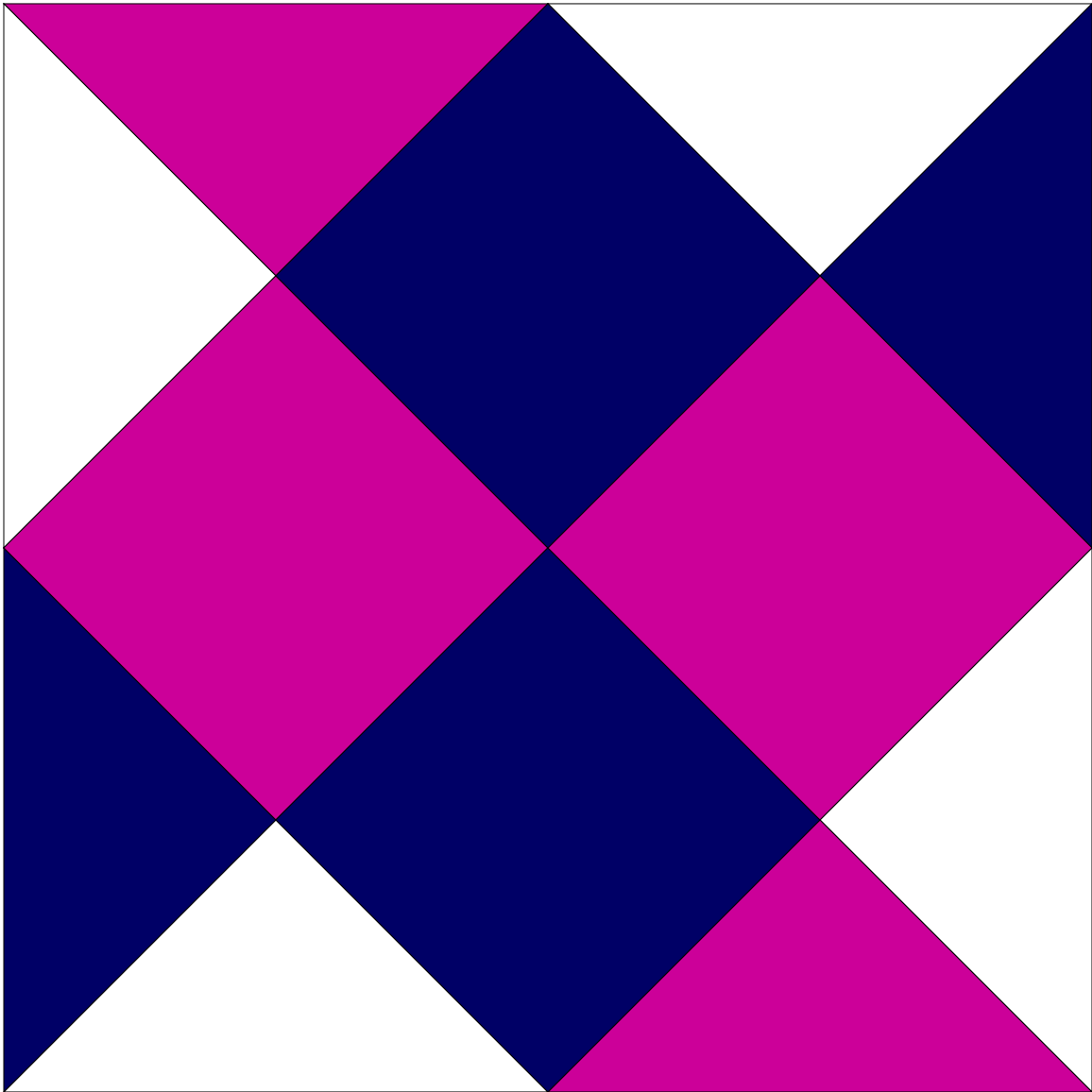

Shooting Squares

Key Block (43/100 actual size)

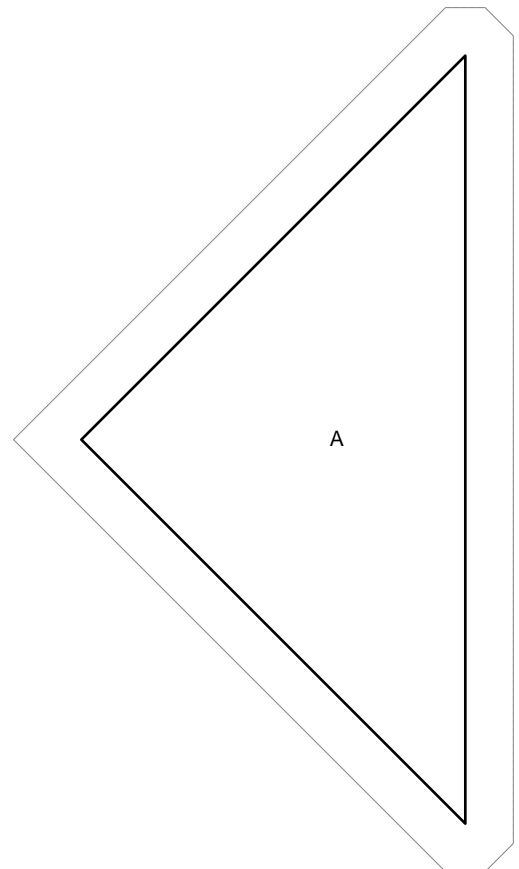
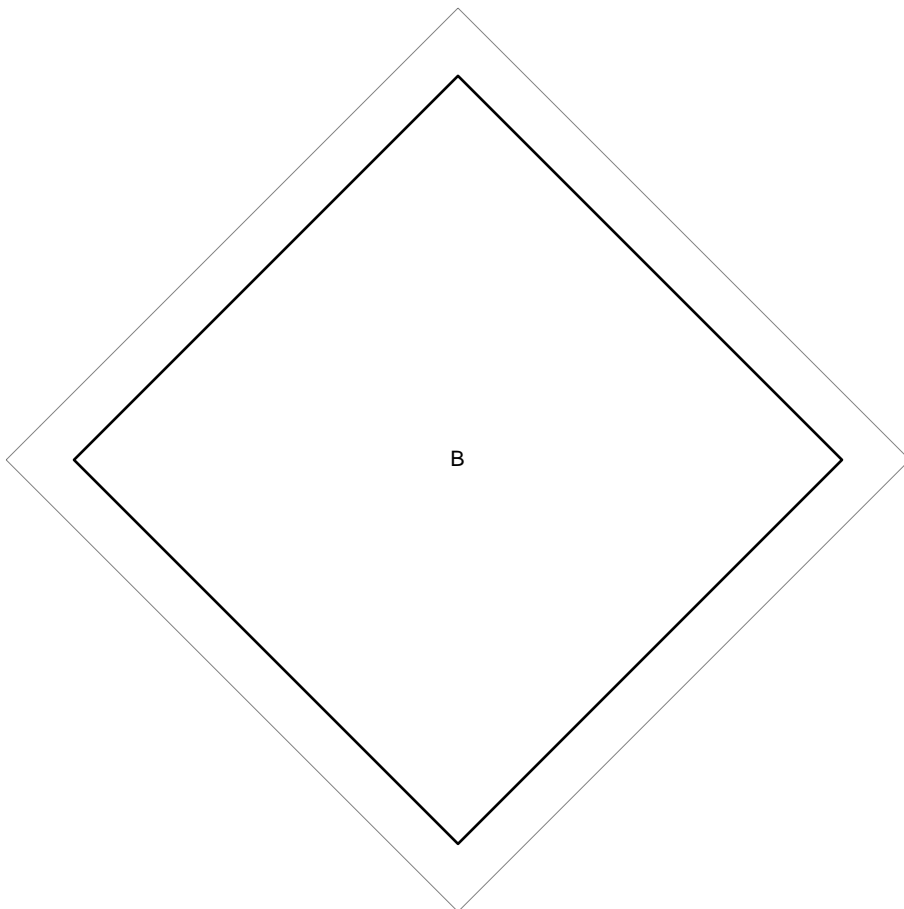
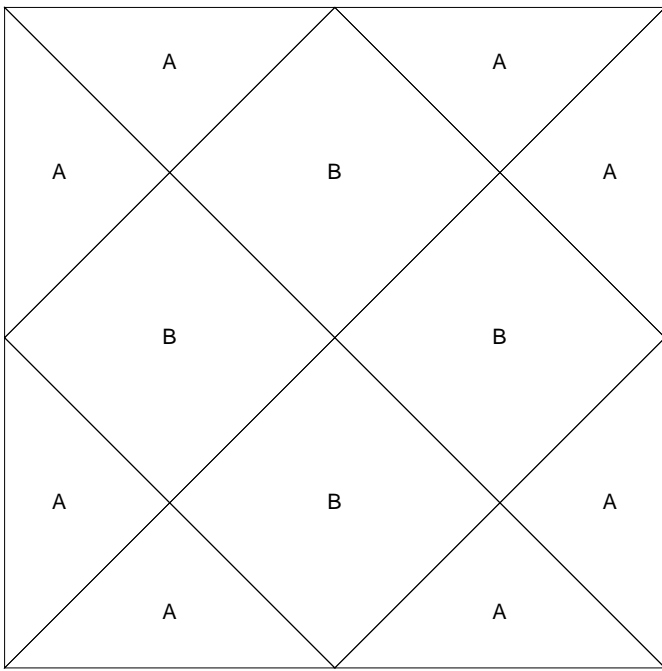

Shooting Squares

Key Block (31/100 actual size)

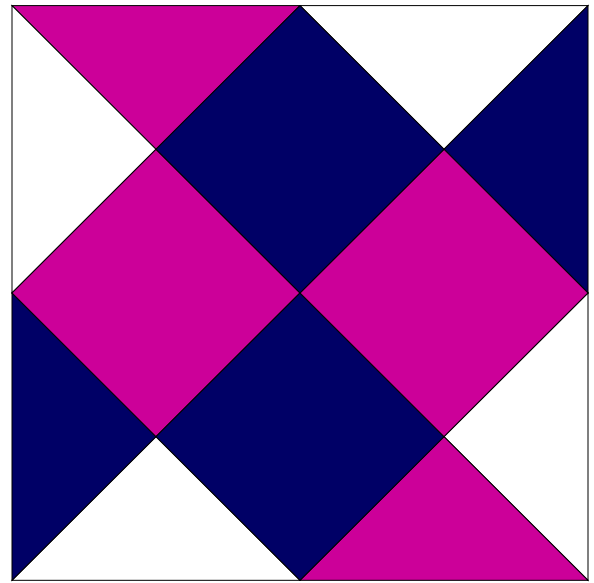
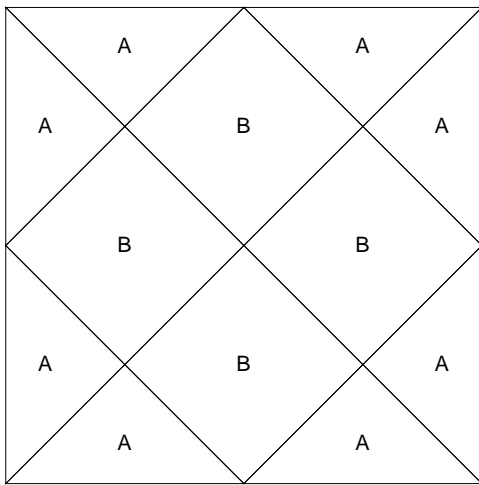

Cutting Diagrams

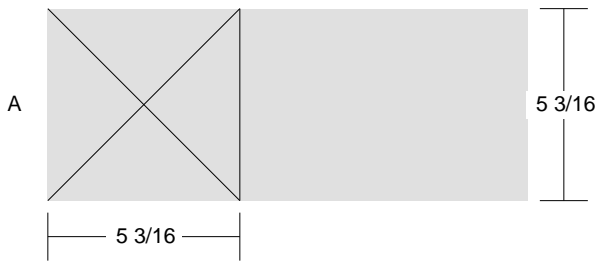

Patch Count

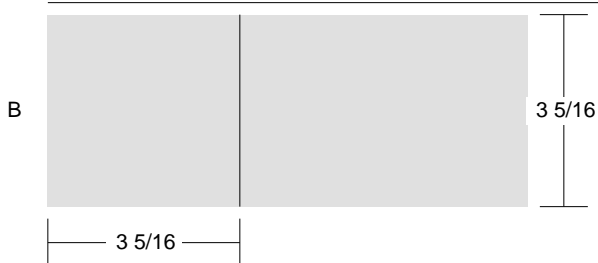

Star Diamond - 12 inch block

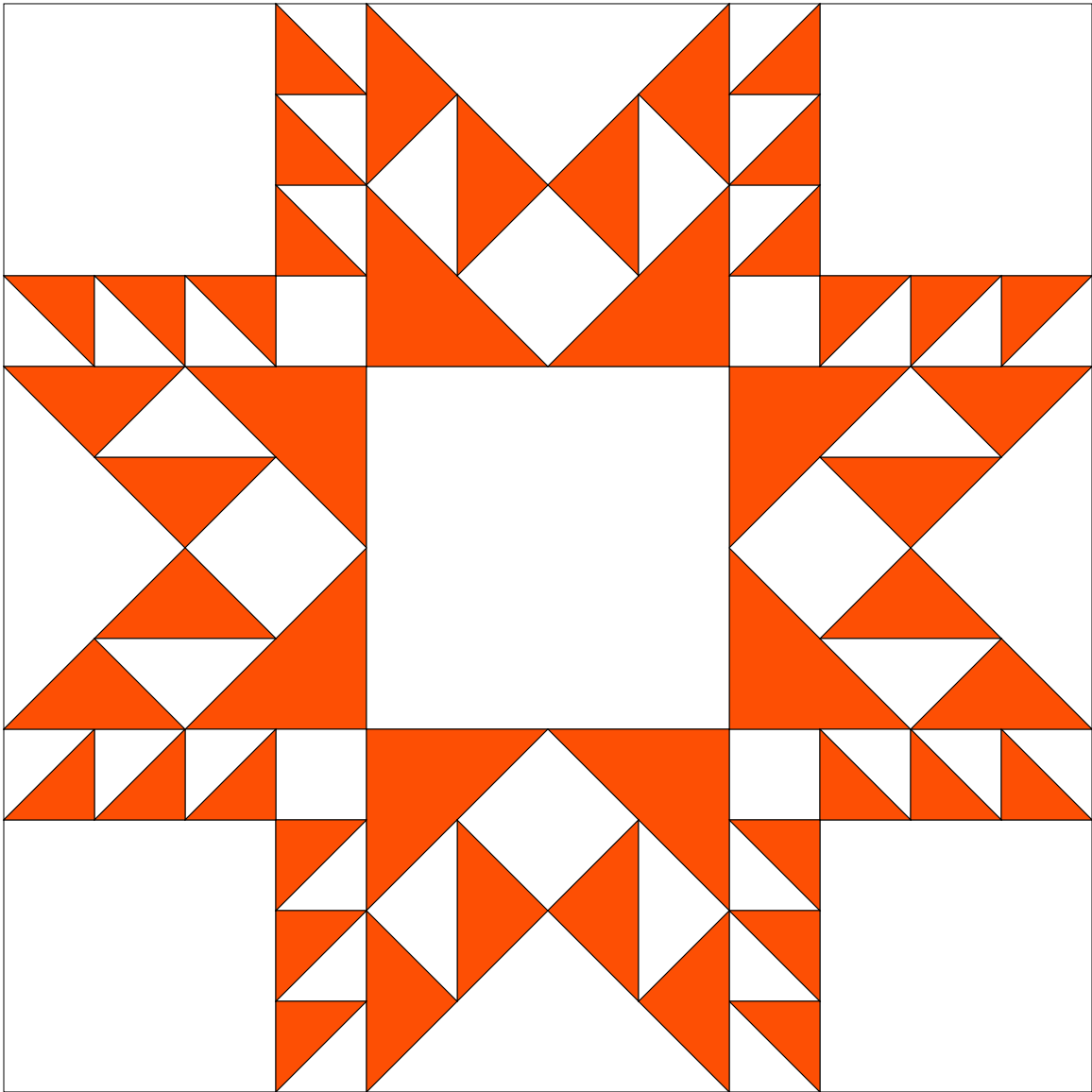

Star Diamond

Key Block (29/100 actual size)

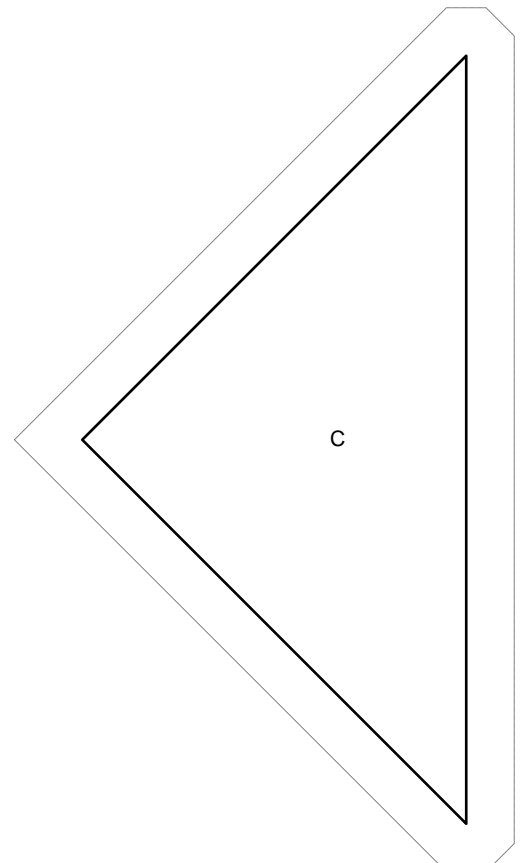
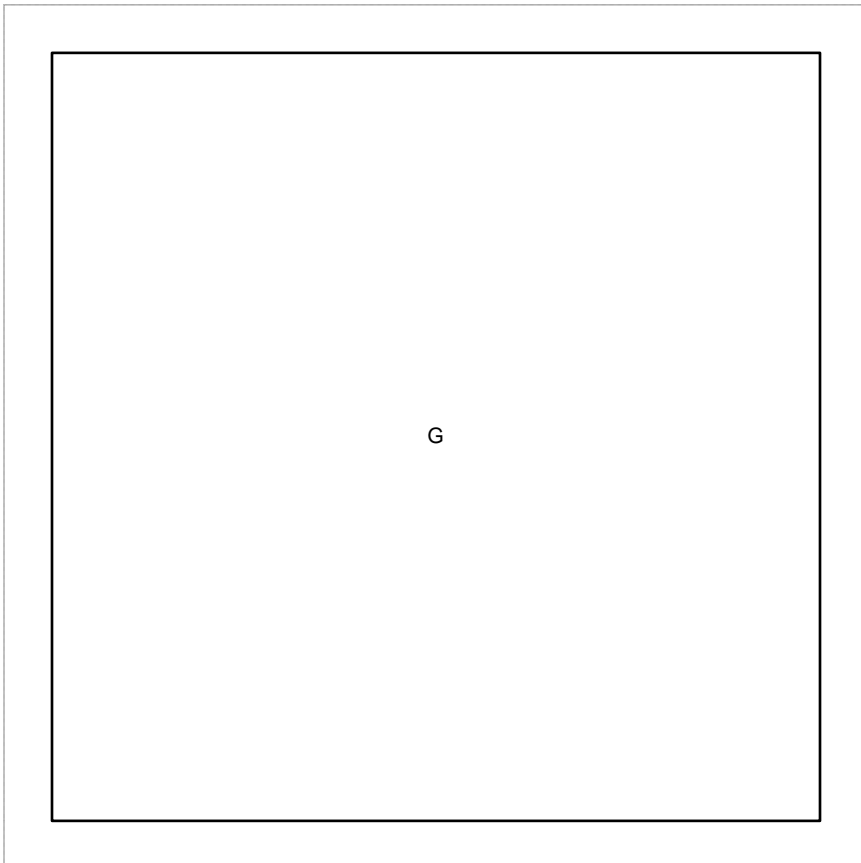
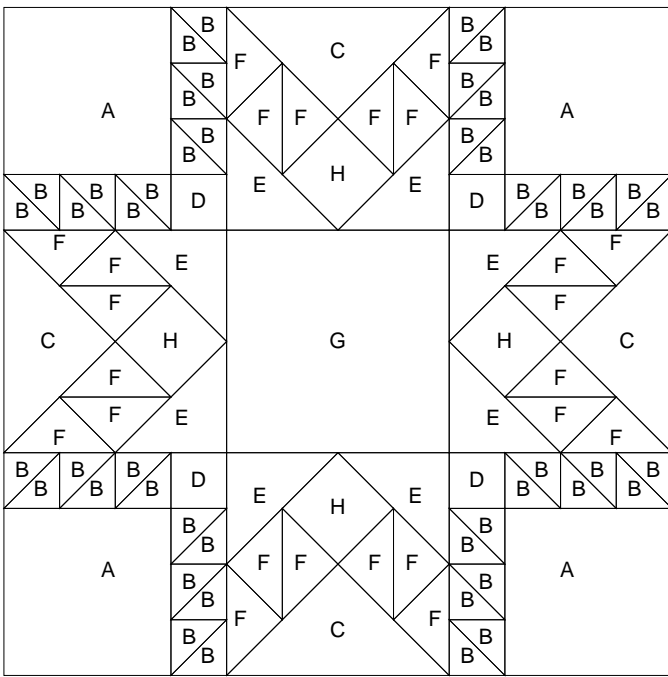

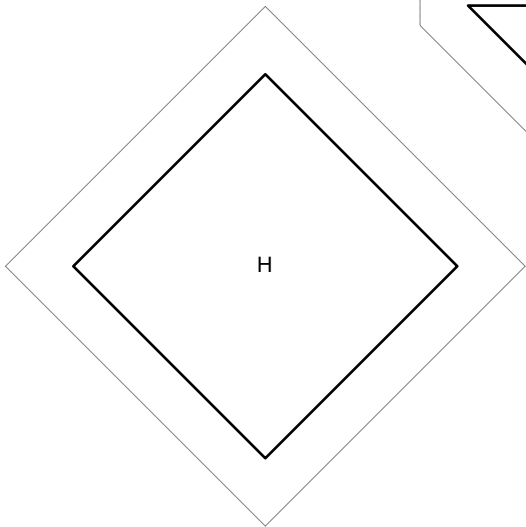
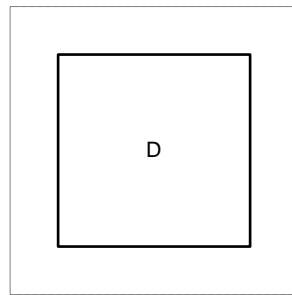
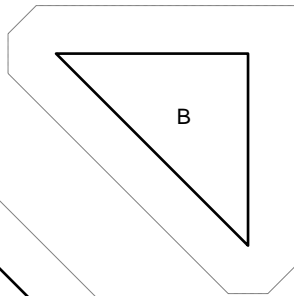
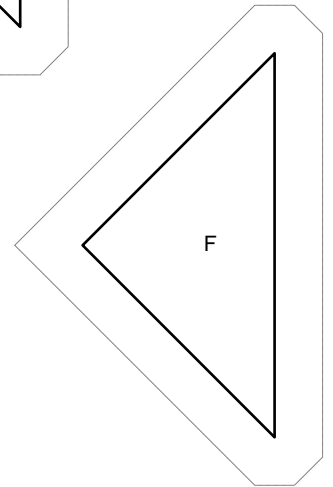
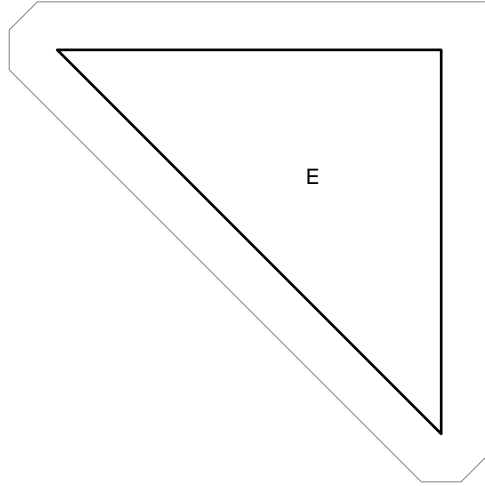
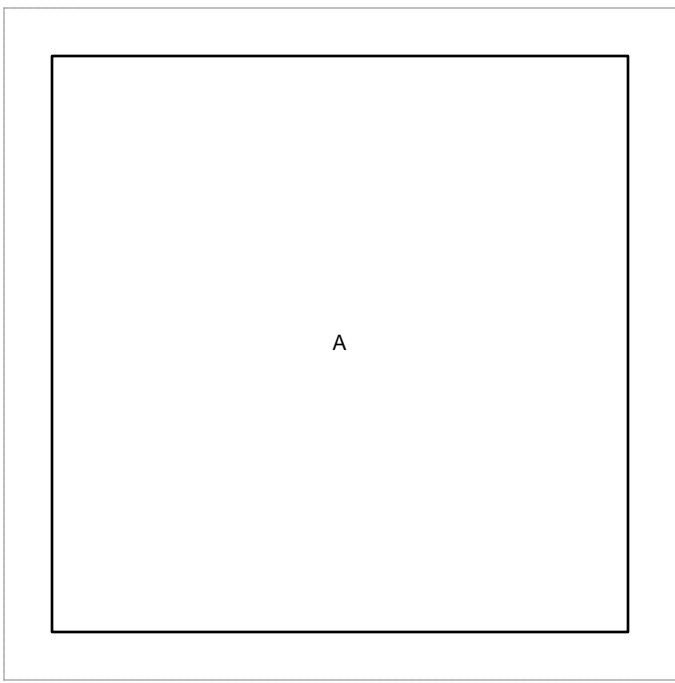

Star Diamond

Key Block (1/5 actual size)

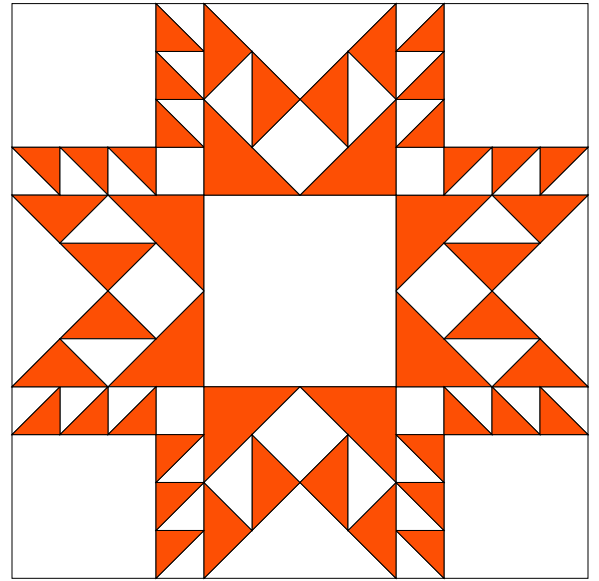
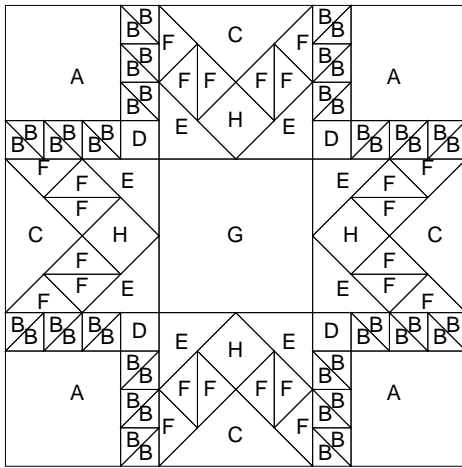

Cutting Diagrams

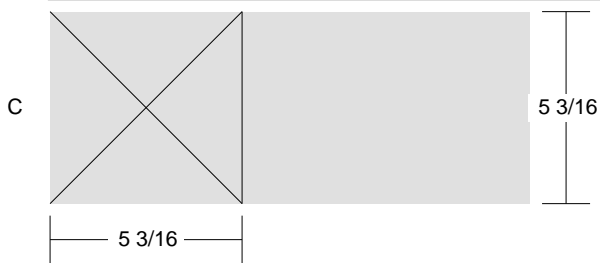
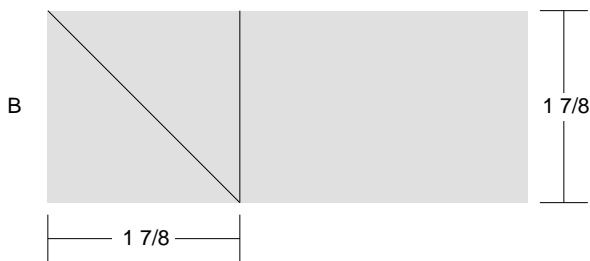
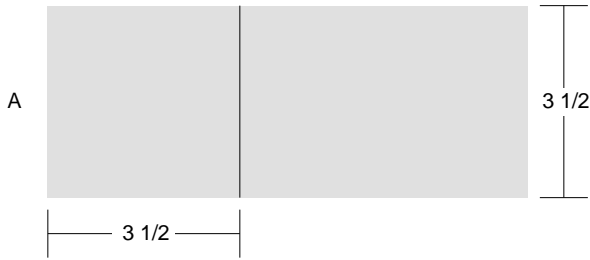

Patch Count



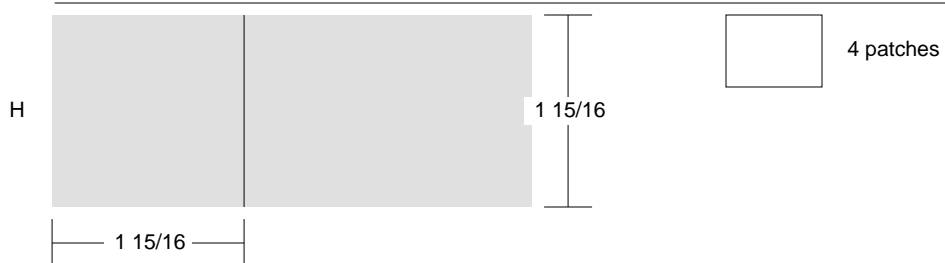
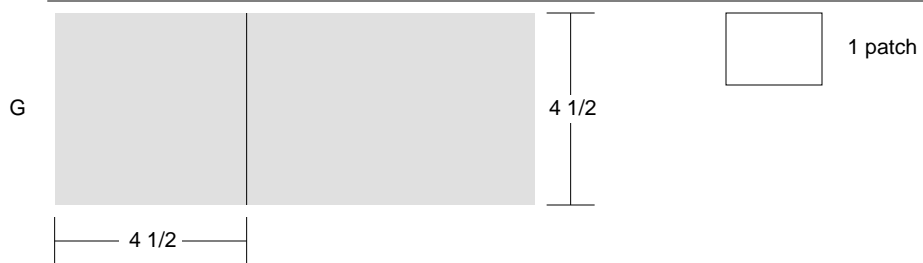
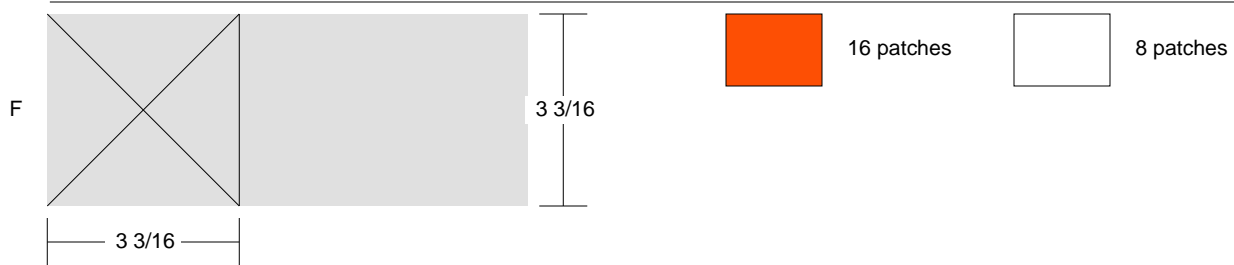
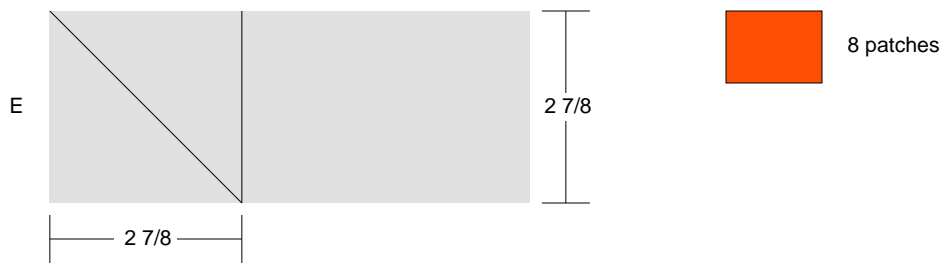
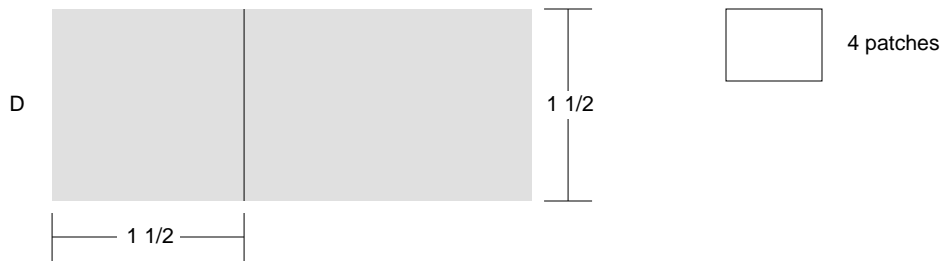

Uncle Sam's Favorite - 10 inch block

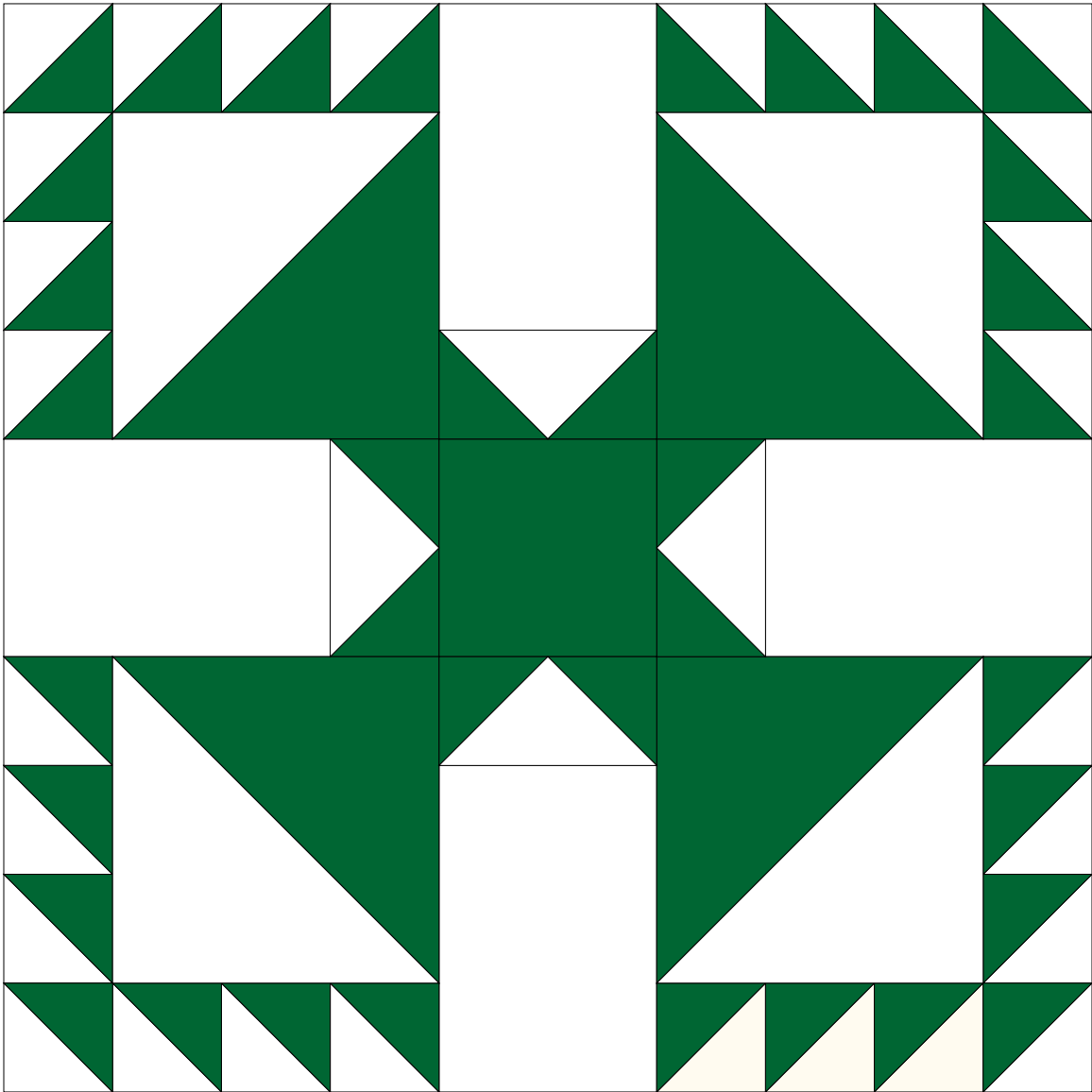

Uncle Sam's Favorite

Key Block (7/20 actual size)

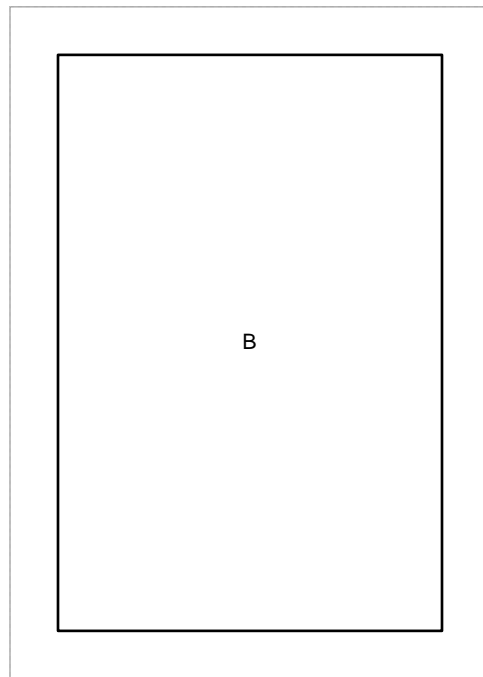
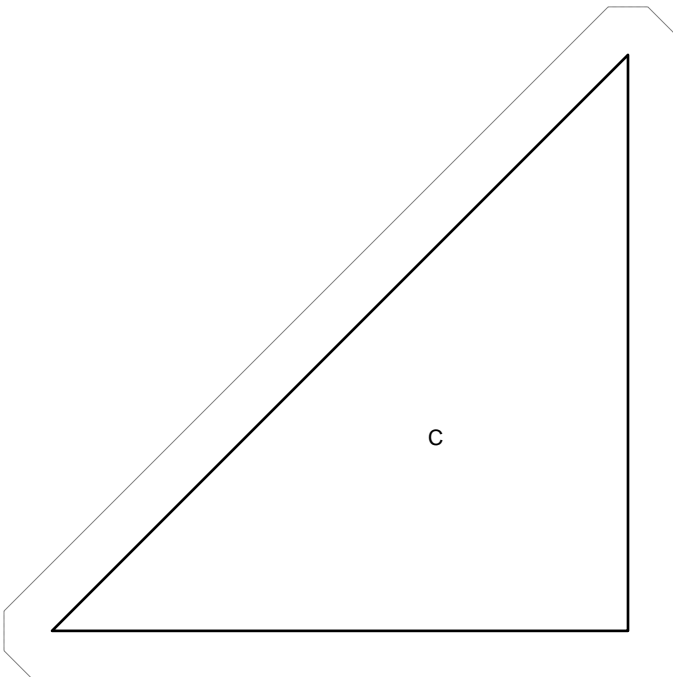
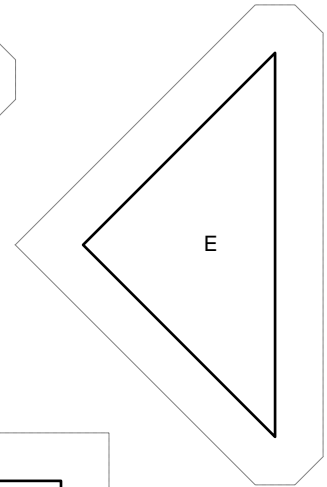
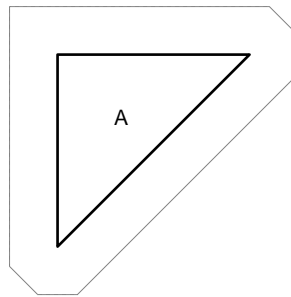
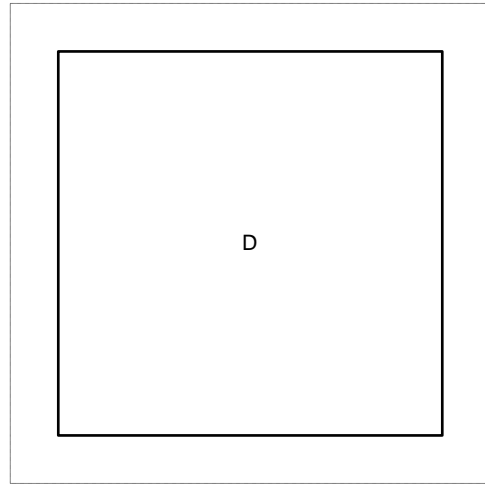
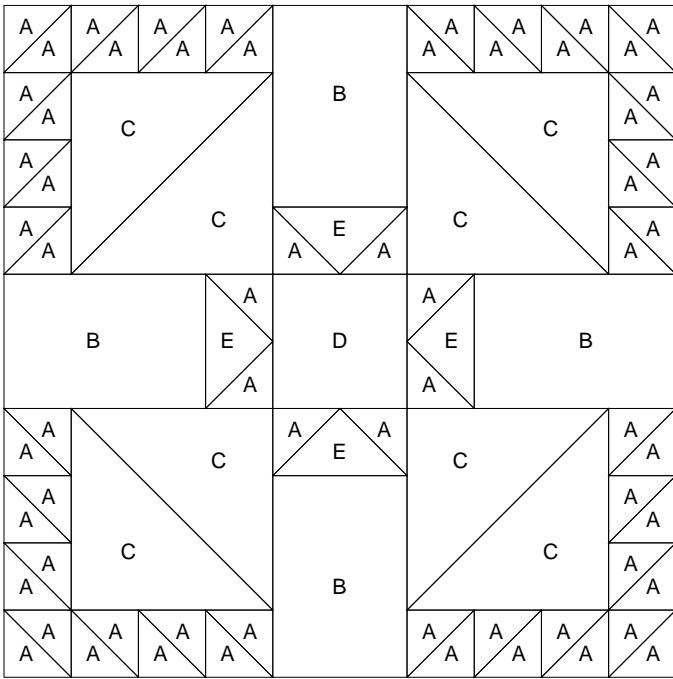

Uncle Sam's Favorite

Key Block (5/20 actual size)

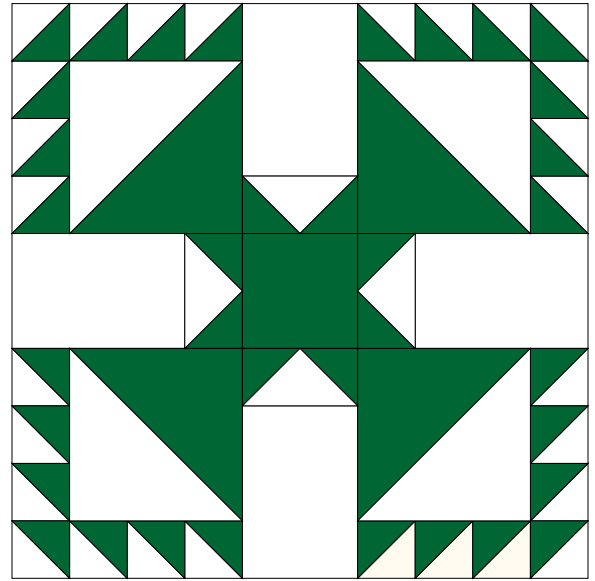
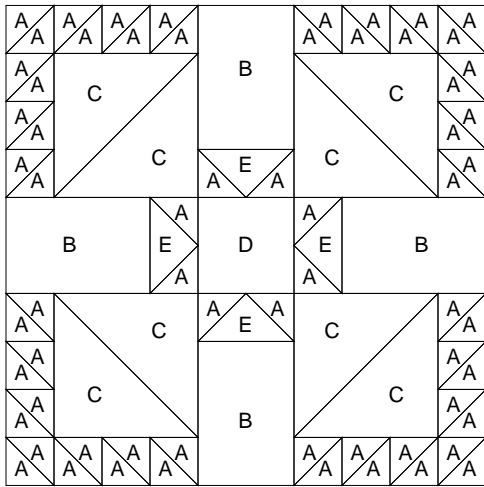

Cutting Diagrams

