

February 2010 Block Patterns

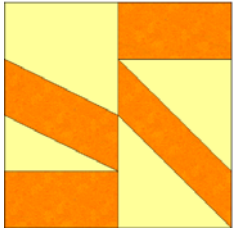

College Chain

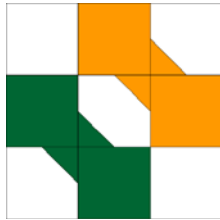

Double Necktie

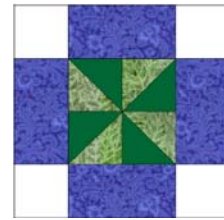

Forest Paths

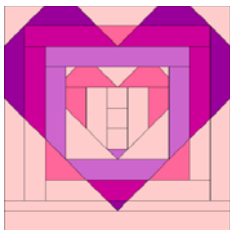

Heart Log Cabin

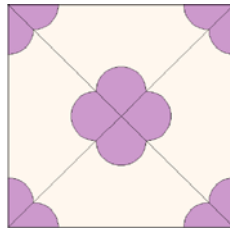

Hearts

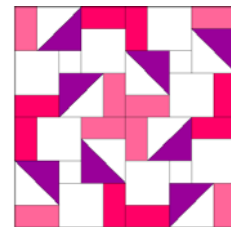

Hedgerow

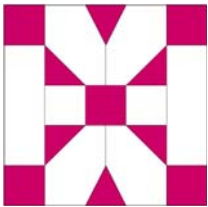

Oregon

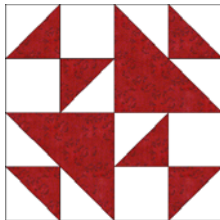

Triangle Weave

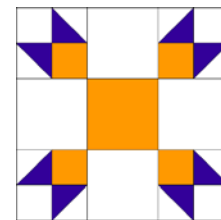

Tulip Lady
Fingers

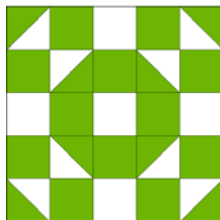

Wishing Ring

College Chain

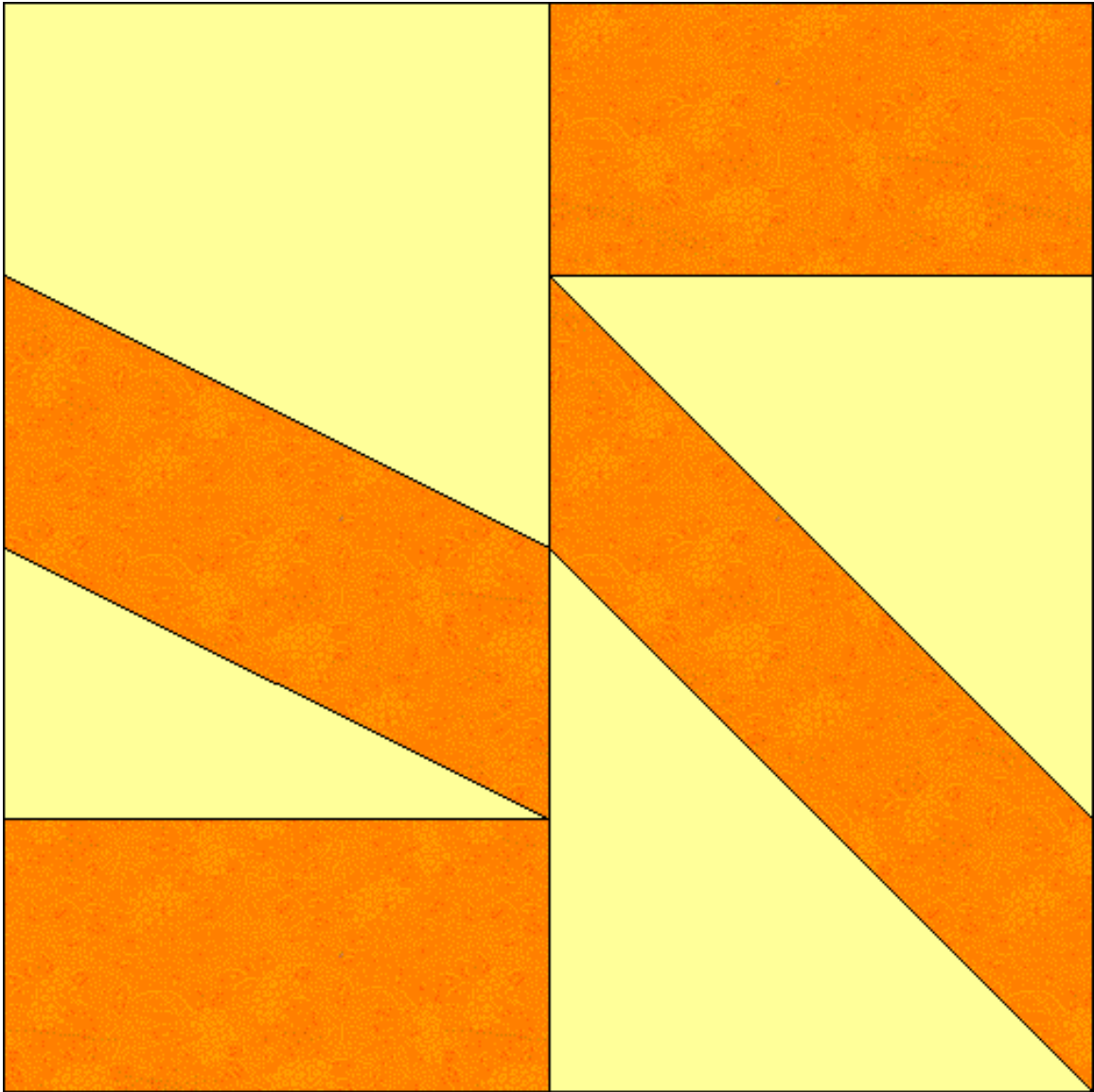

College Chain
Pattern for 8.00x8.00 block
Key Block (43/100 actual size)

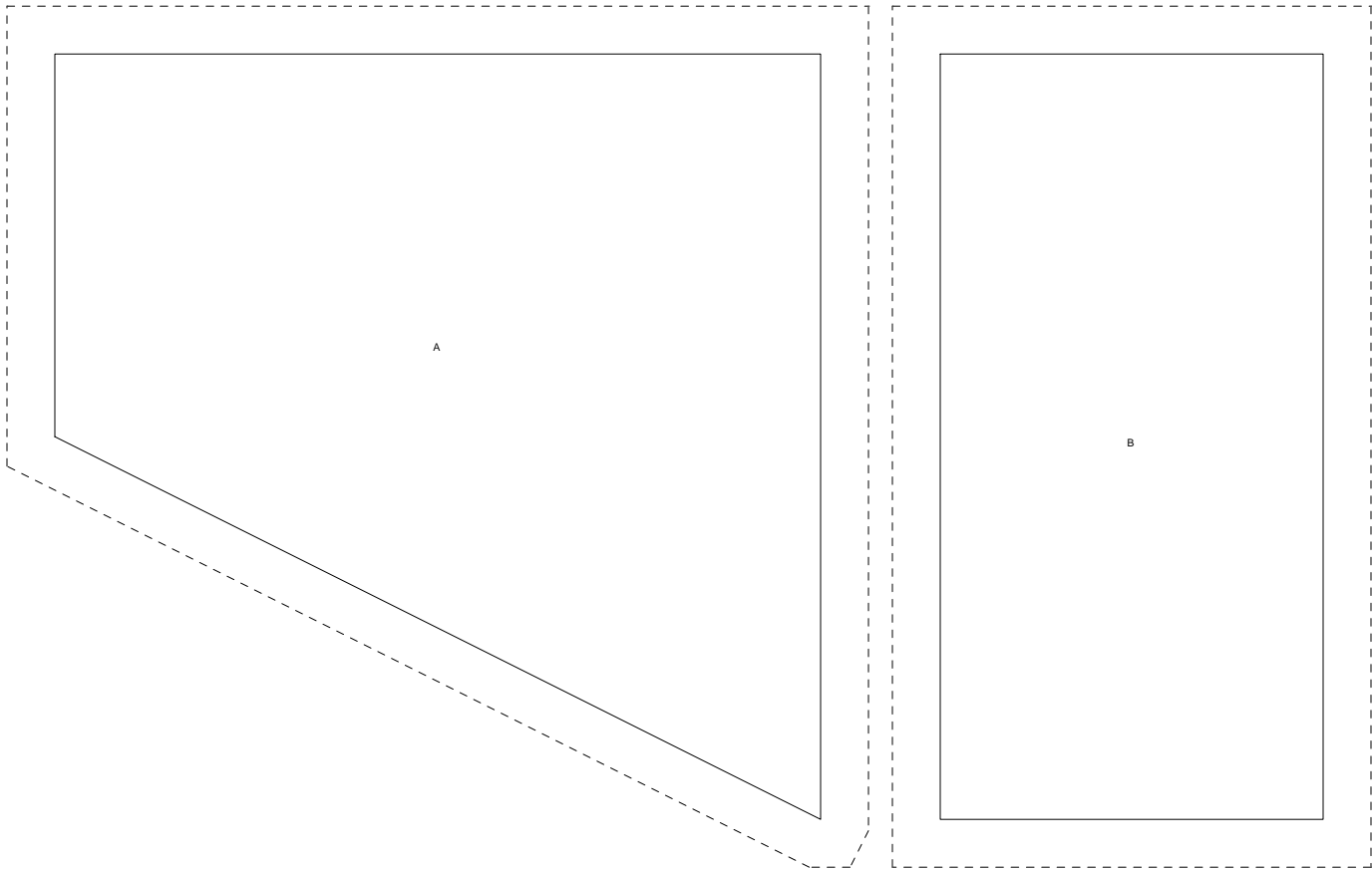
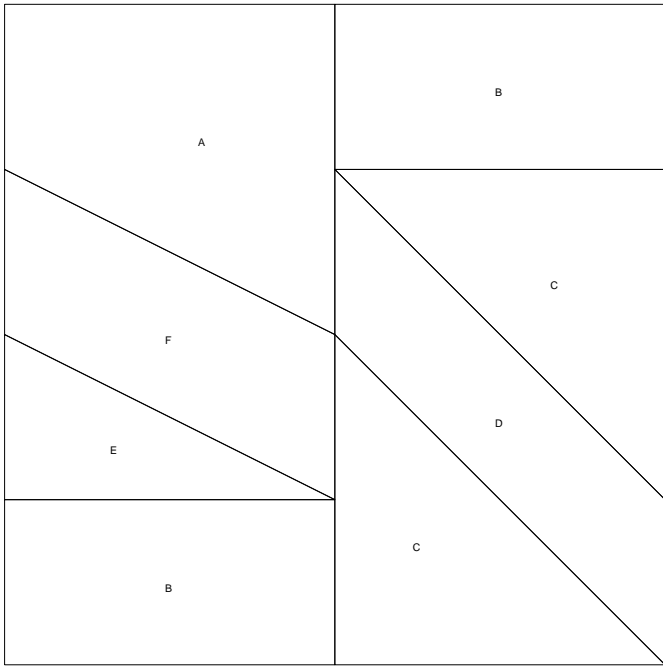

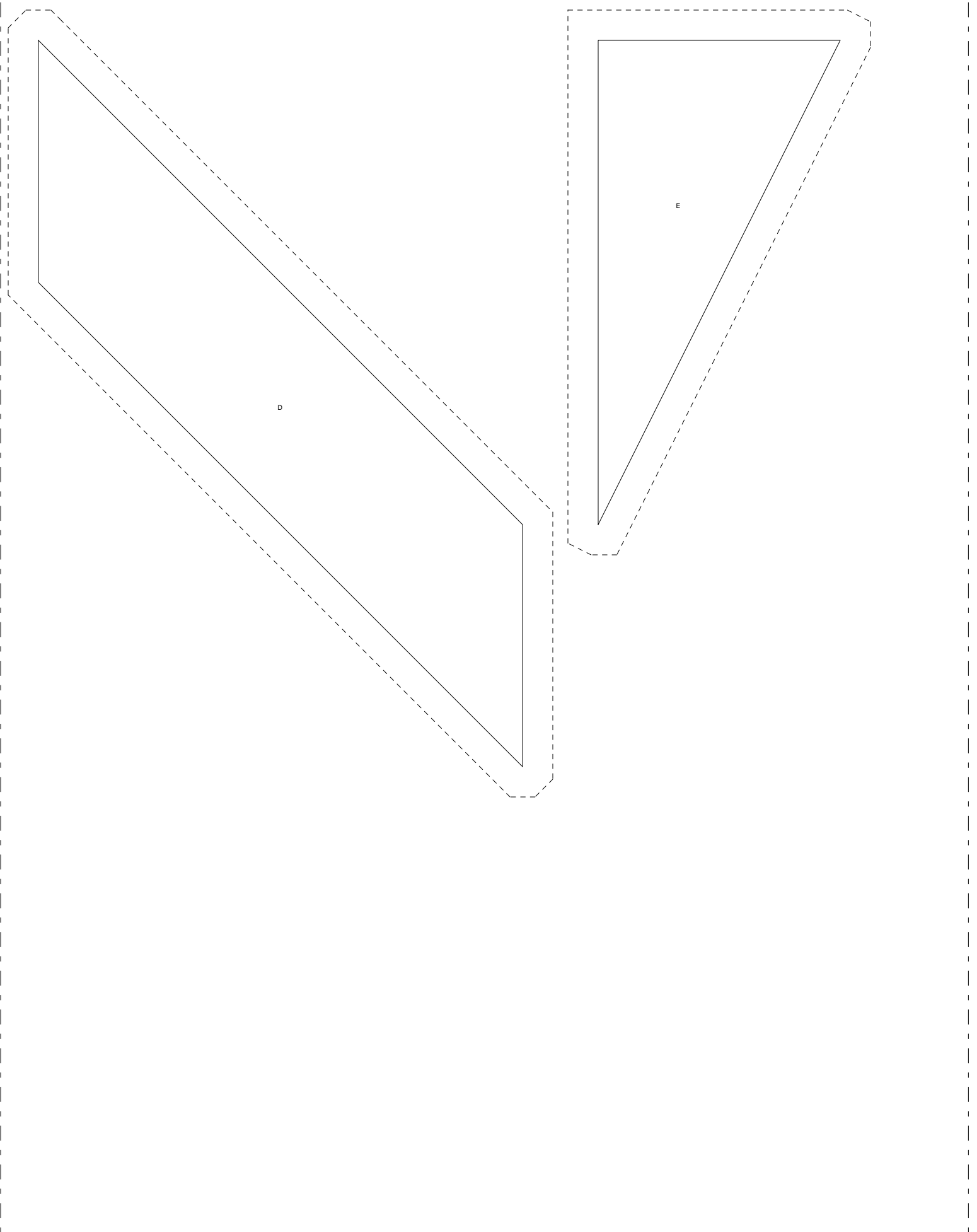

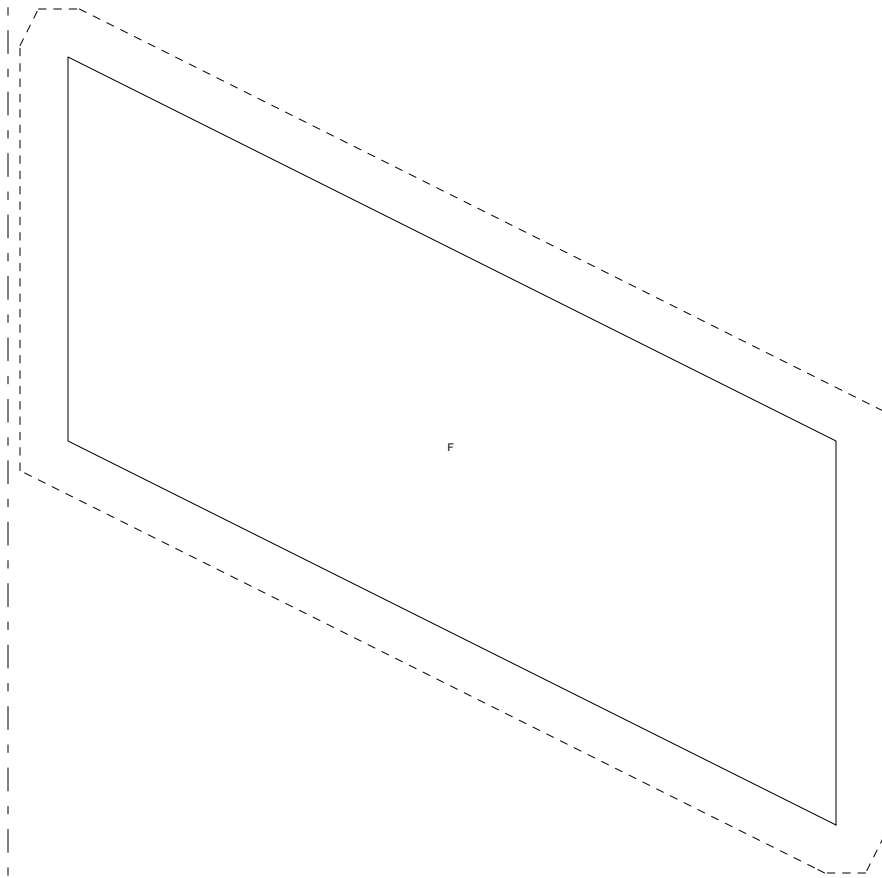
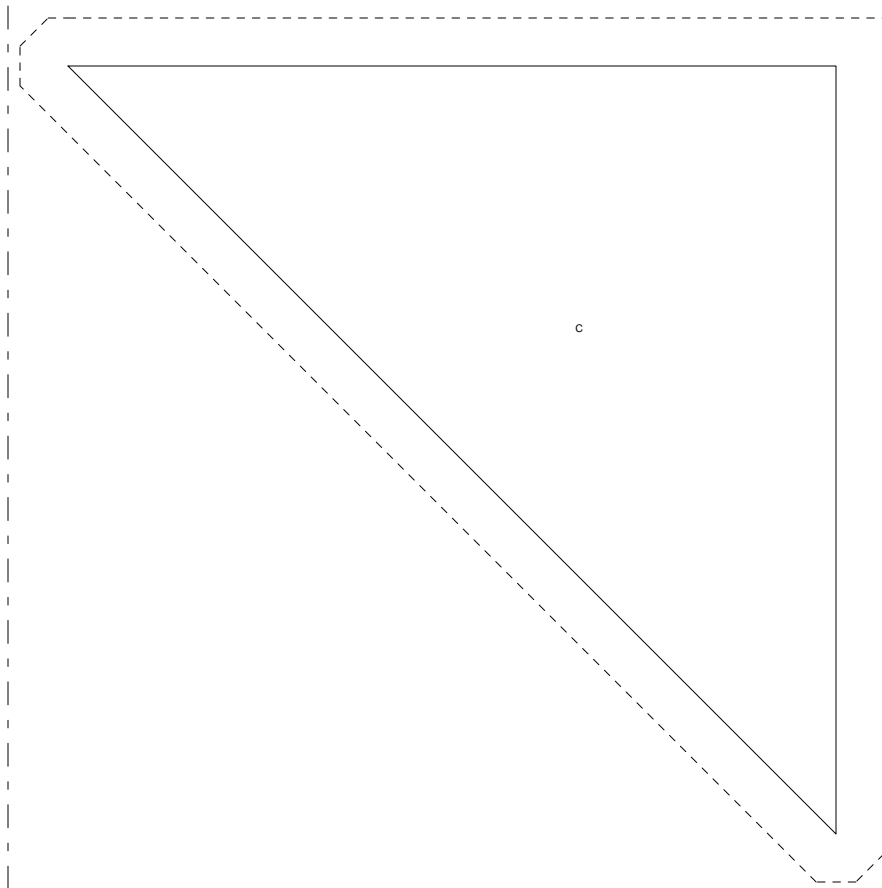

College Chain
 Pattern for 8.00x8.00 block
 Key Block (31/100 actual size)

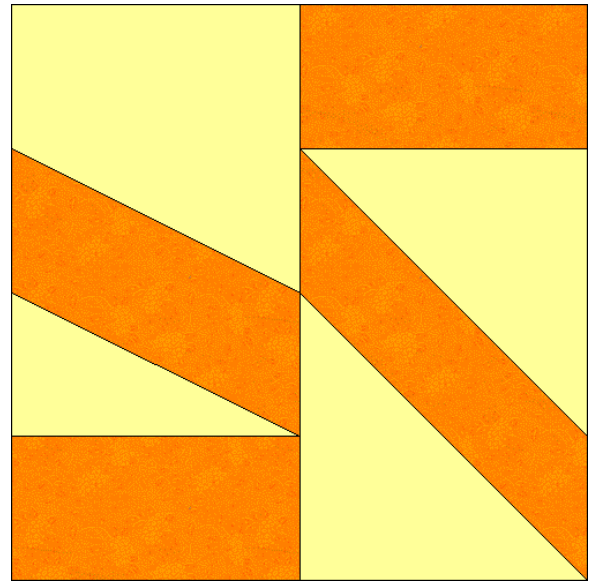
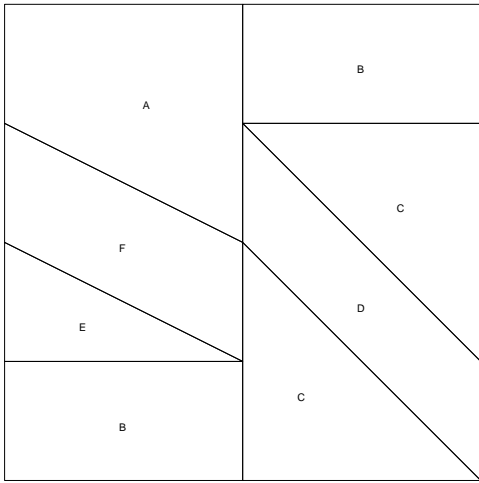

Cutting Diagrams

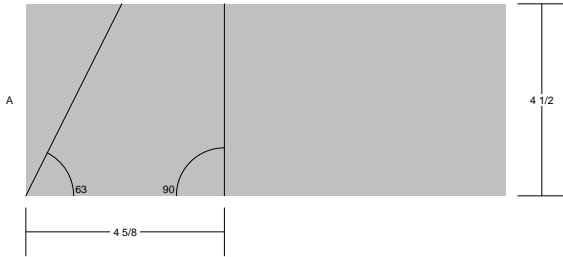

Patch Count

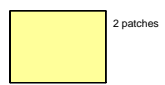
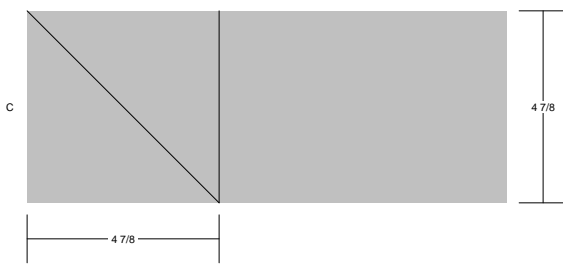
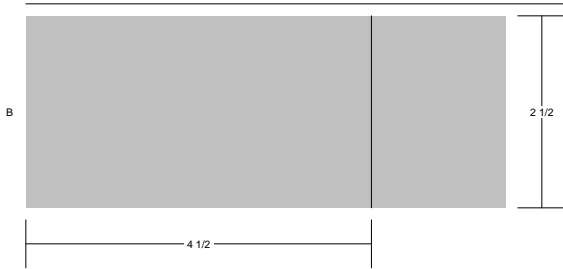

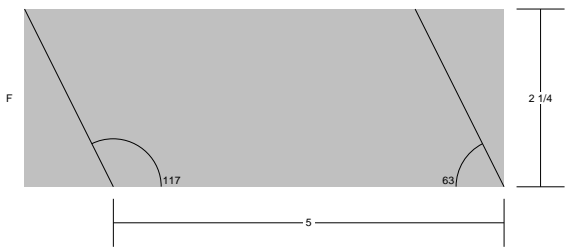
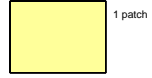
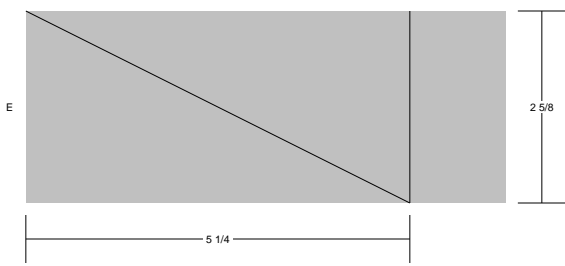
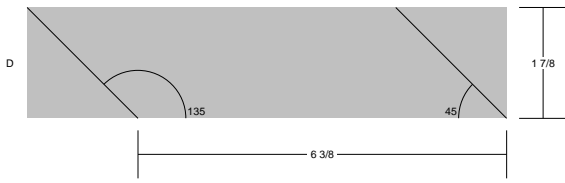

Double Necktie

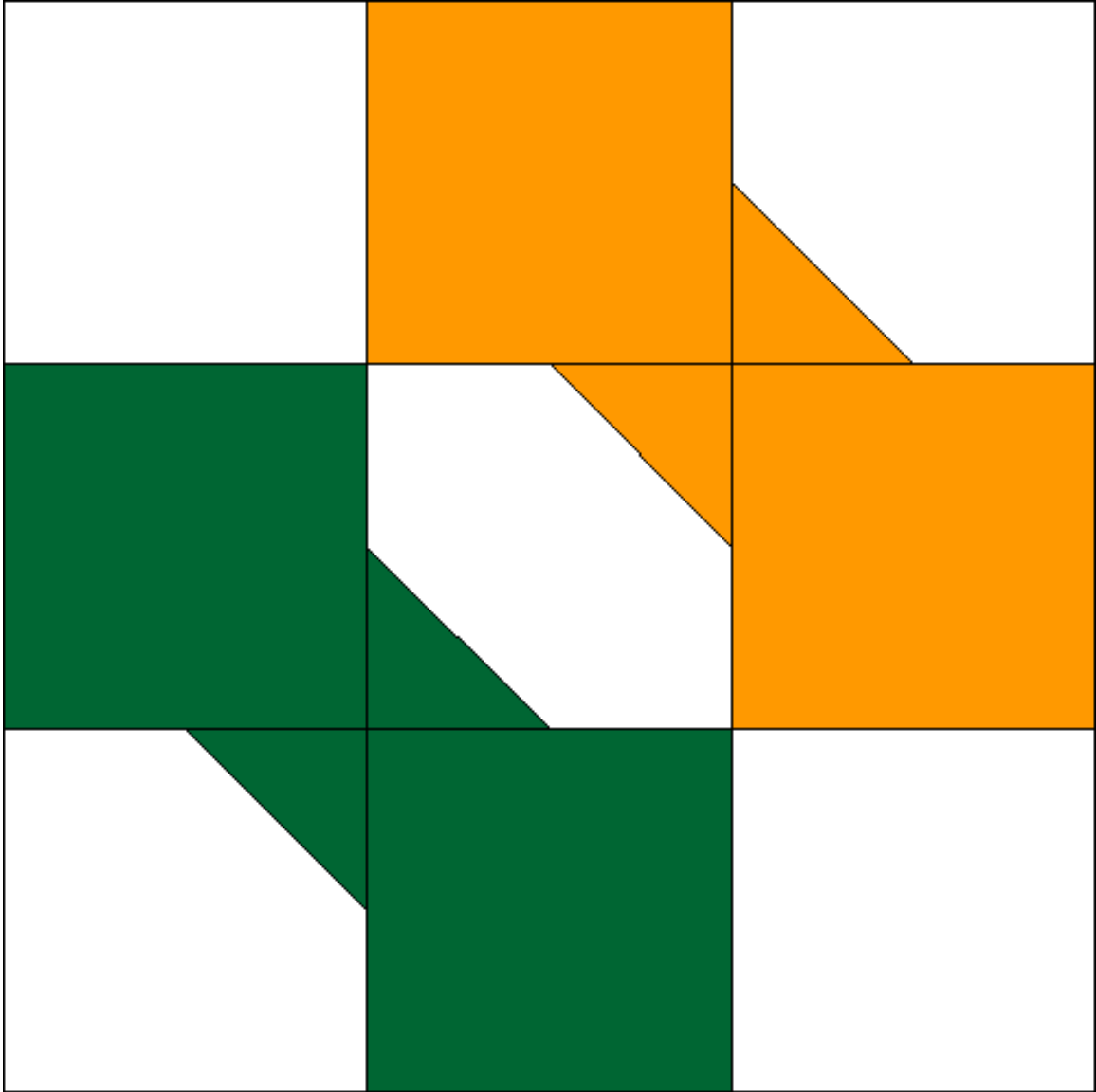

Double Necktie
Pattern for 9.00x9.00 block
Key Block (19/50 actual size)

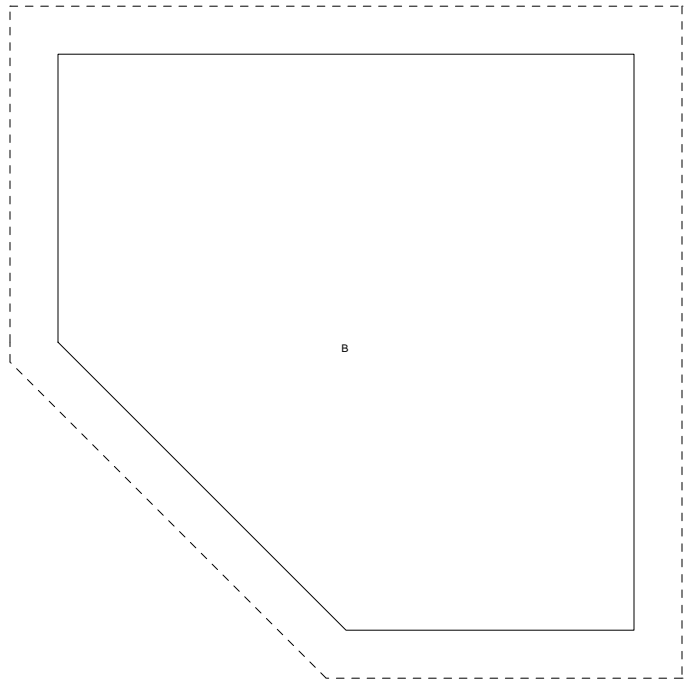
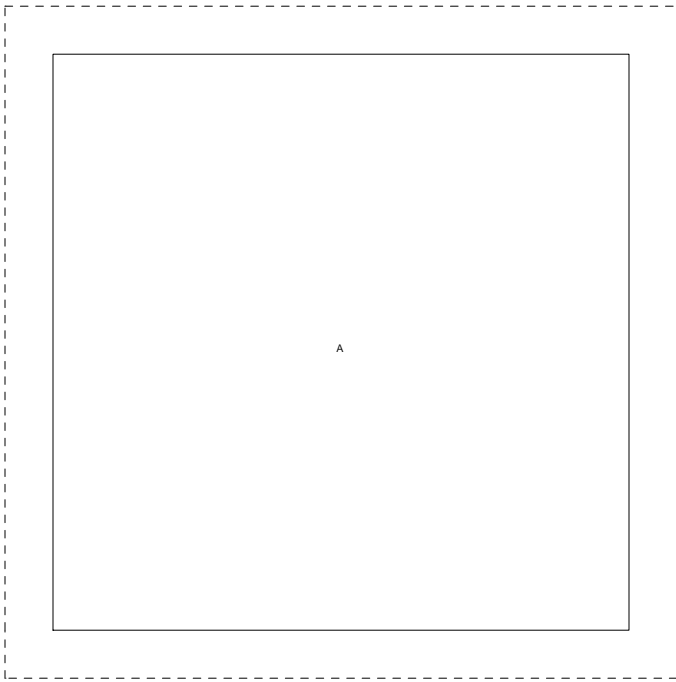
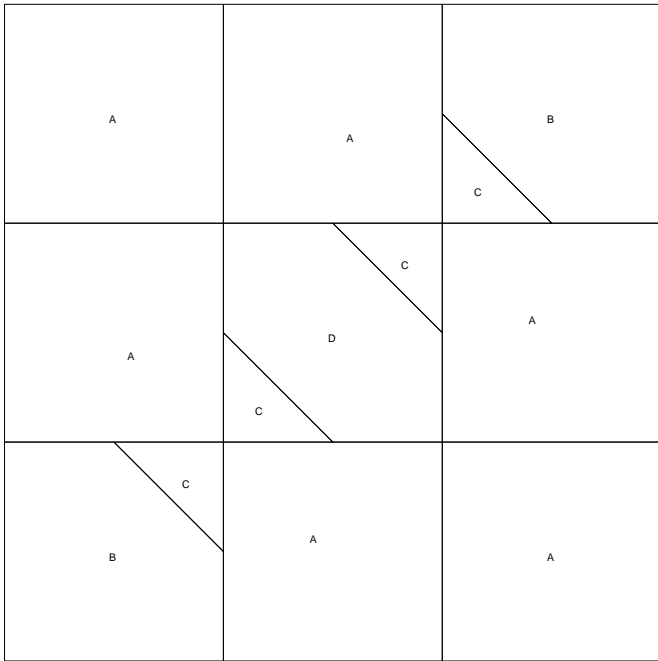

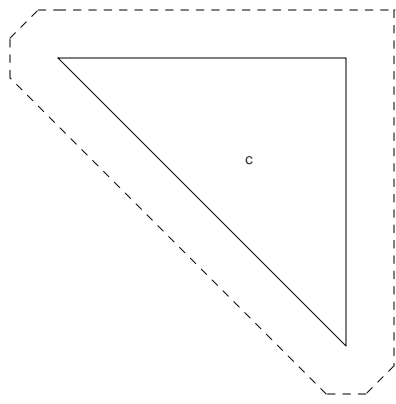
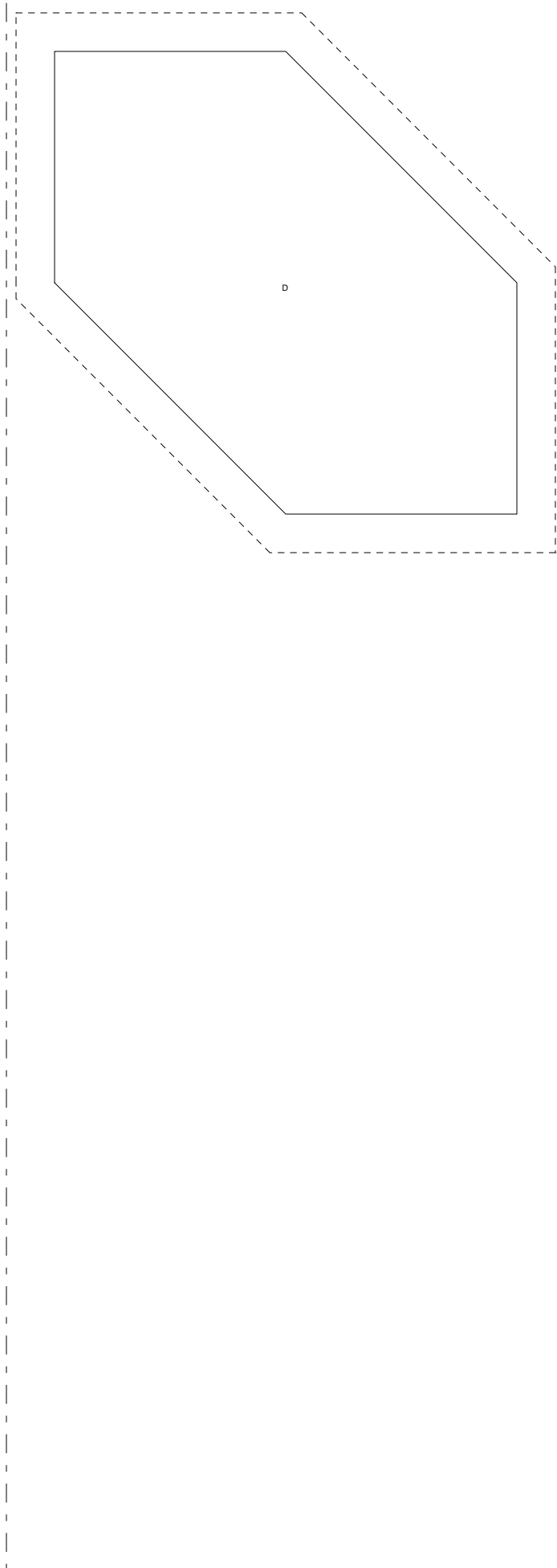

Double Necktie
 Pattern for 9.00x9.00 block
 Key Block (27/100 actual size)

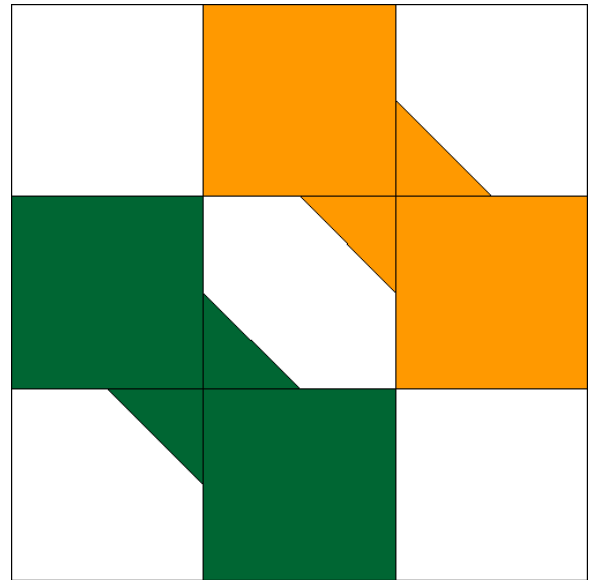
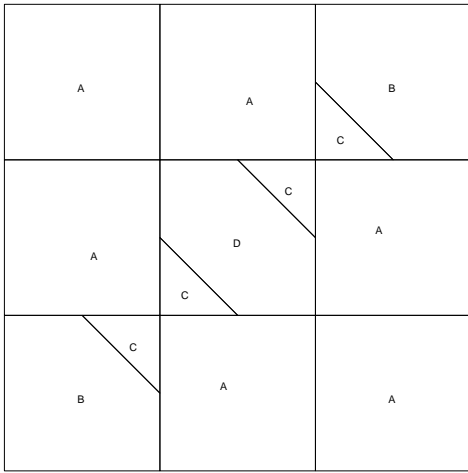

Cutting Diagrams

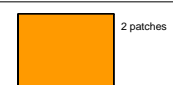
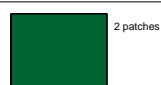
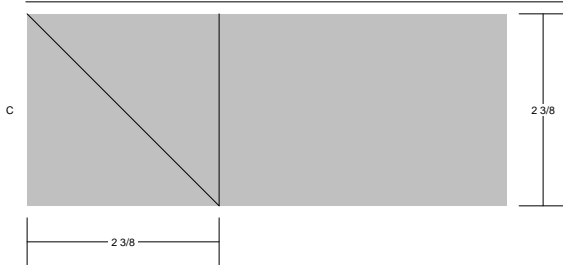
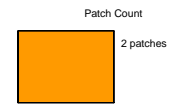
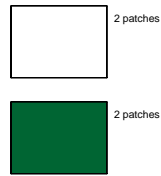

Forest Paths

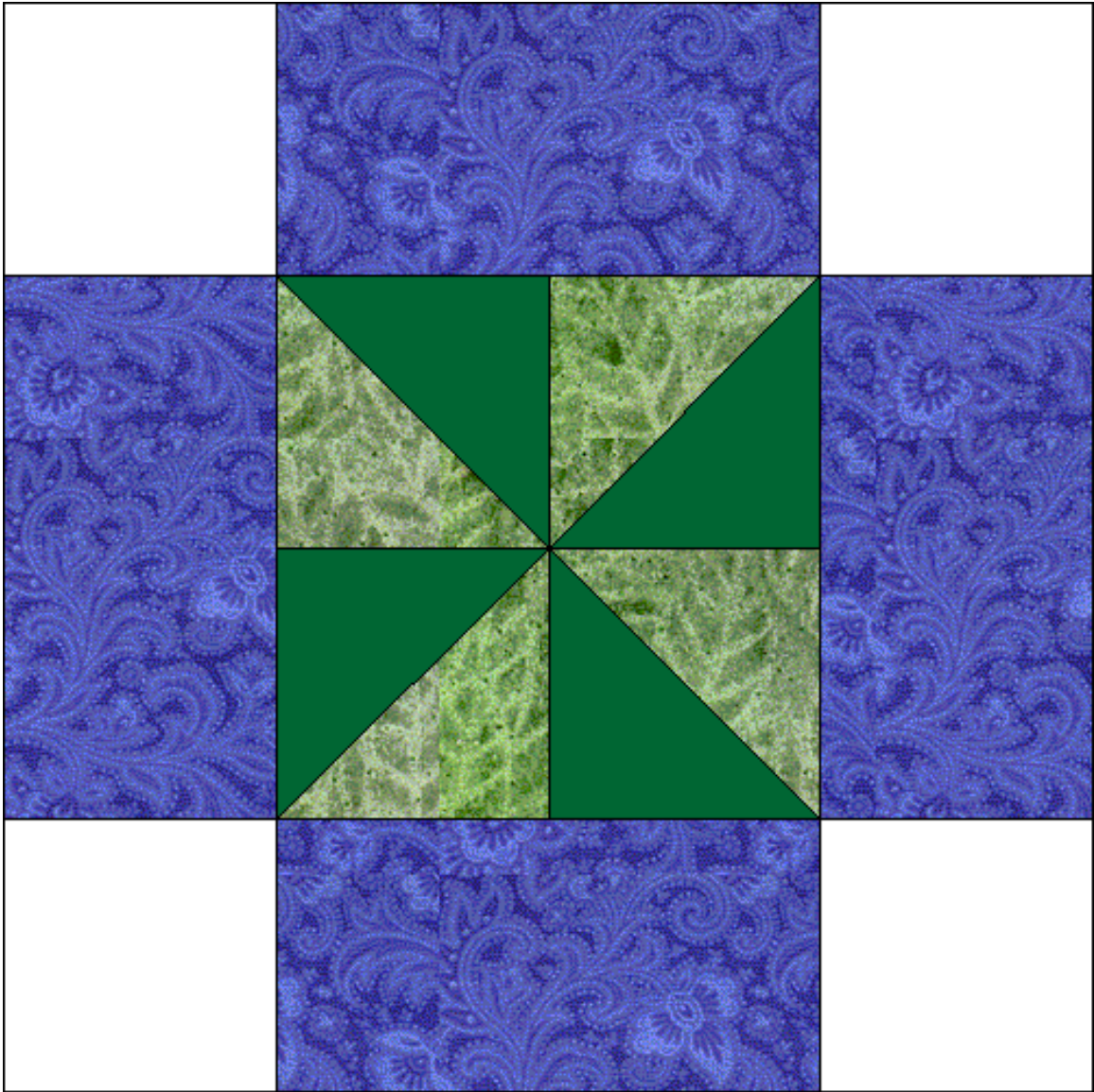

Forest Paths
Pattern for 8.00x8.00 block
Key Block (43/100 actual size)

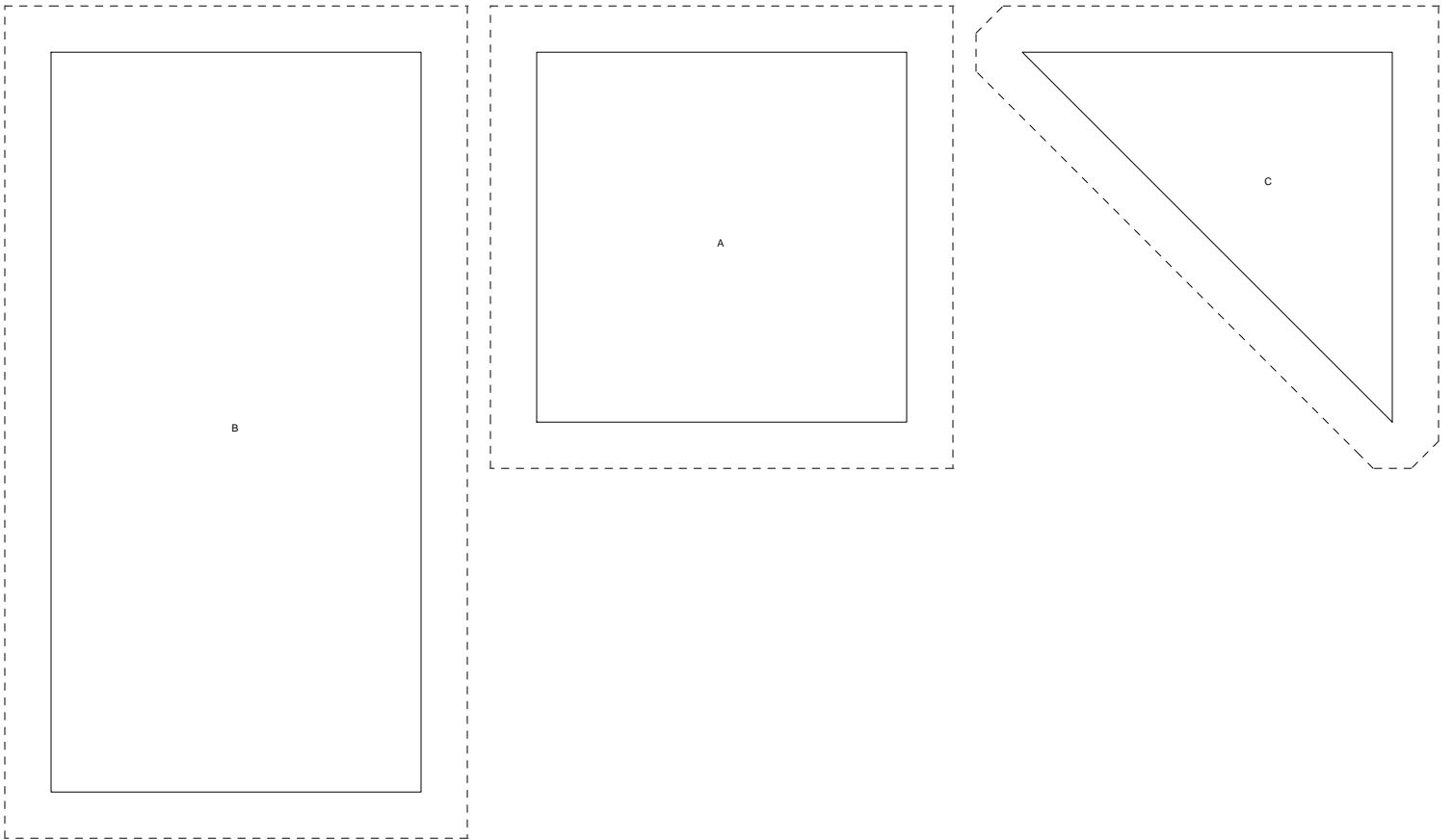
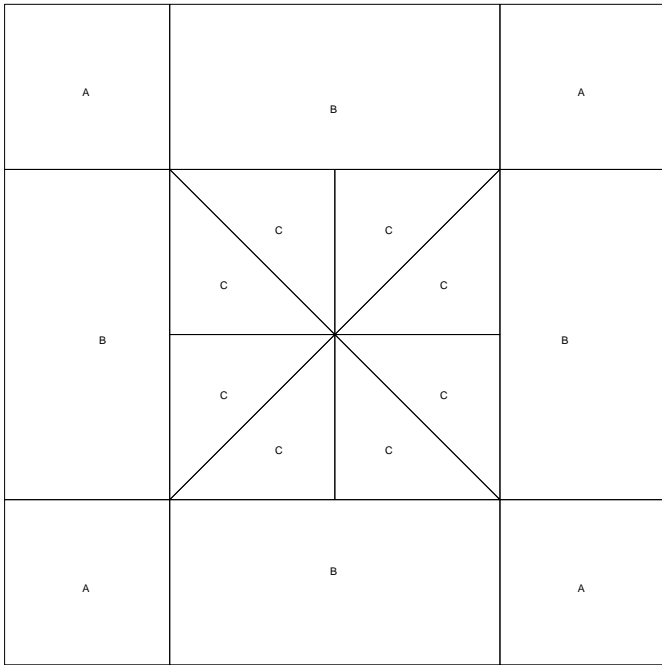

Forest Paths
 Pattern for 8.00x8.00 block
 Key Block (31/100 actual size)

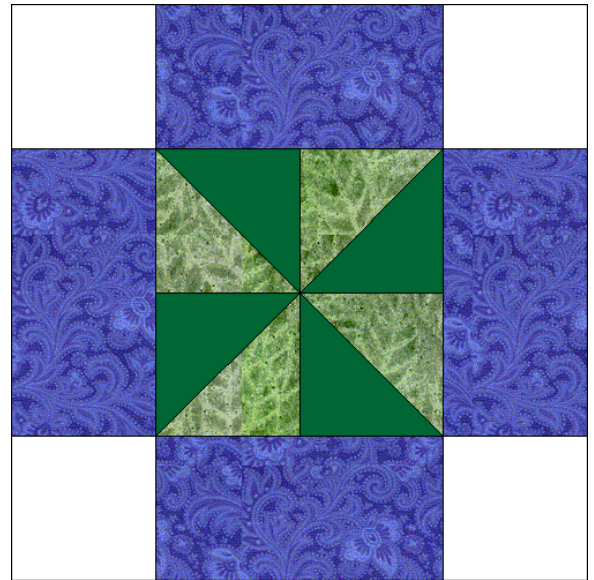
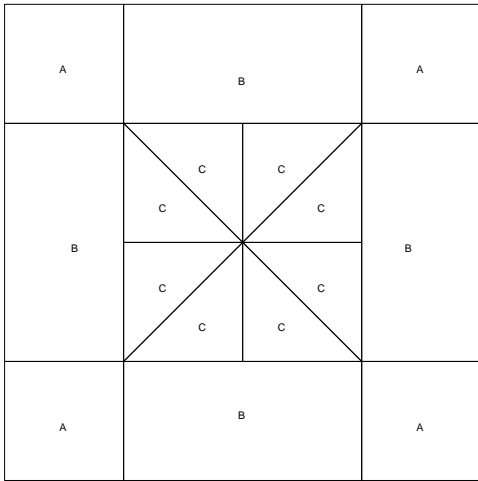

Cutting Diagrams



Patch Count

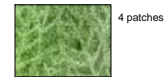
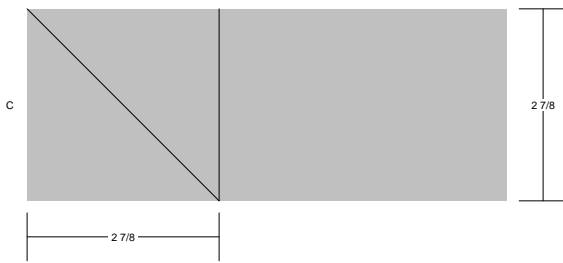
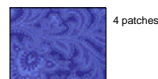
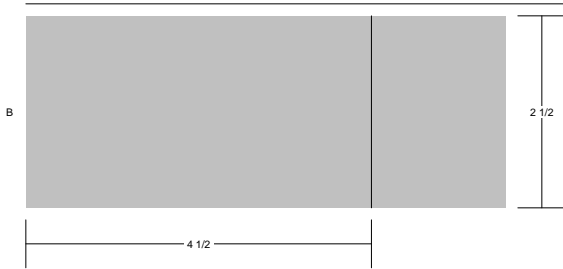

Heart Log Cabin

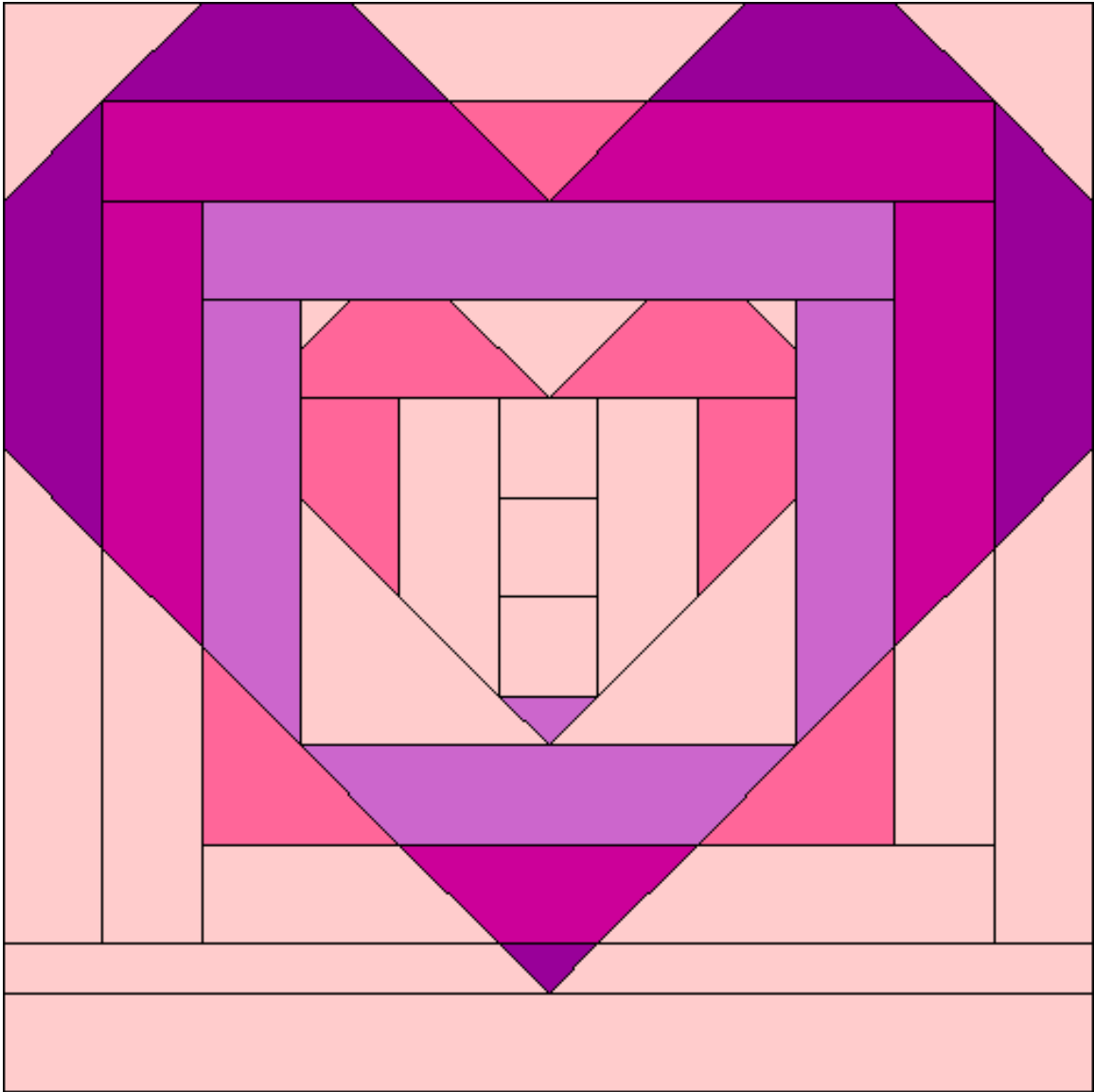

Heart Log Cabin

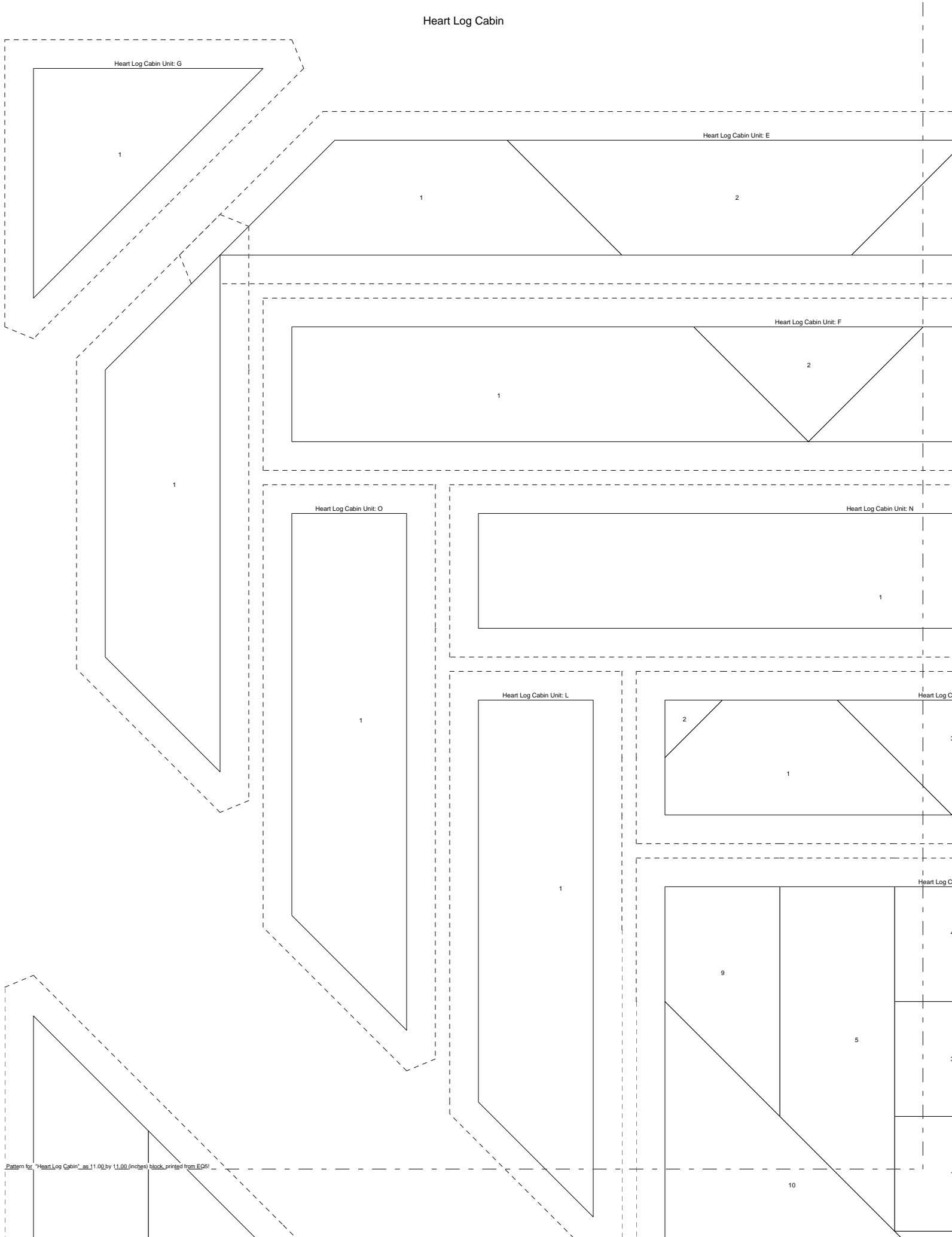

Heart Log Cabin Unit: G

1

Heart Log Cabin Unit: E

1

2

Heart Log Cabin Unit: F

2

1

1

Heart Log Cabin Unit: O

1

Heart Log Cabin Unit: N

1

Heart Log Cabin Unit: L

1

Heart Log Cabin Unit: M

2

1

Heart Log Cabin Unit: K

9

5

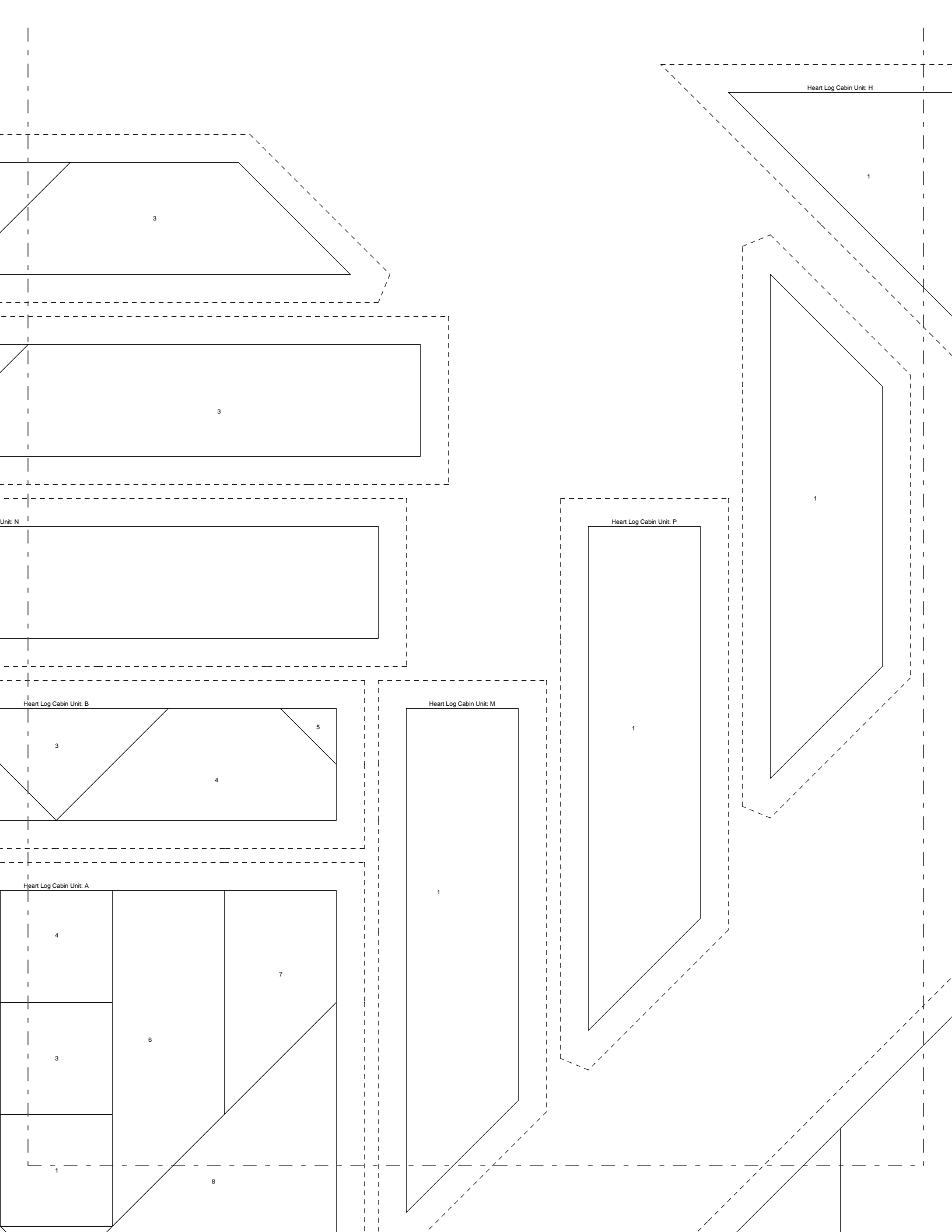

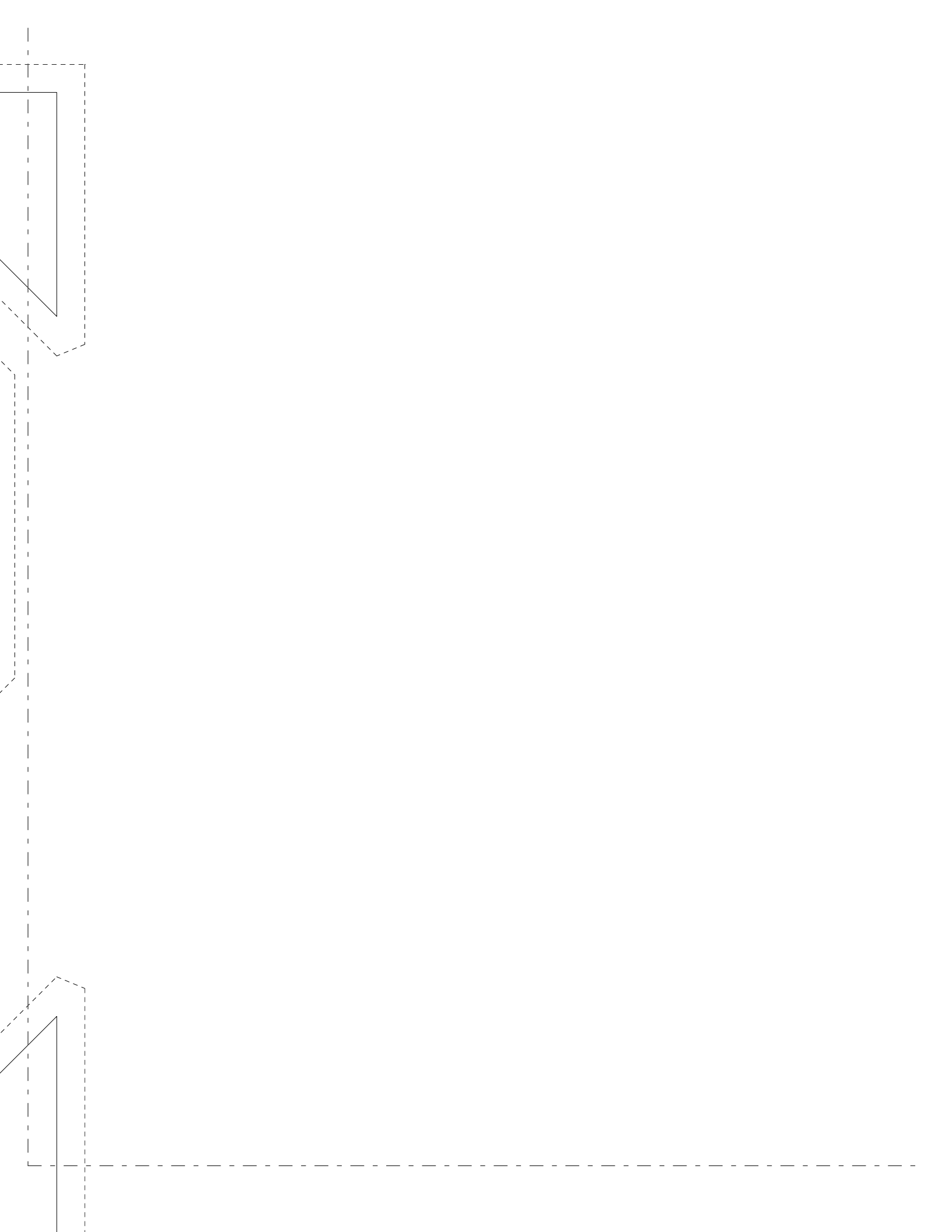

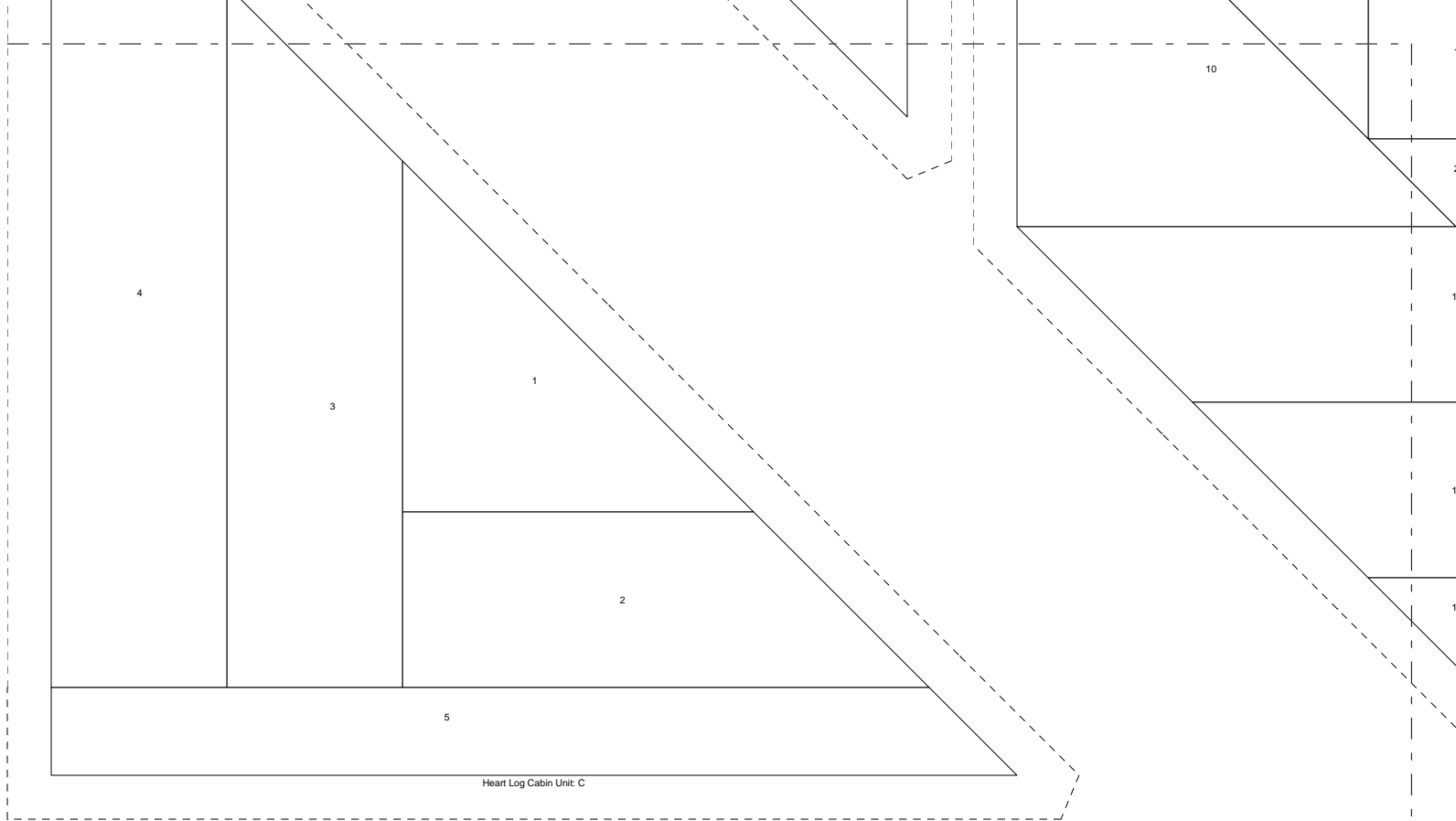

Heart Log Cabin Unit: C

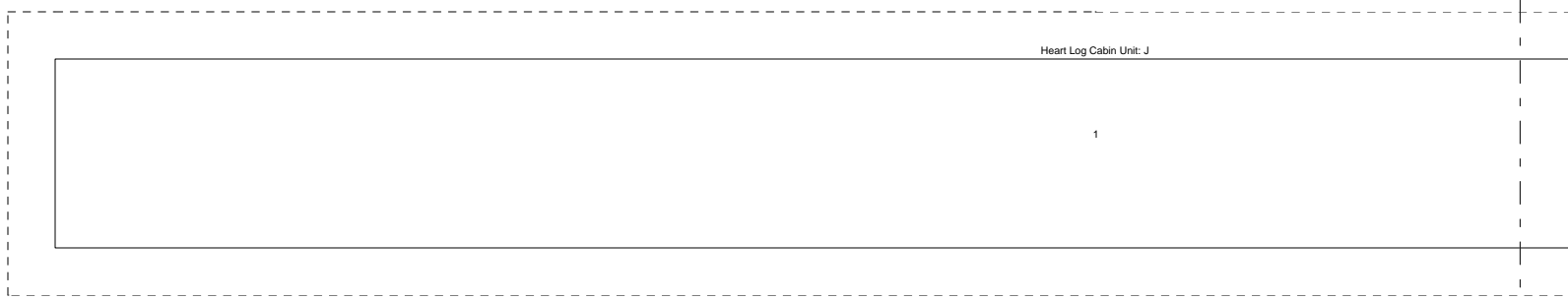

Heart Log Cabin Unit: J

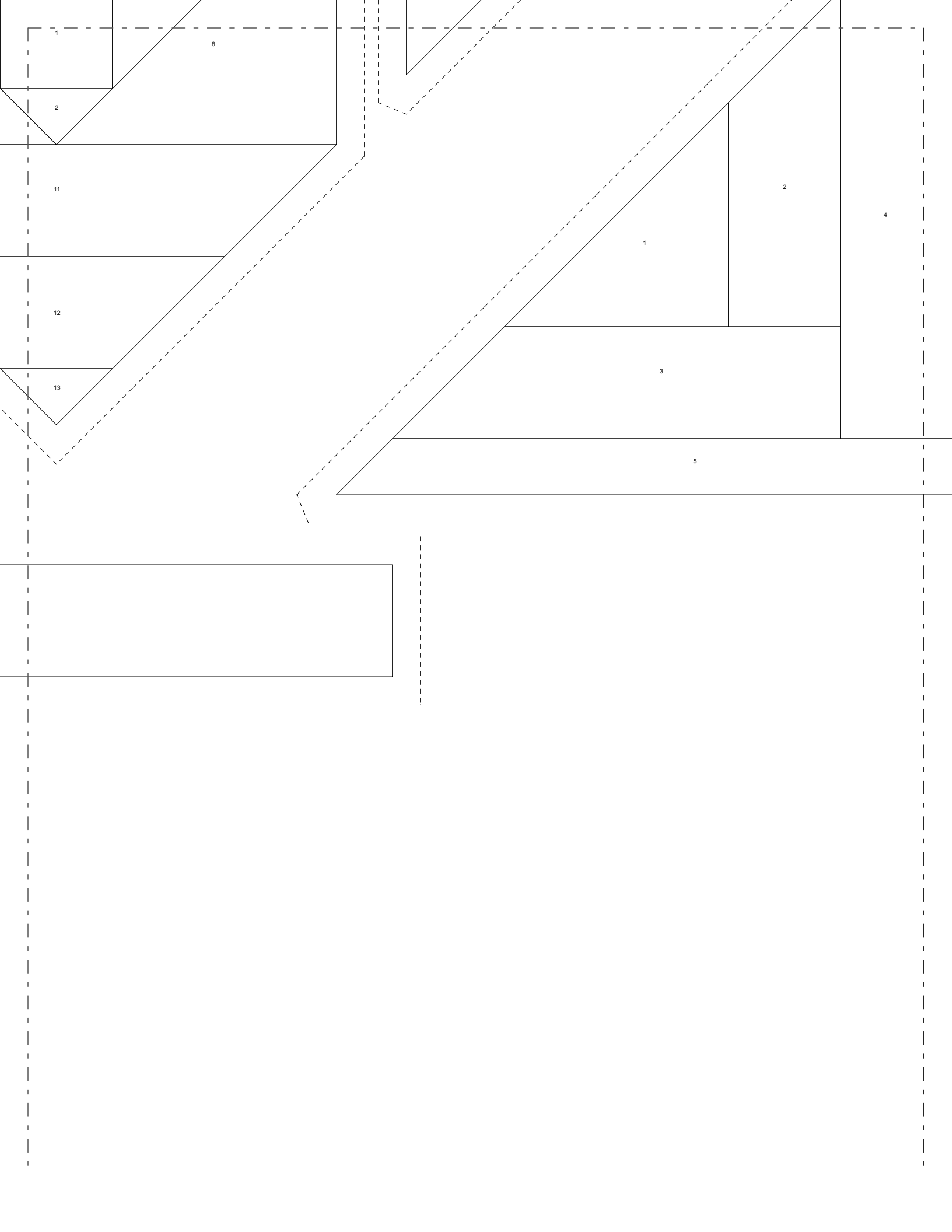

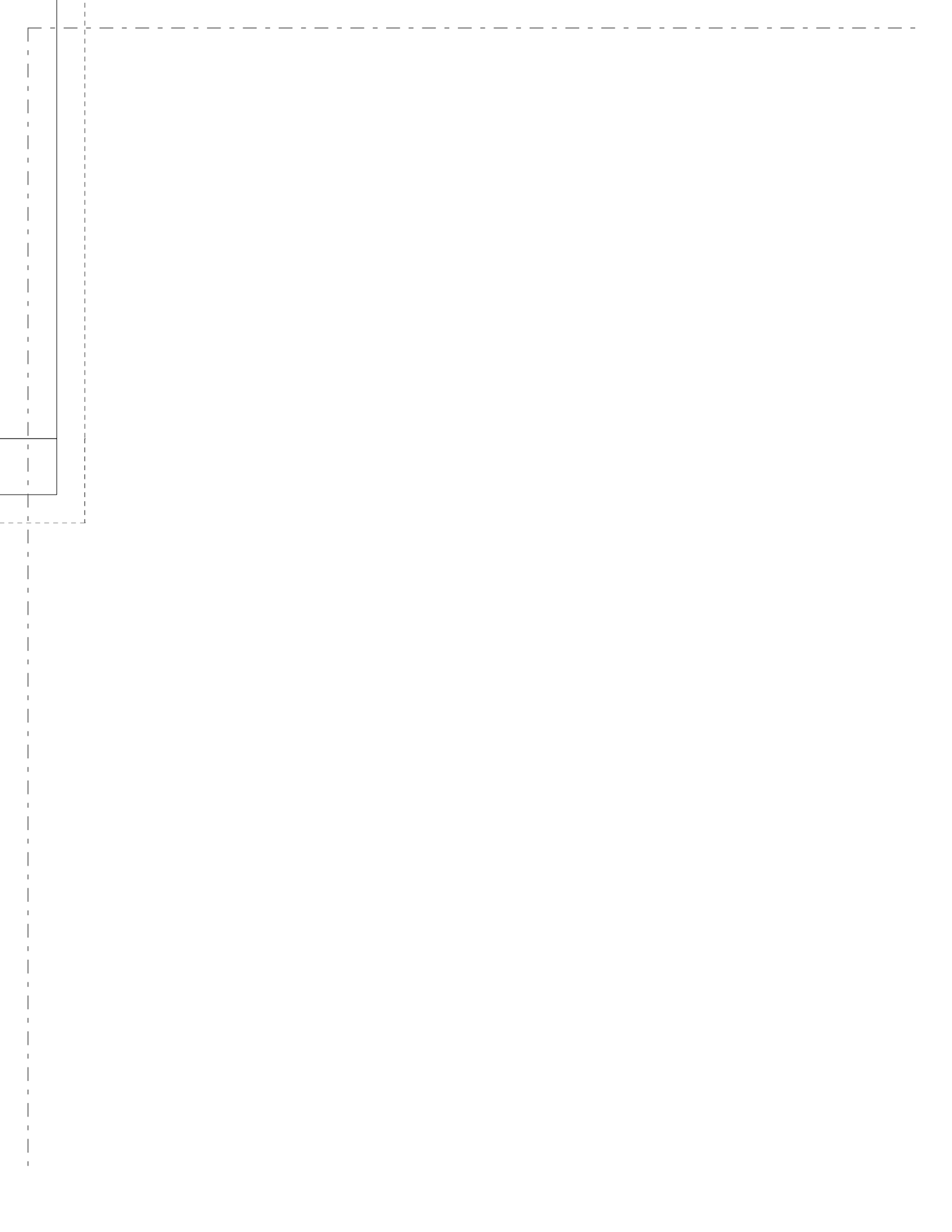

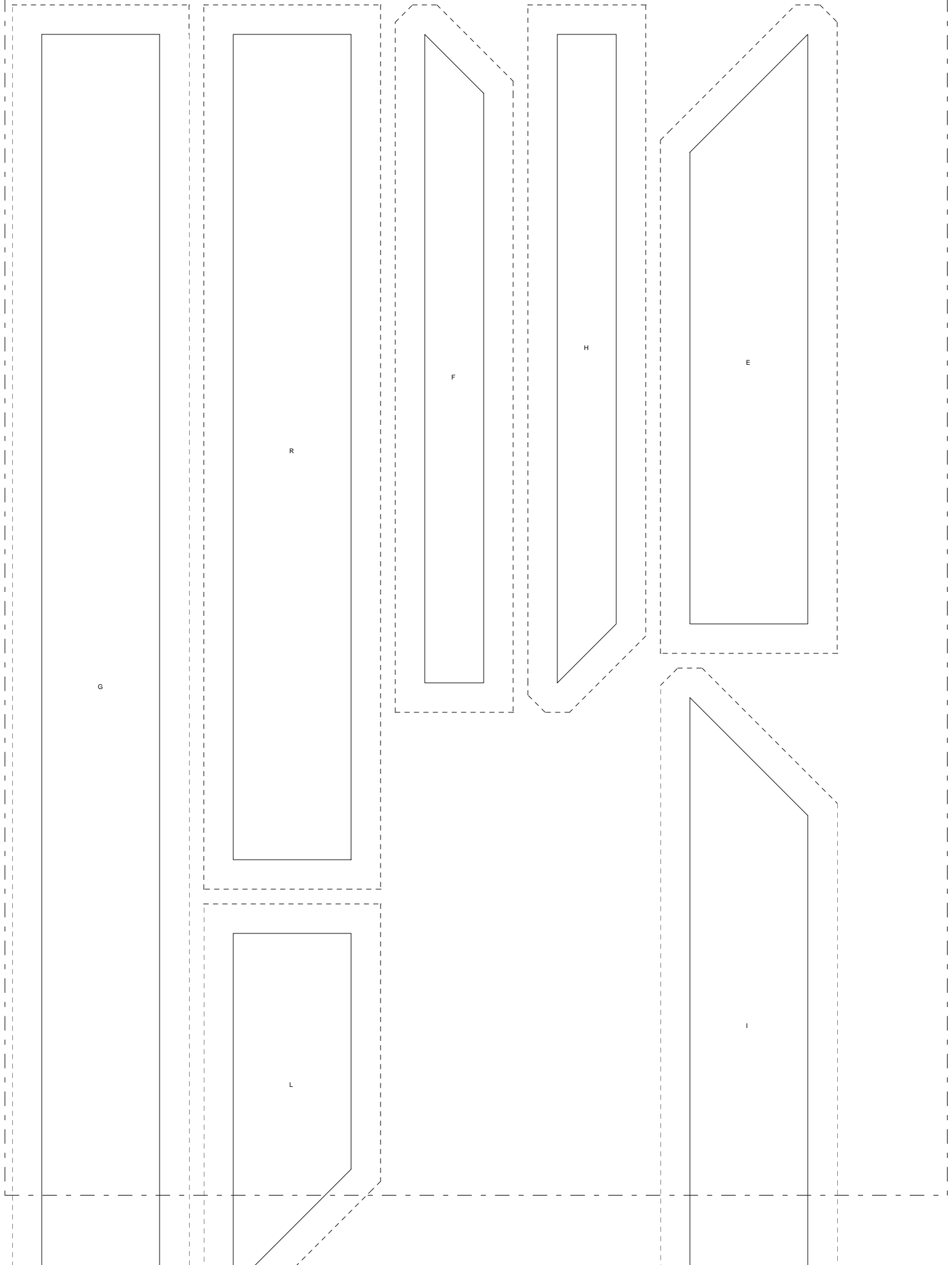

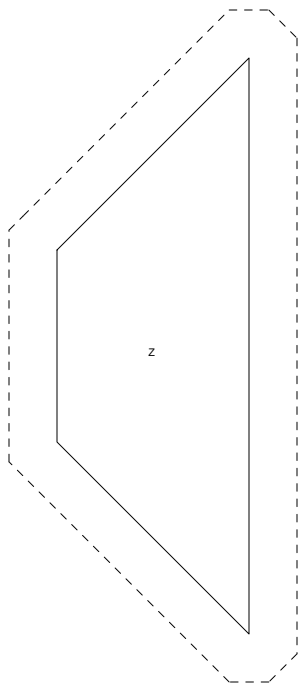

Z

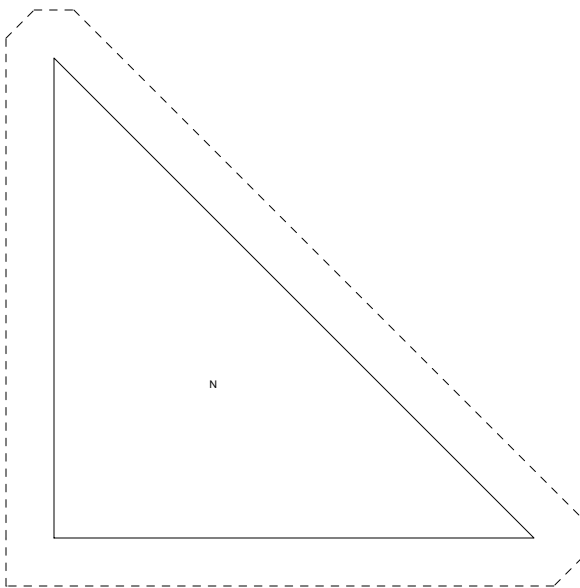

N

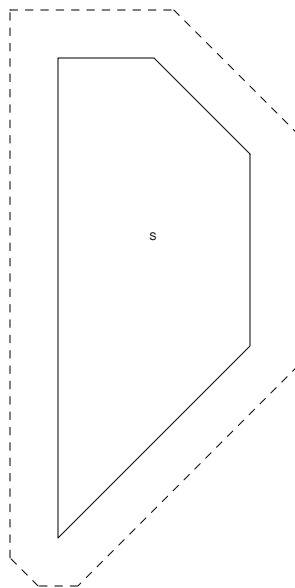

S

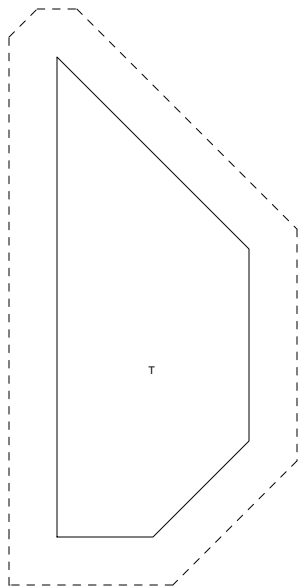

T

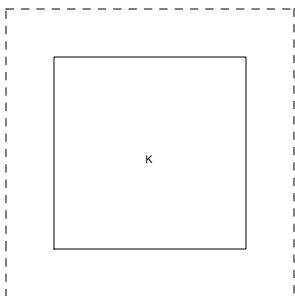

K

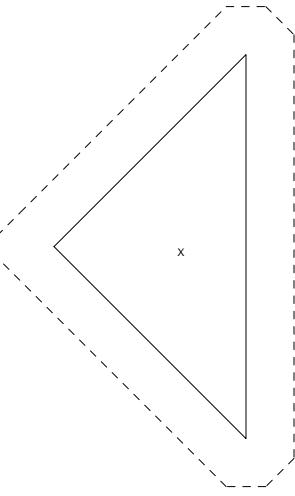
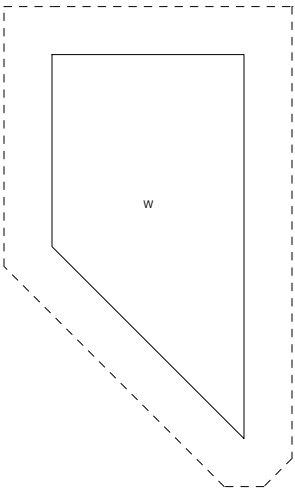
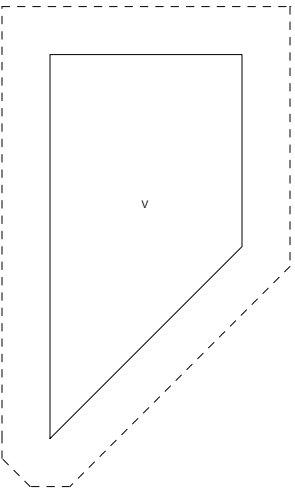
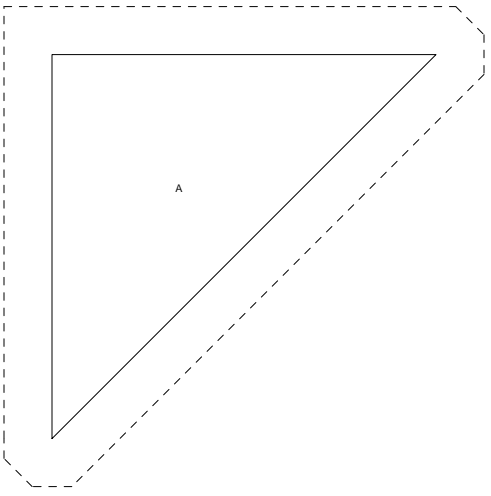
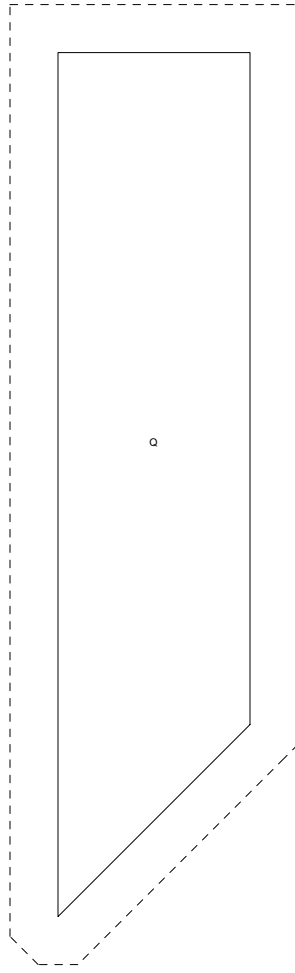
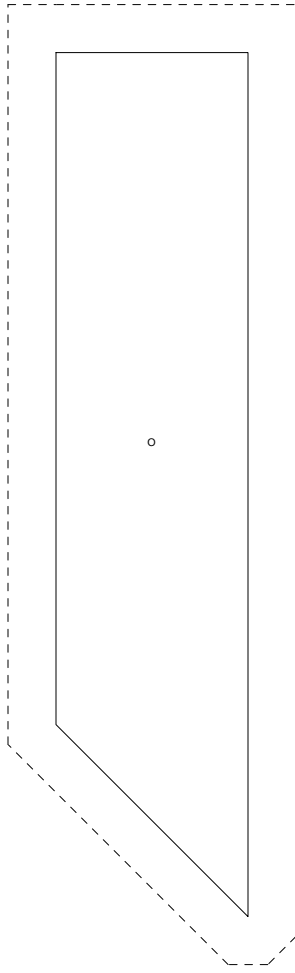
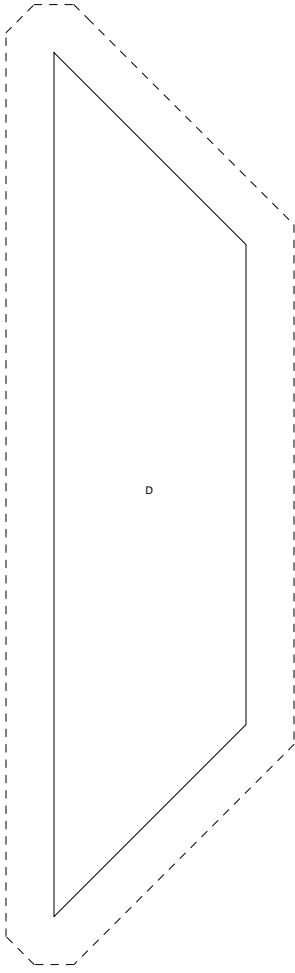
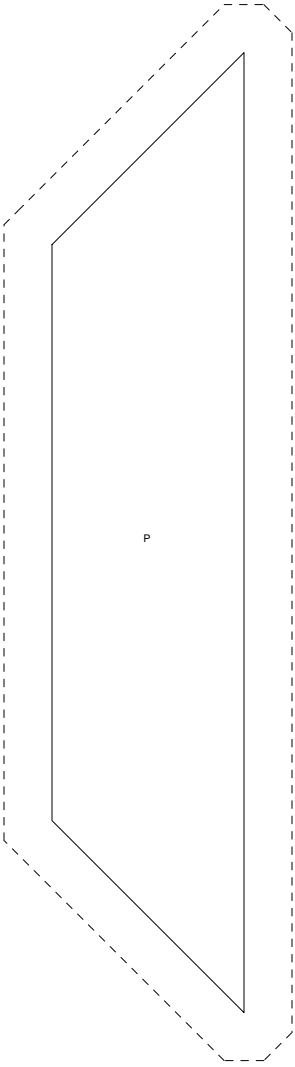
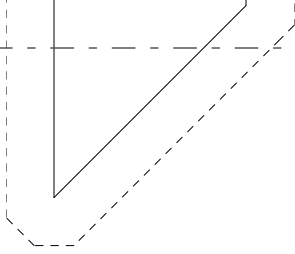
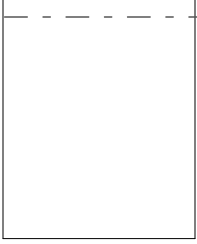

Heart Log Cabin
 Pattern for 11.00x11.00 block
 Key Block (11/50 actual size)

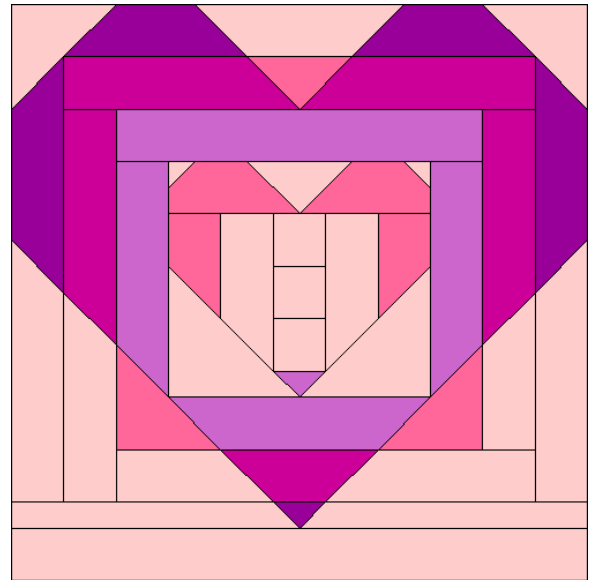
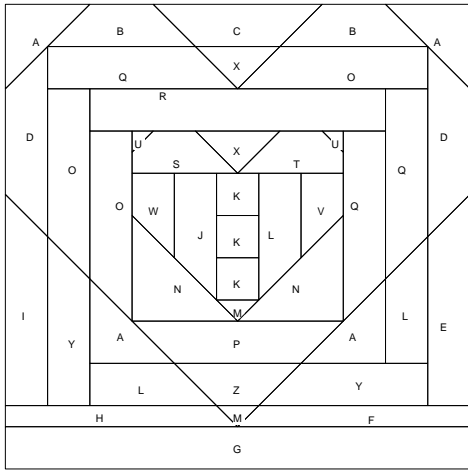

Cutting Diagrams

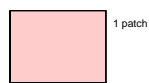
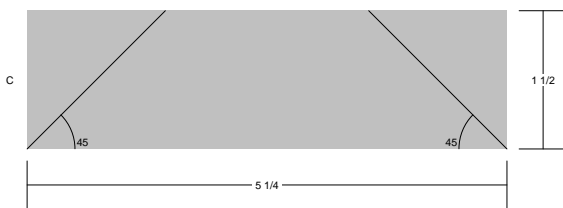
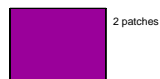
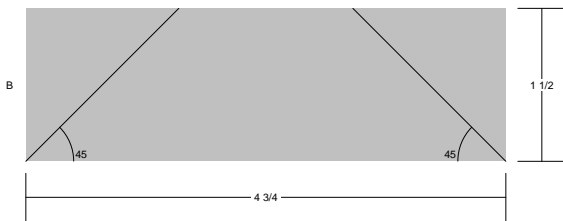
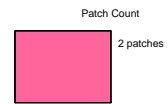
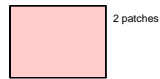
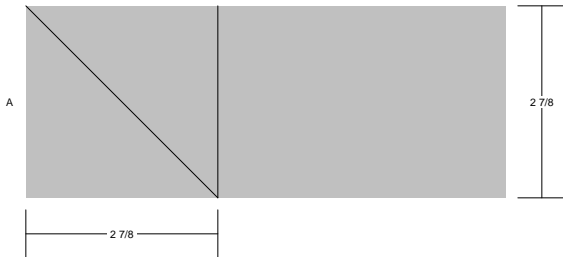

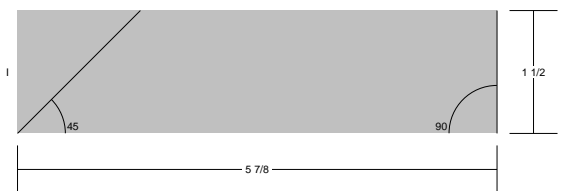
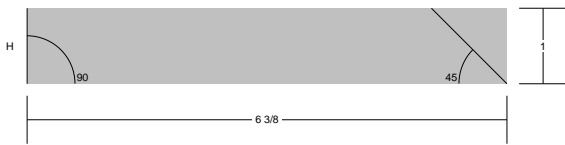
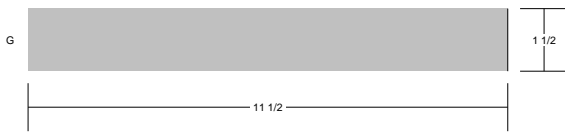
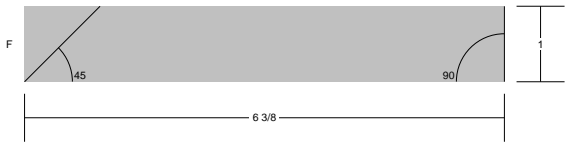
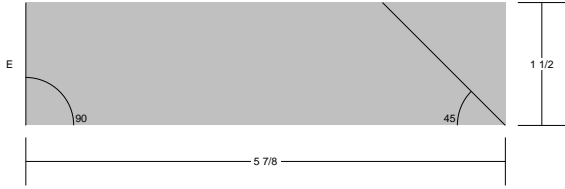
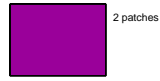
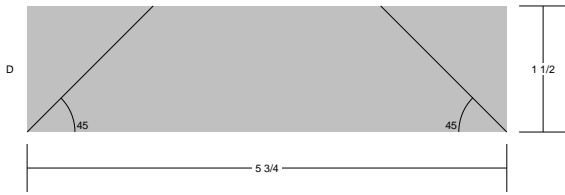

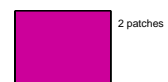
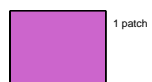
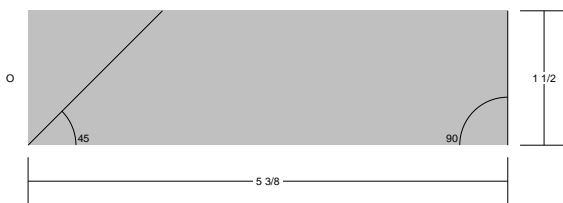
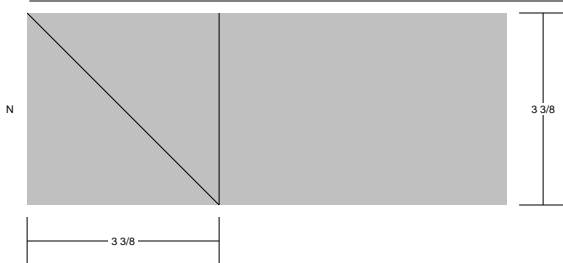
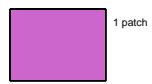
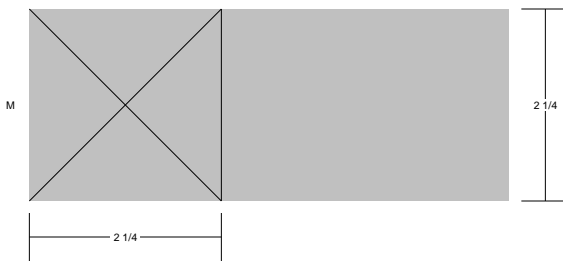
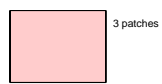
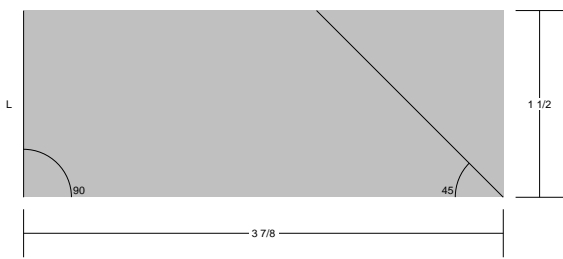
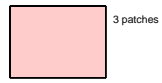
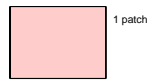
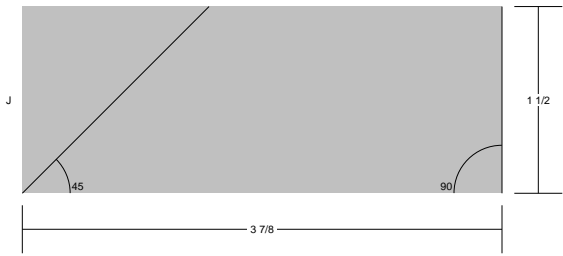

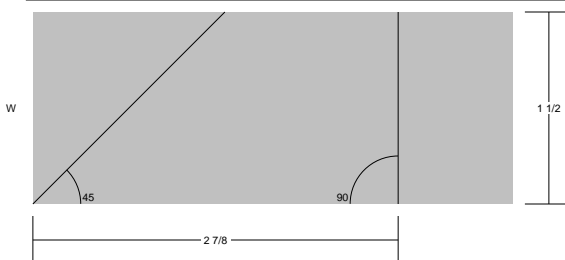
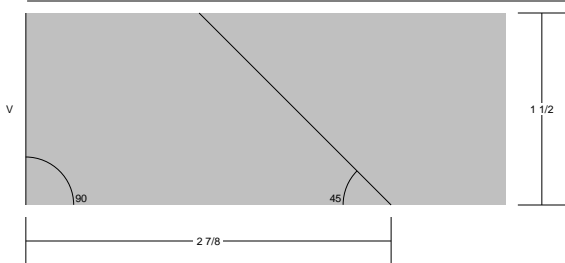
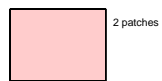
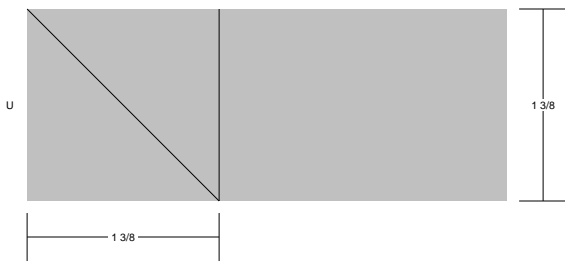
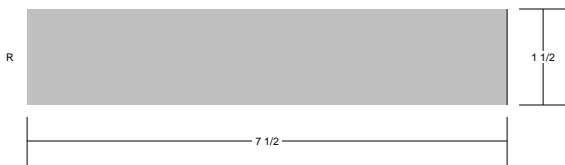
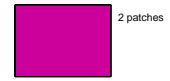
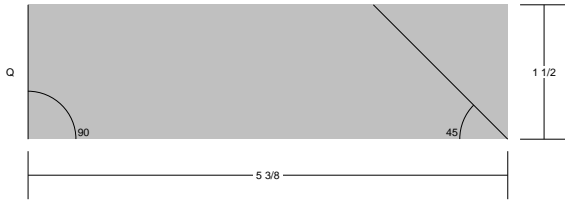
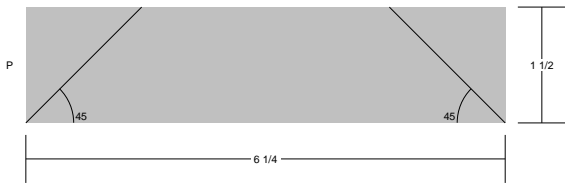

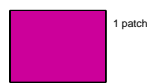
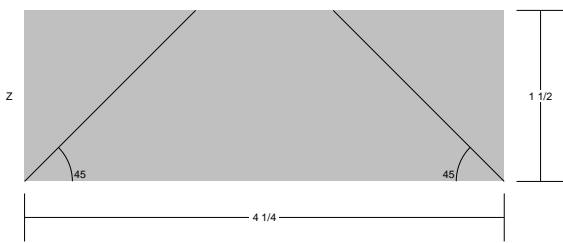
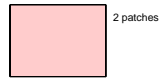
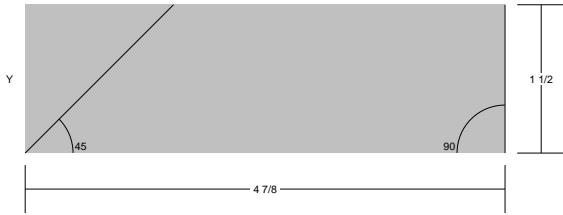
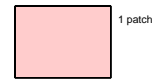
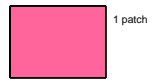
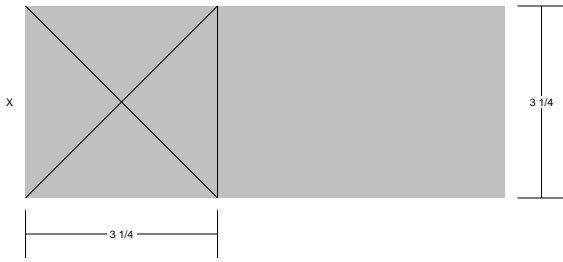

Hearts

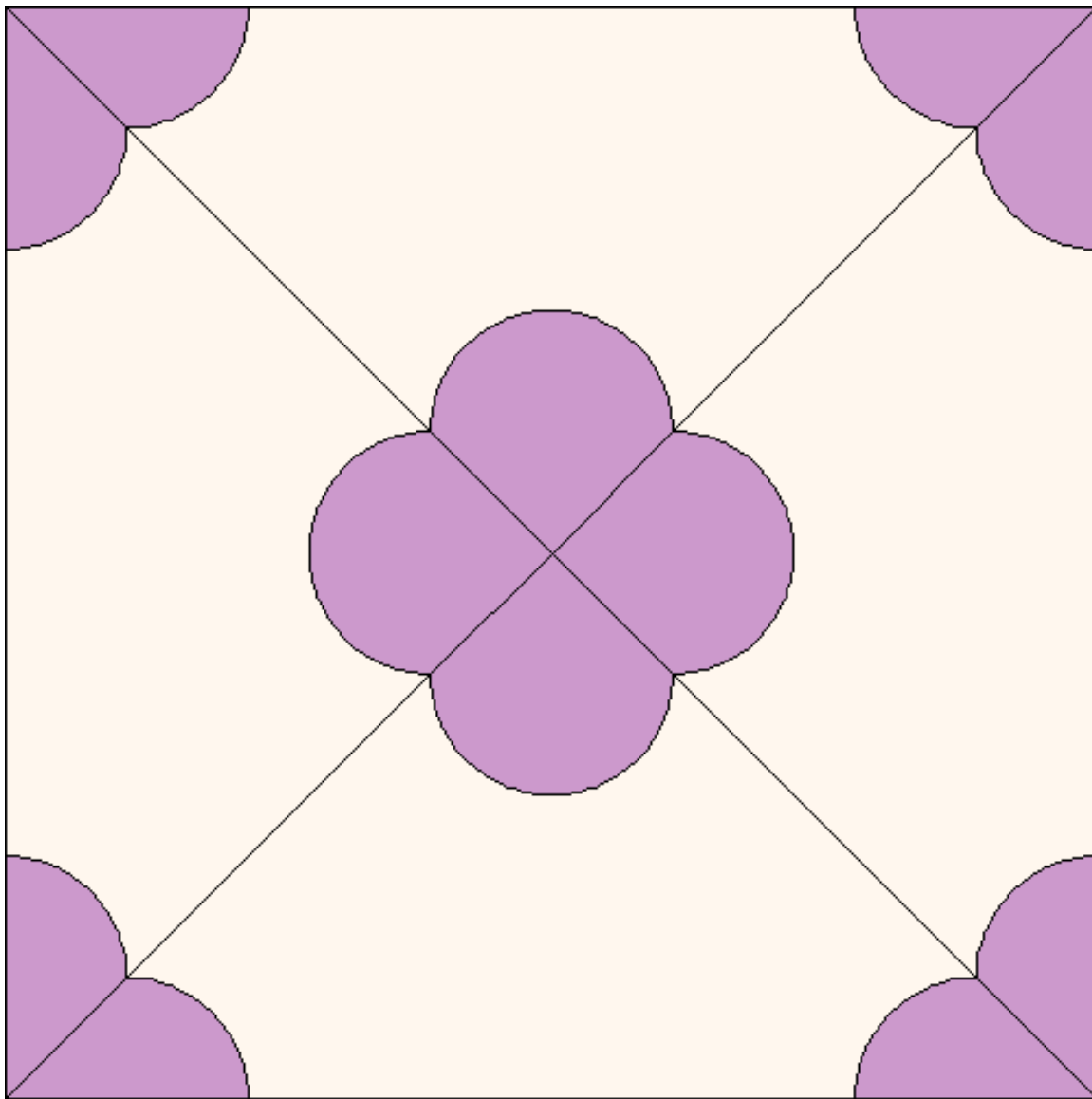

Hearts
Pattern for 9.00x9.00 block
Key Block (19/50 actual size)

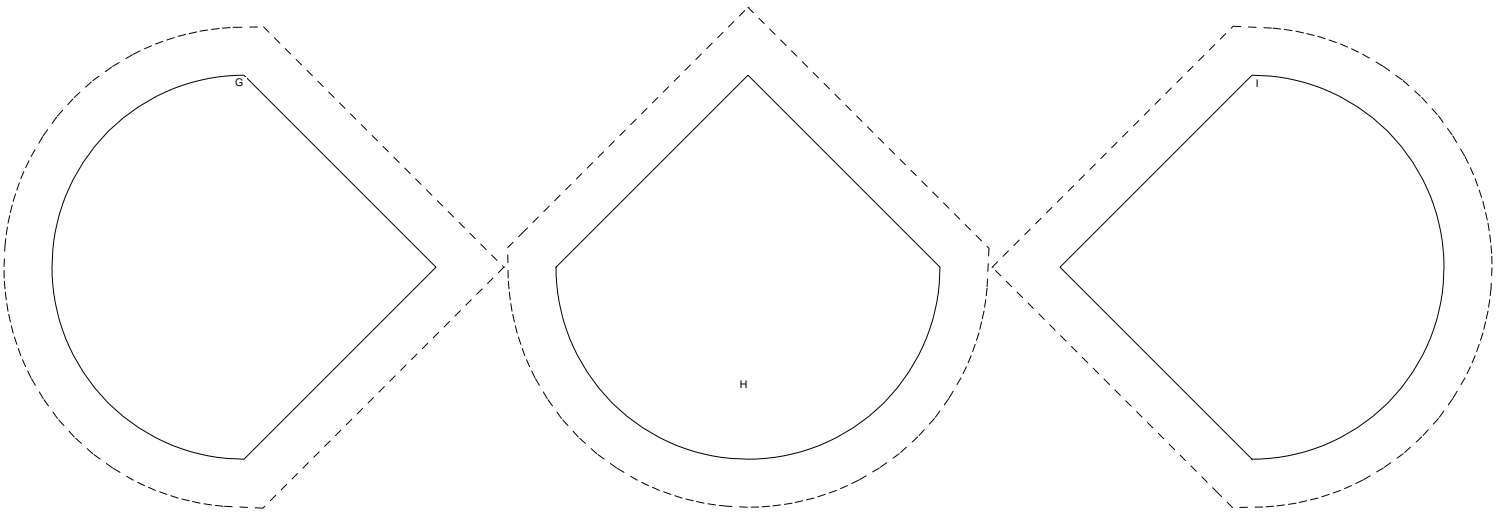
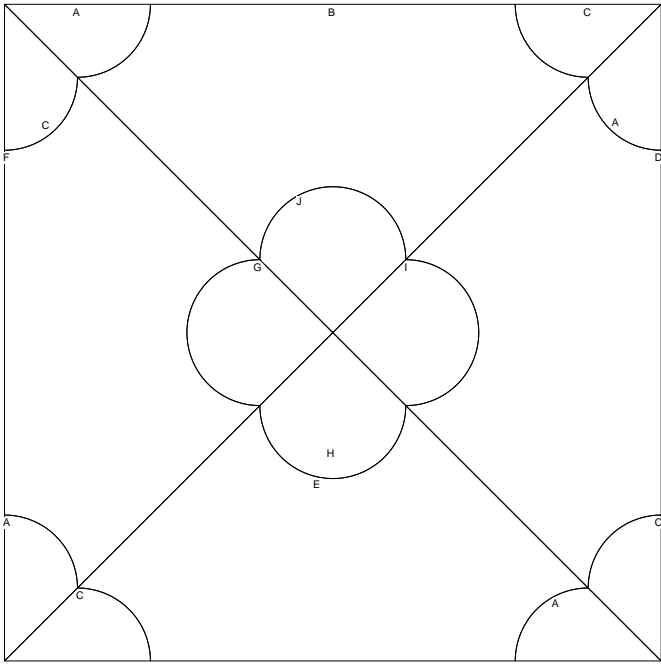

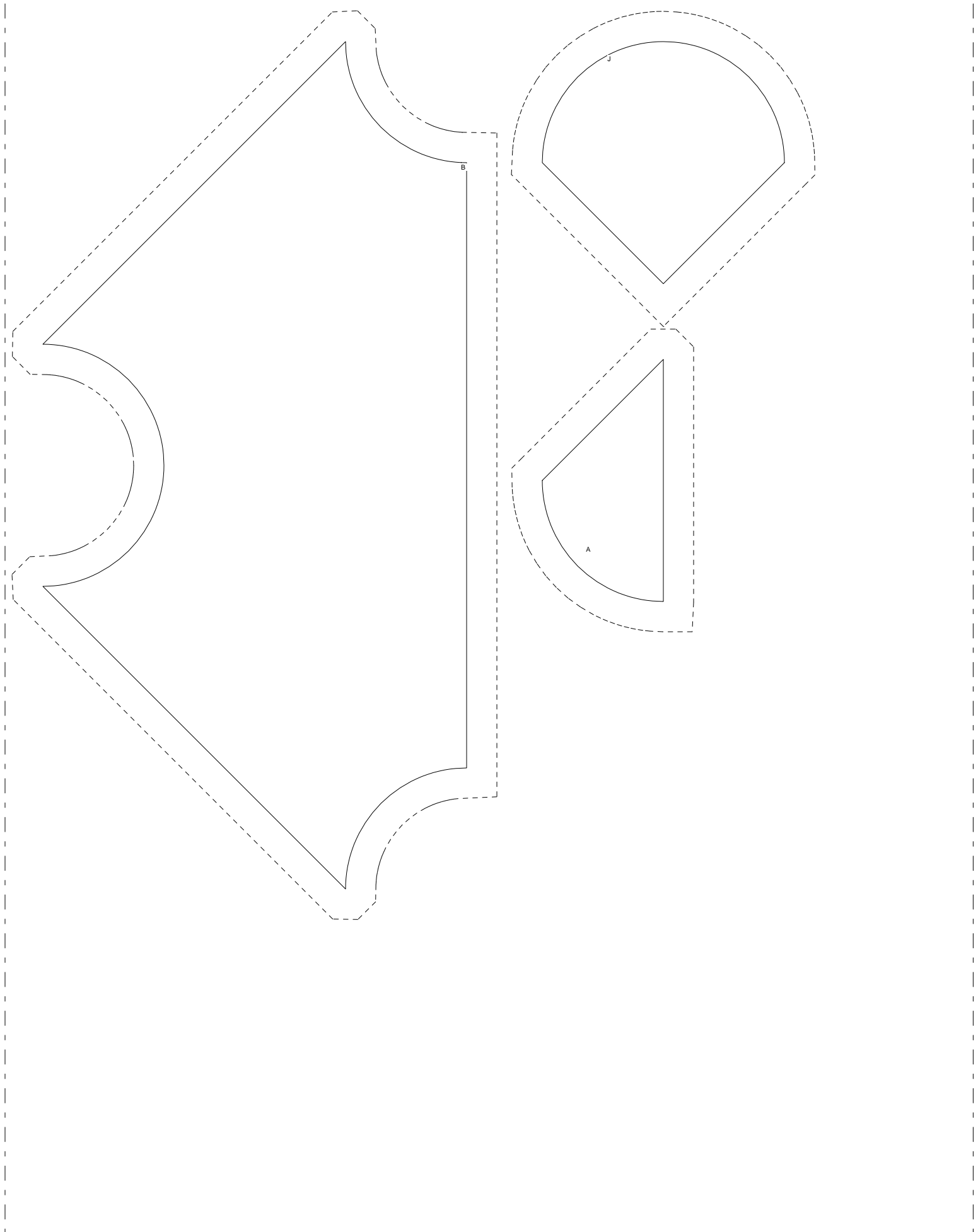

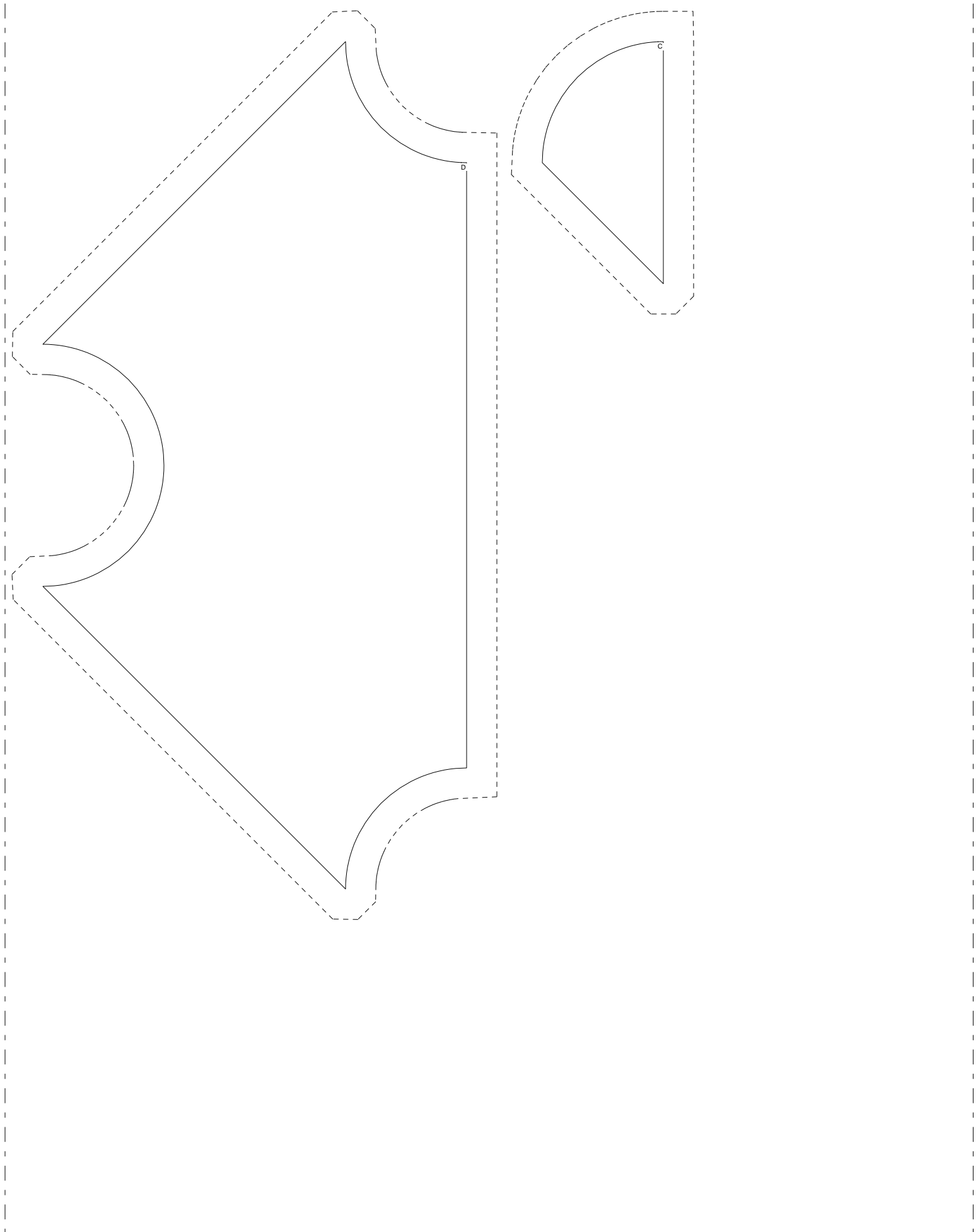

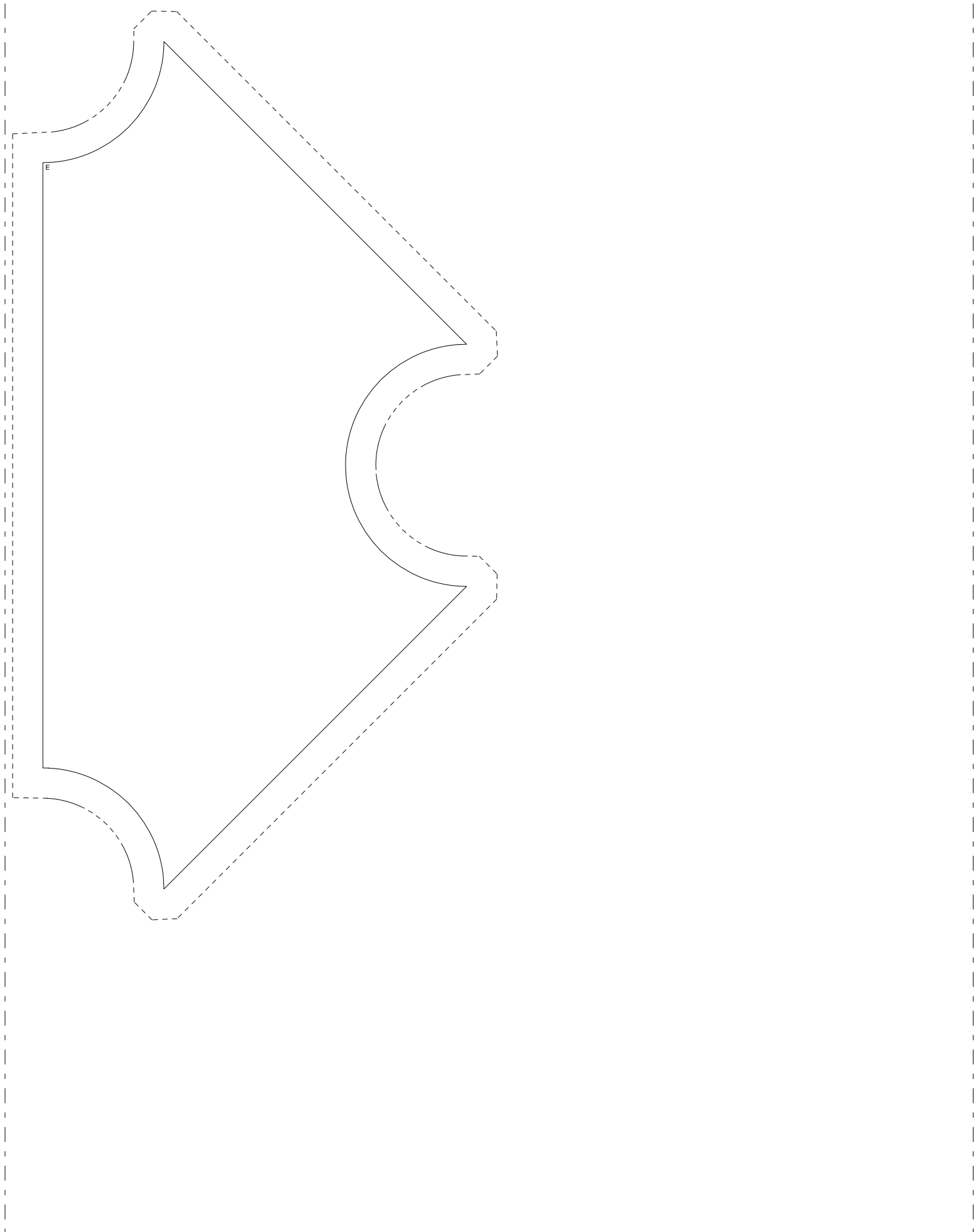

E

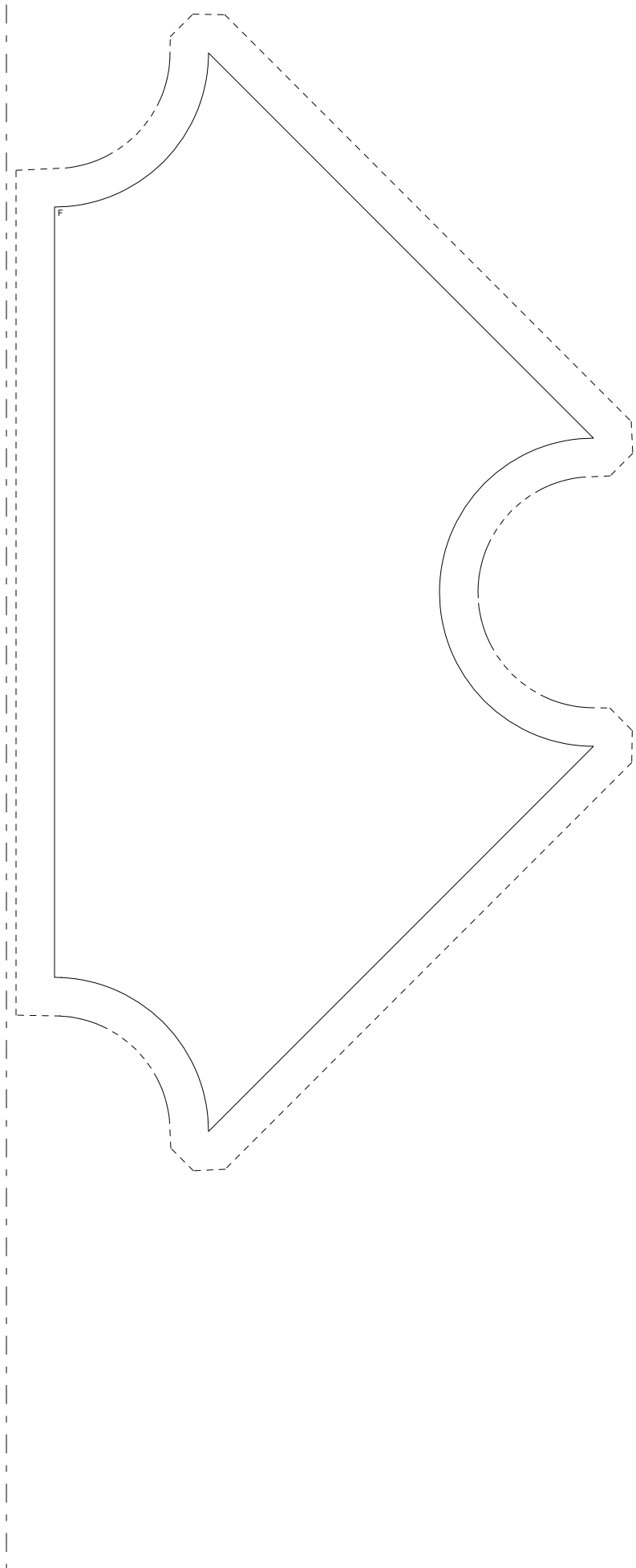

Hedgerow

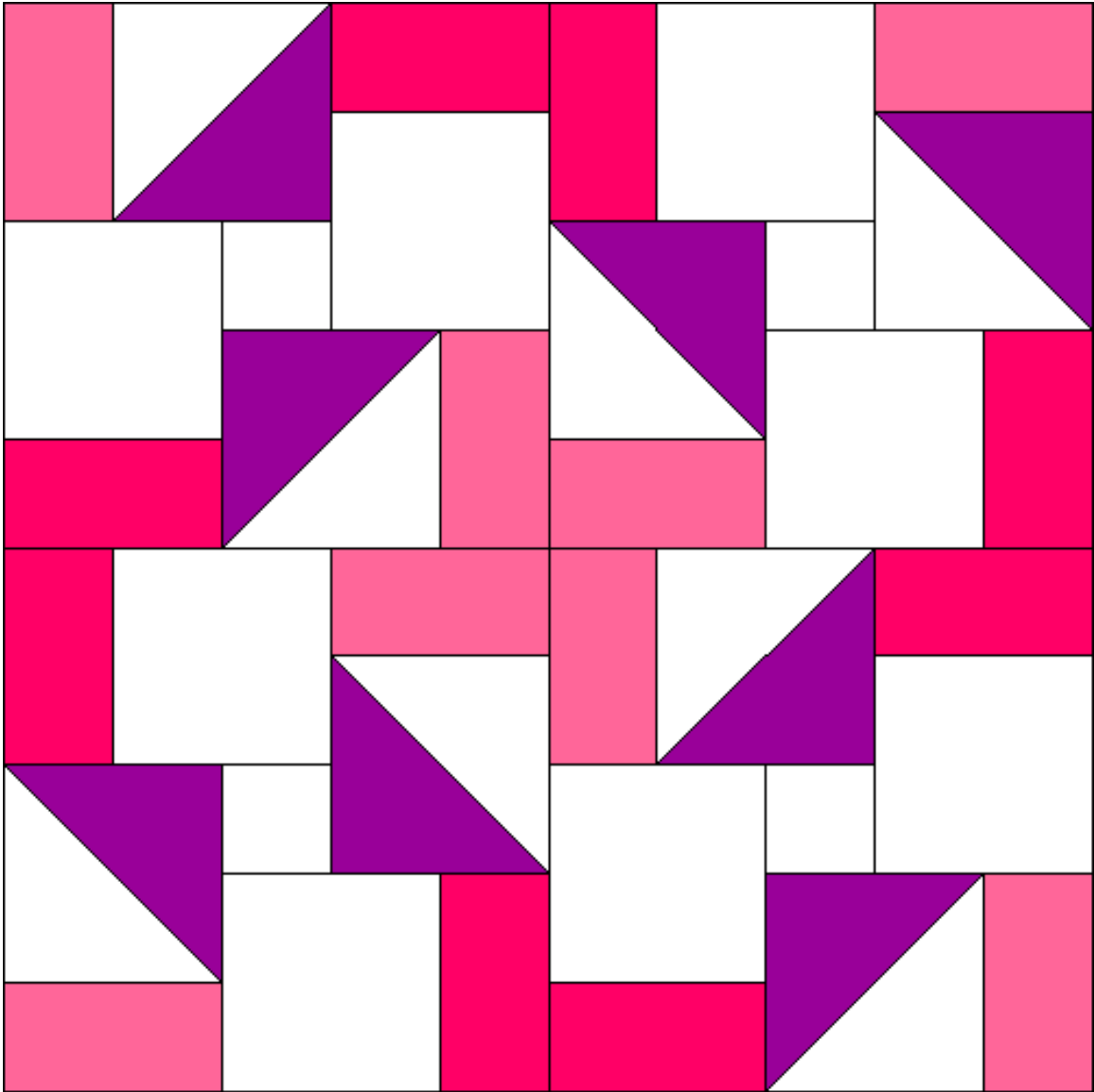

Hedgerow
Pattern for 10.00x10.00 block
Key Block (17/50 actual size)

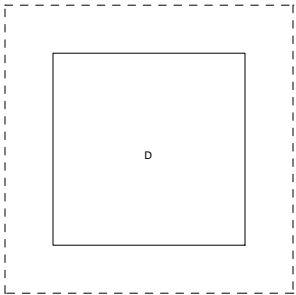
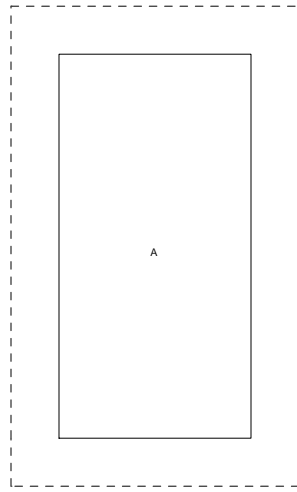
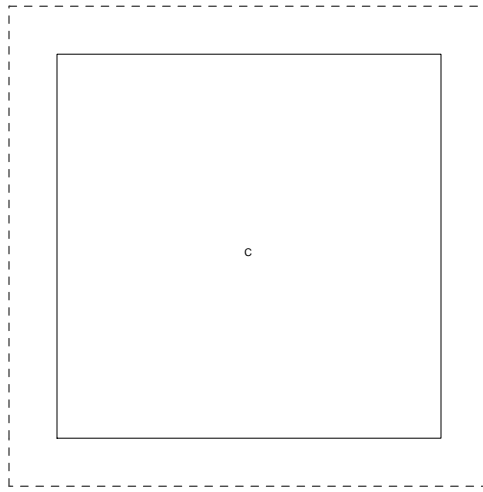
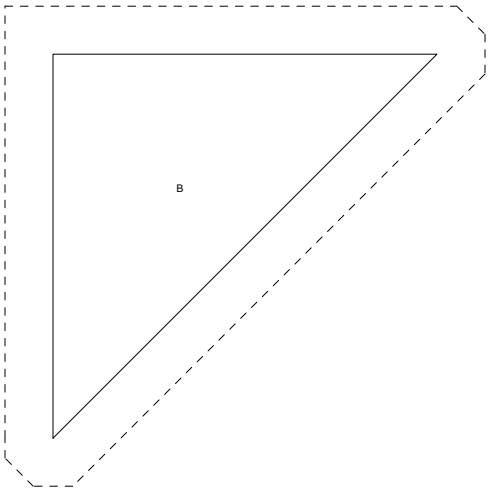
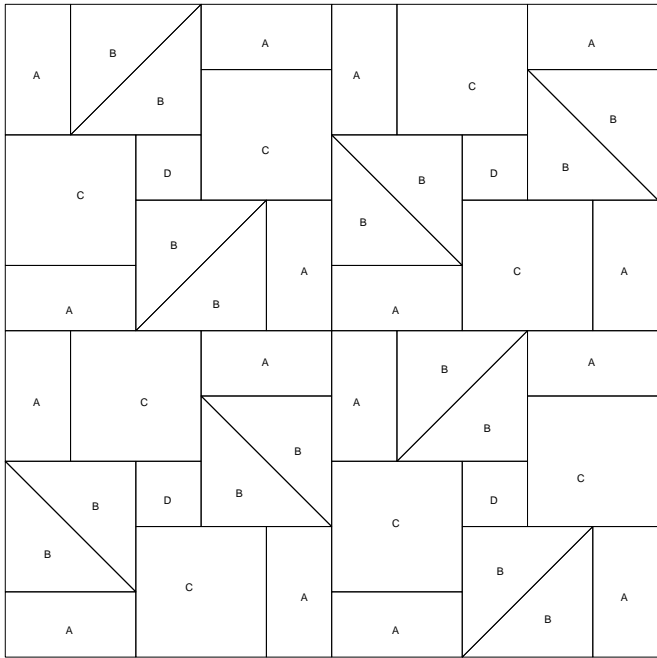

Hedgerow
 Pattern for 10.00x10.00 block
 Key Block (5/20 actual size)

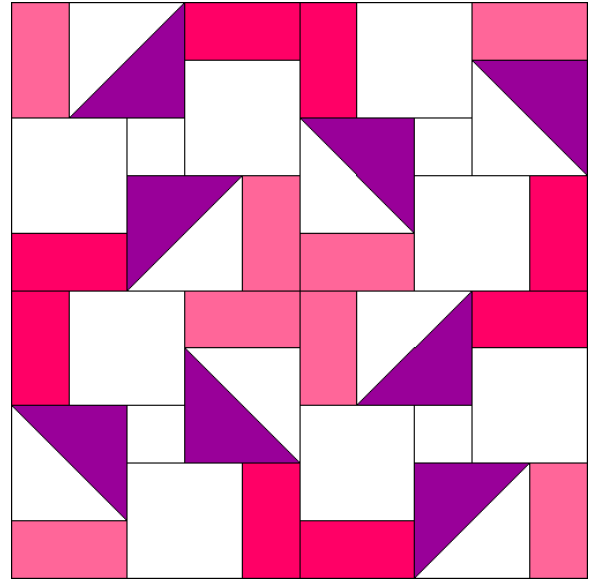
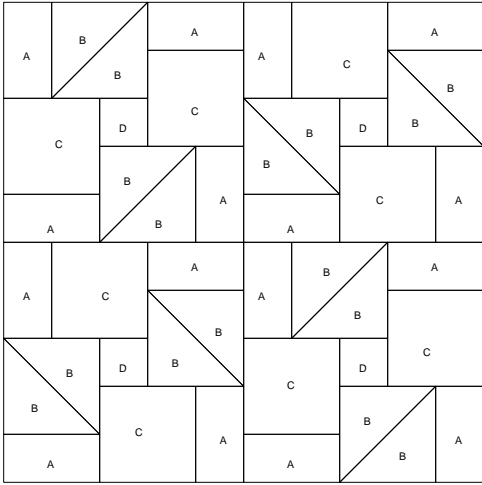

Cutting Diagrams

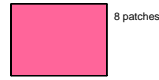
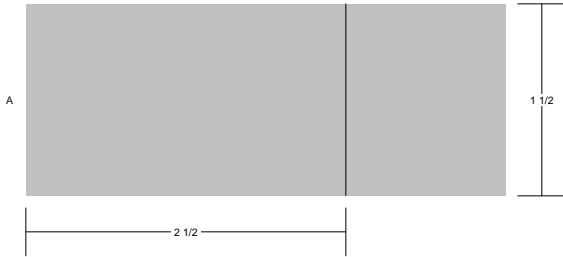

Patch Count

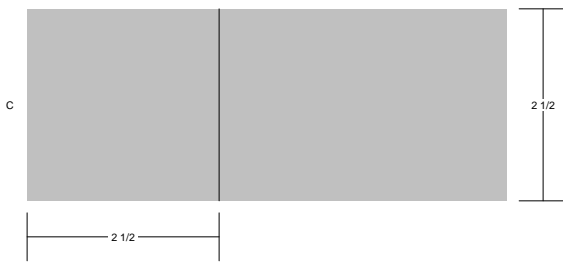
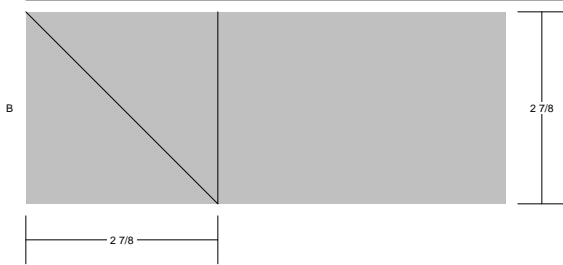
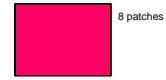



Oregon

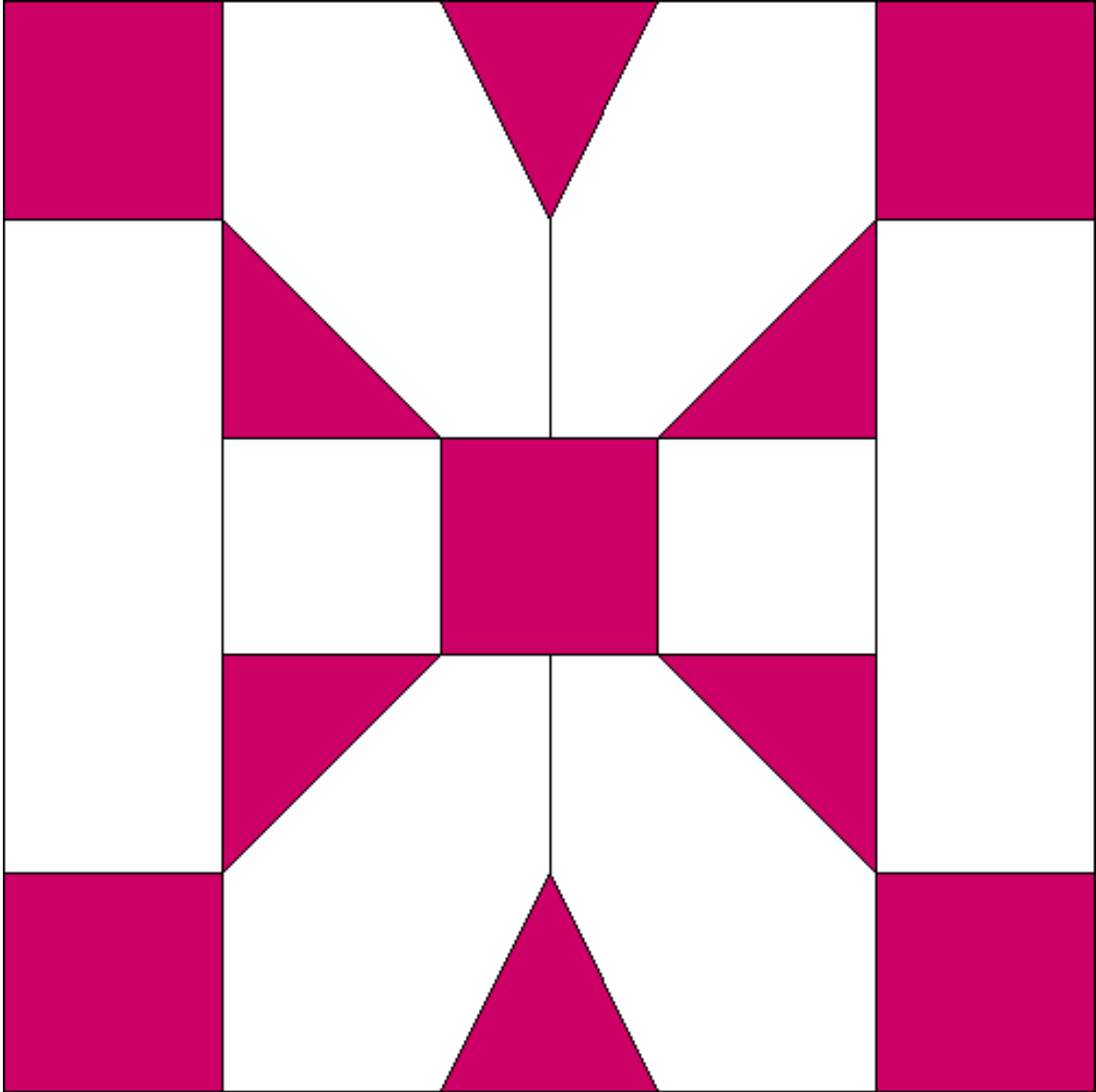

Oregon
Pattern for 10.00x10.00 block
Key Block (17/50 actual size)

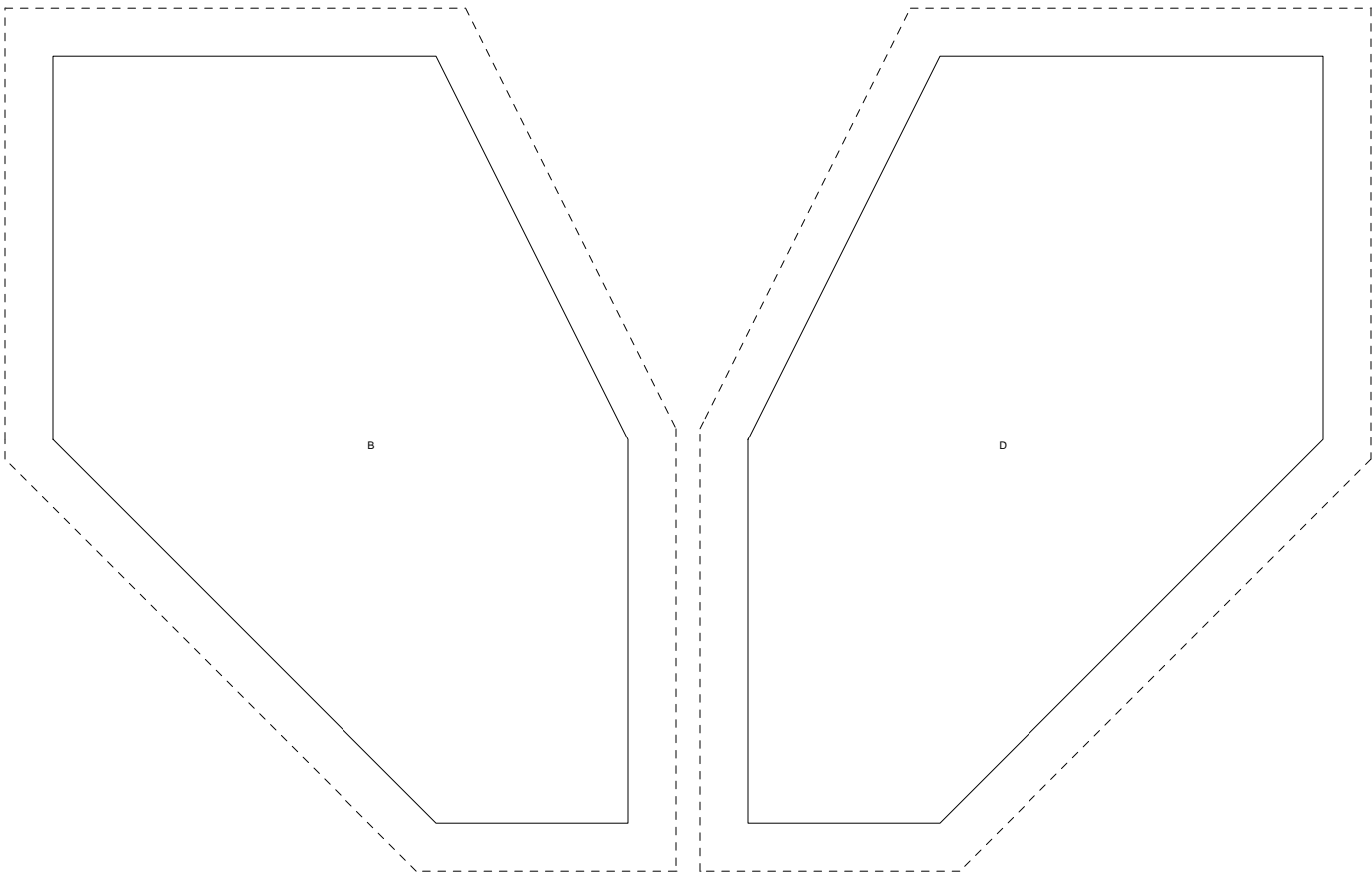
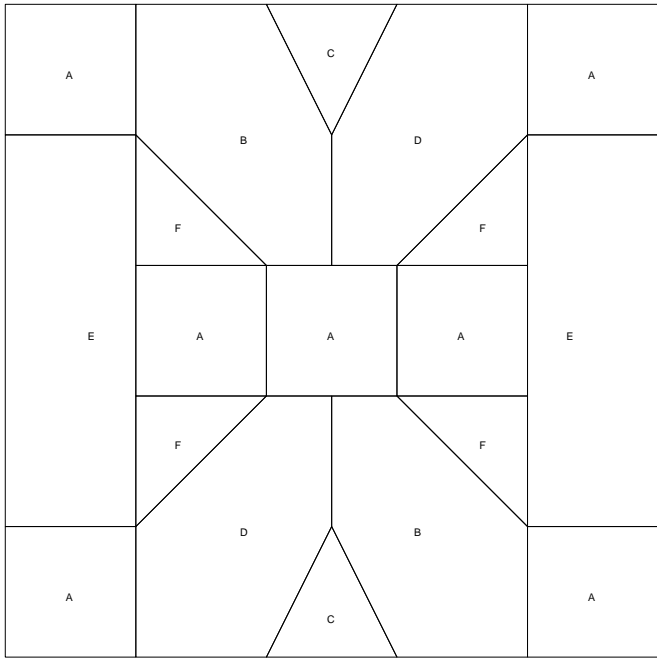

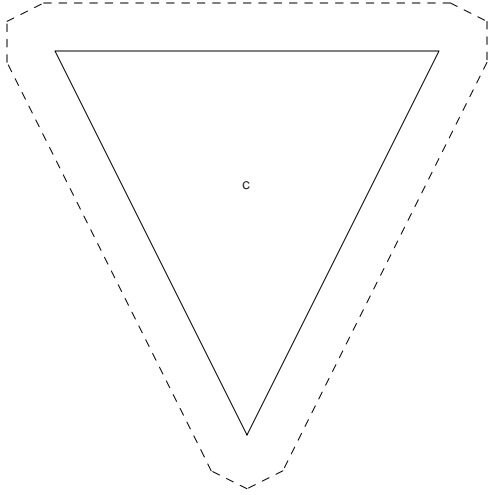
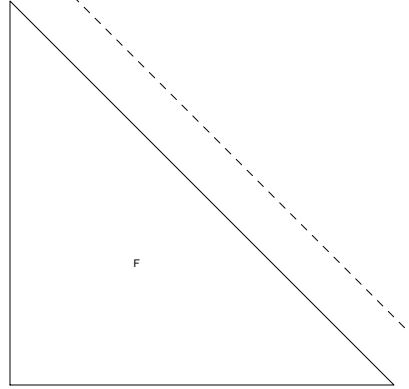
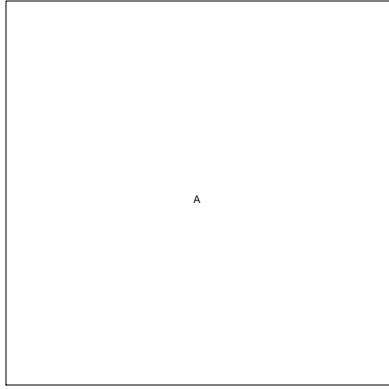
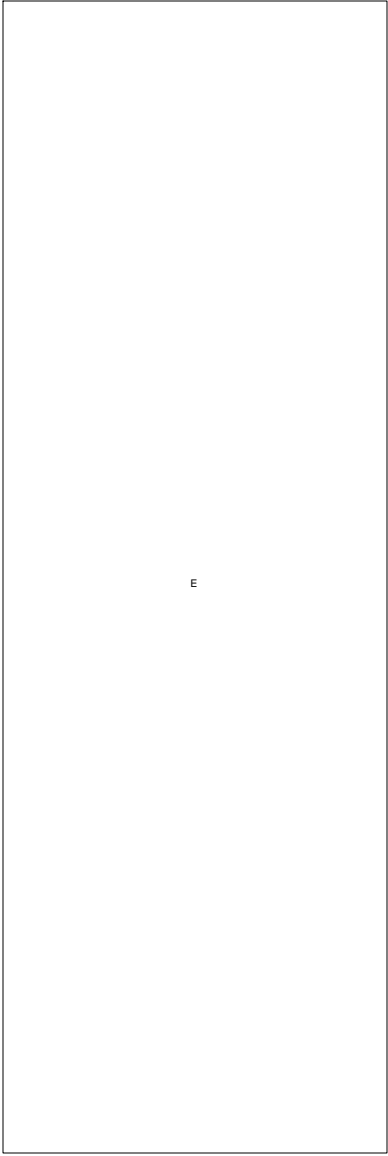

E

A

F

C

Oregon
 Pattern for 10.00x10.00 block
 Key Block (5/20 actual size)

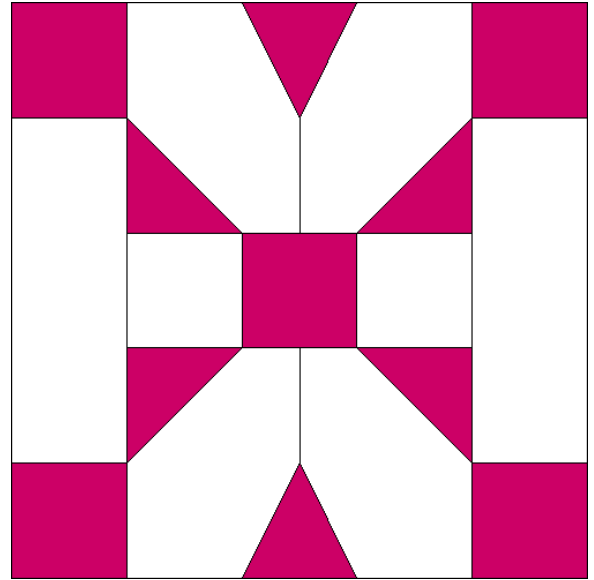
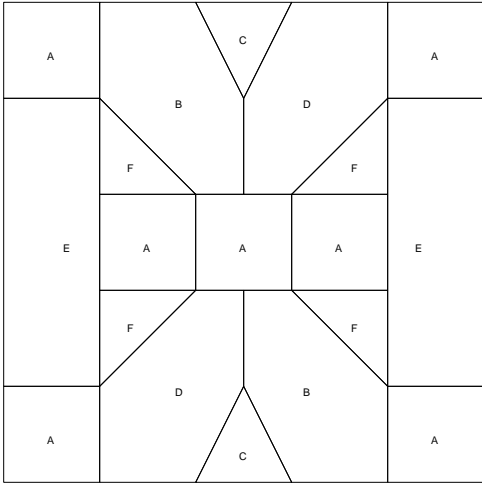

Cutting Diagrams

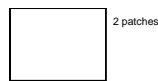
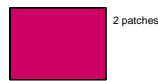
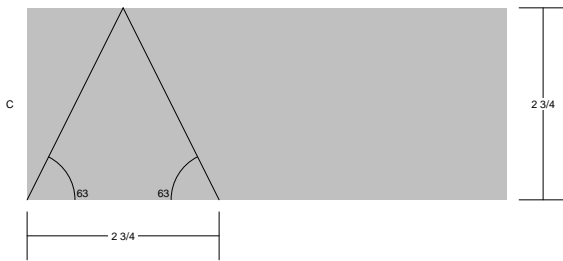
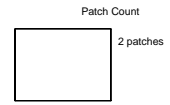

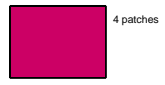
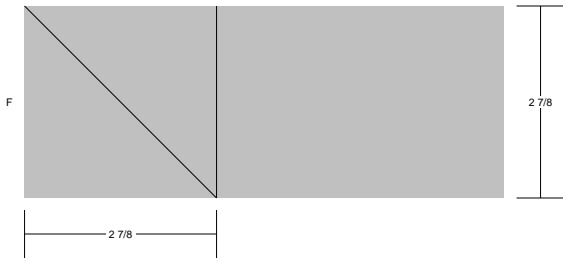

Triangle Weave

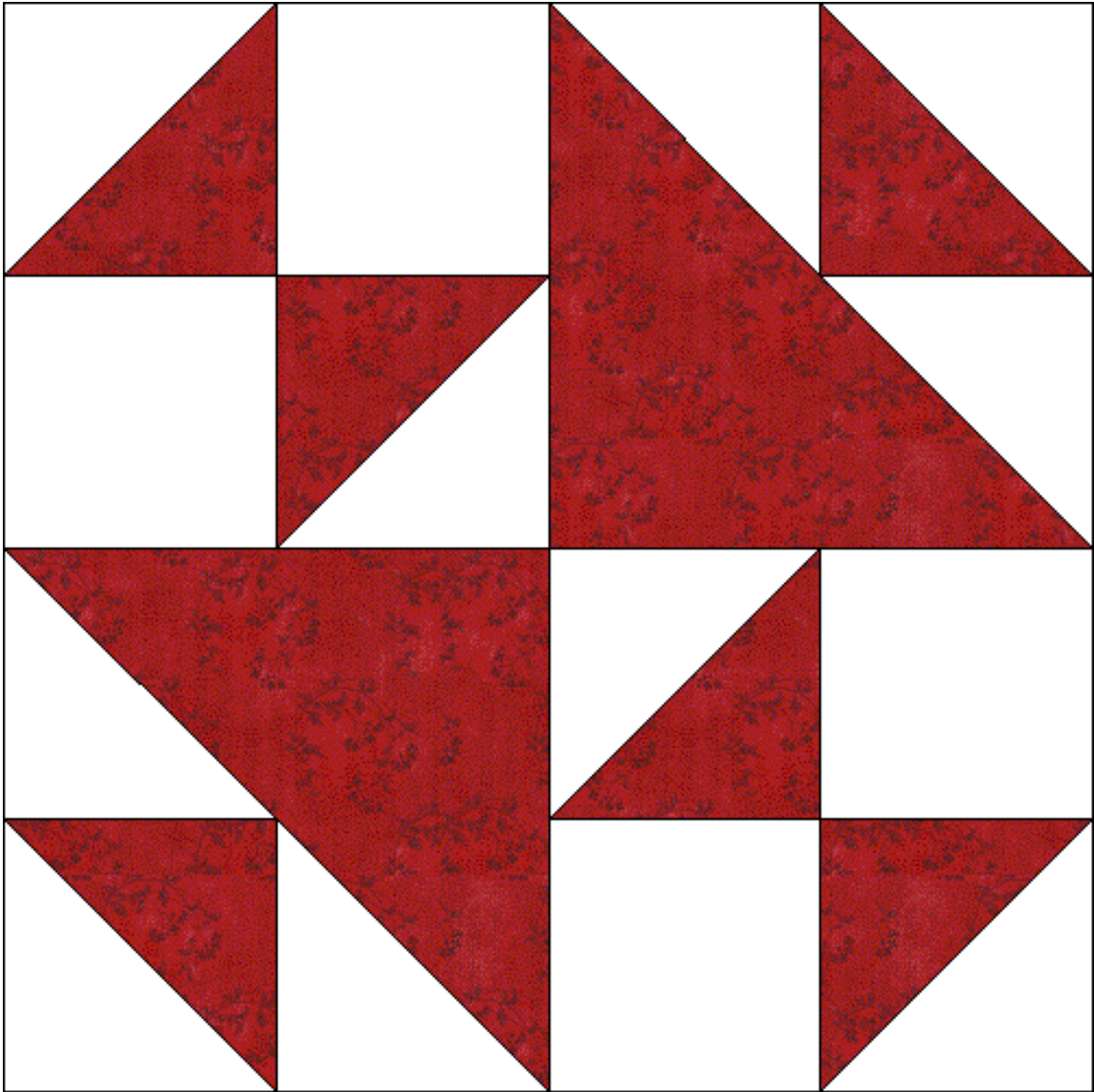

Triangle Weave
Pattern for 8.00x8.00 block
Key Block (43/100 actual size)

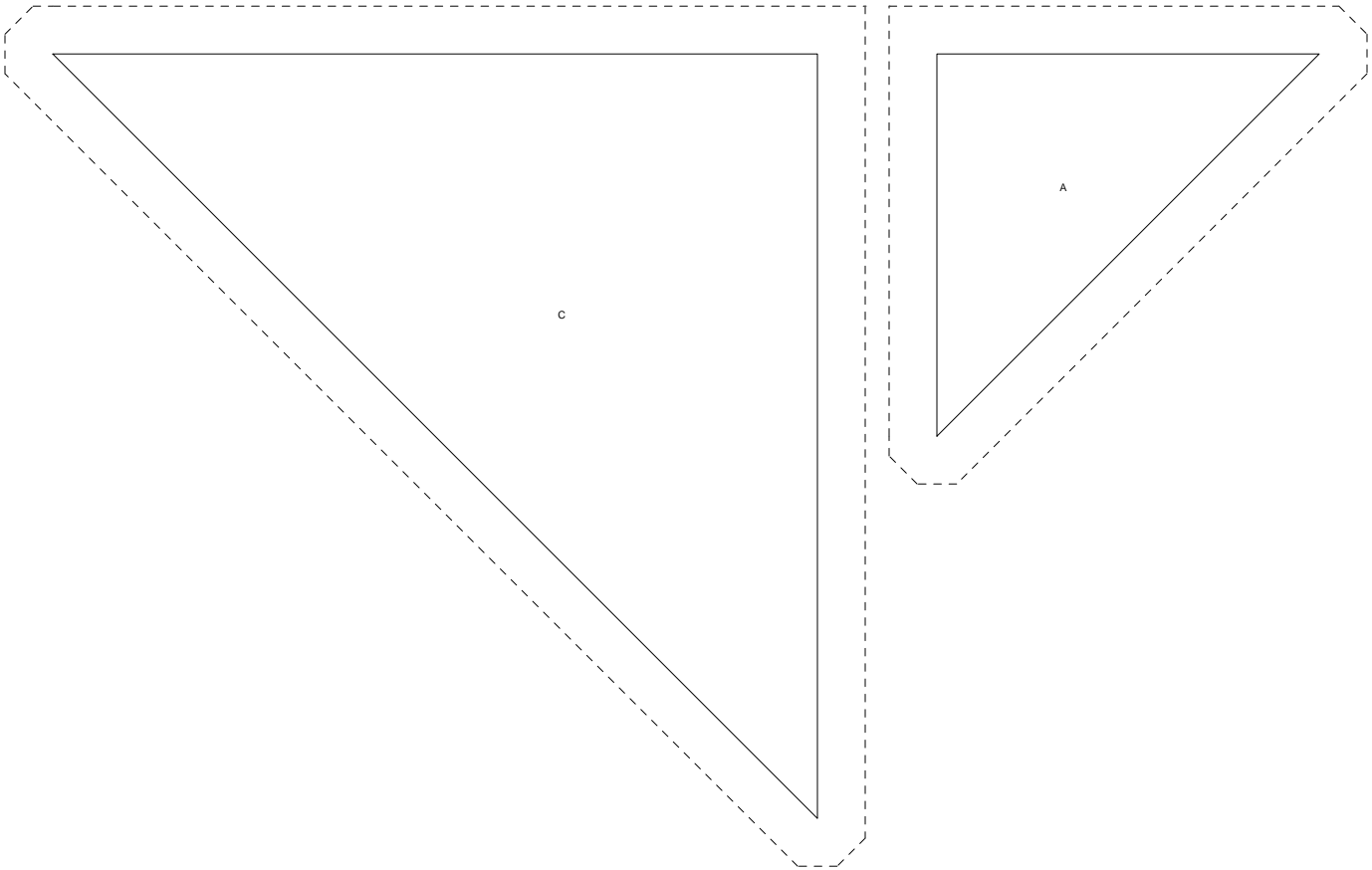
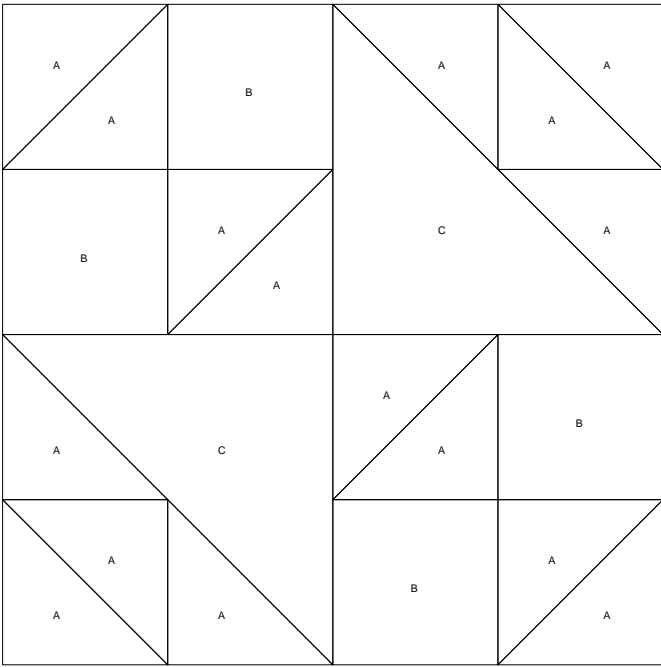

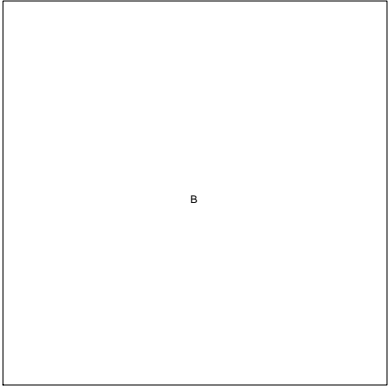

B

Triangle Weave
 Pattern for 8.00x8.00 block
 Key Block (31/100 actual size)

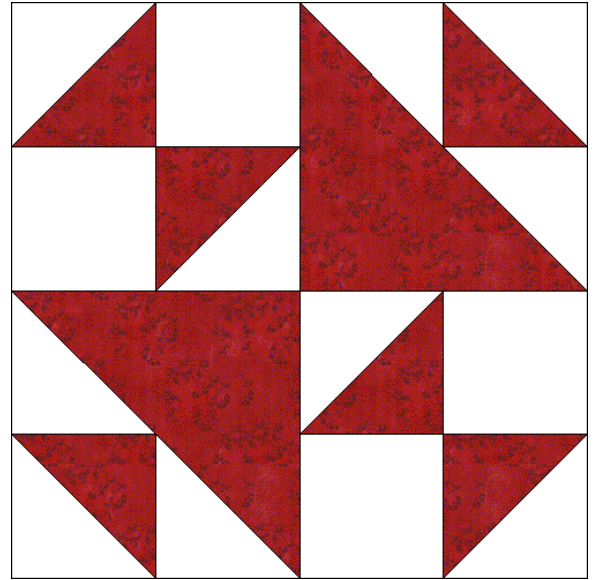
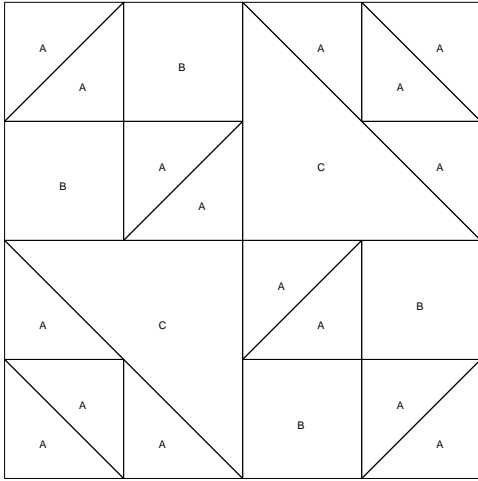

Cutting Diagrams

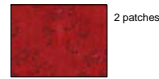
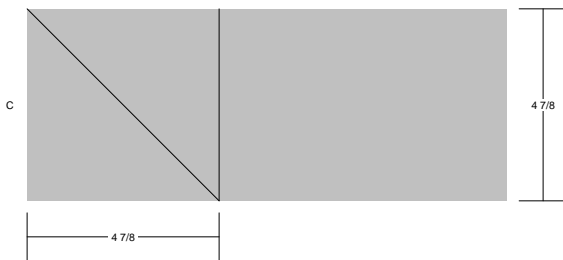
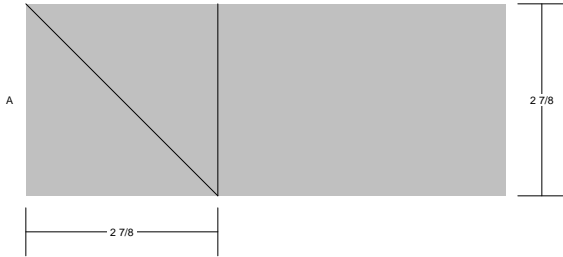

Tulip Lady Fingers

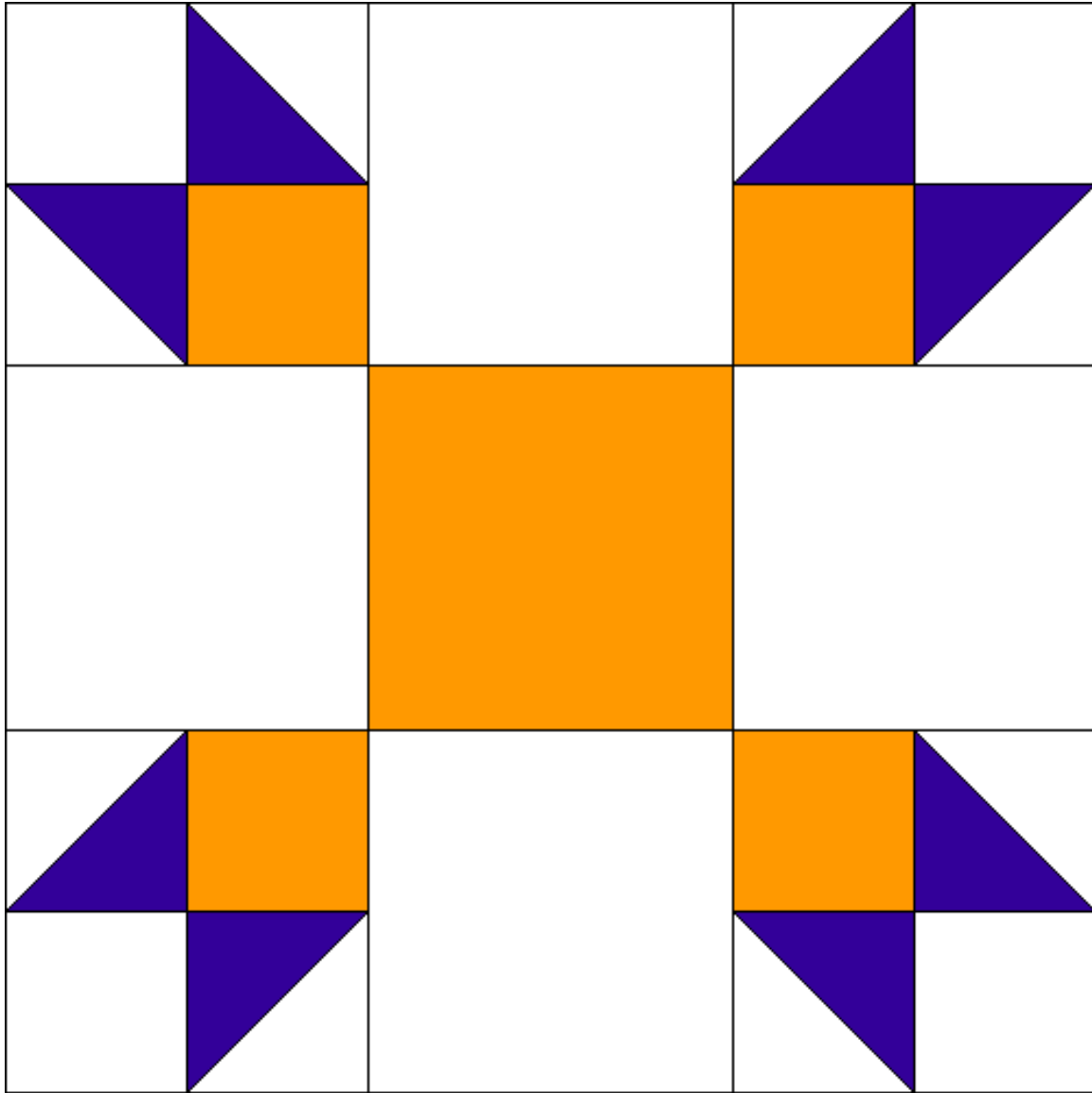

Tulip Lady Fingers
Pattern for 9.00x9.00 block
Key Block (19/50 actual size)

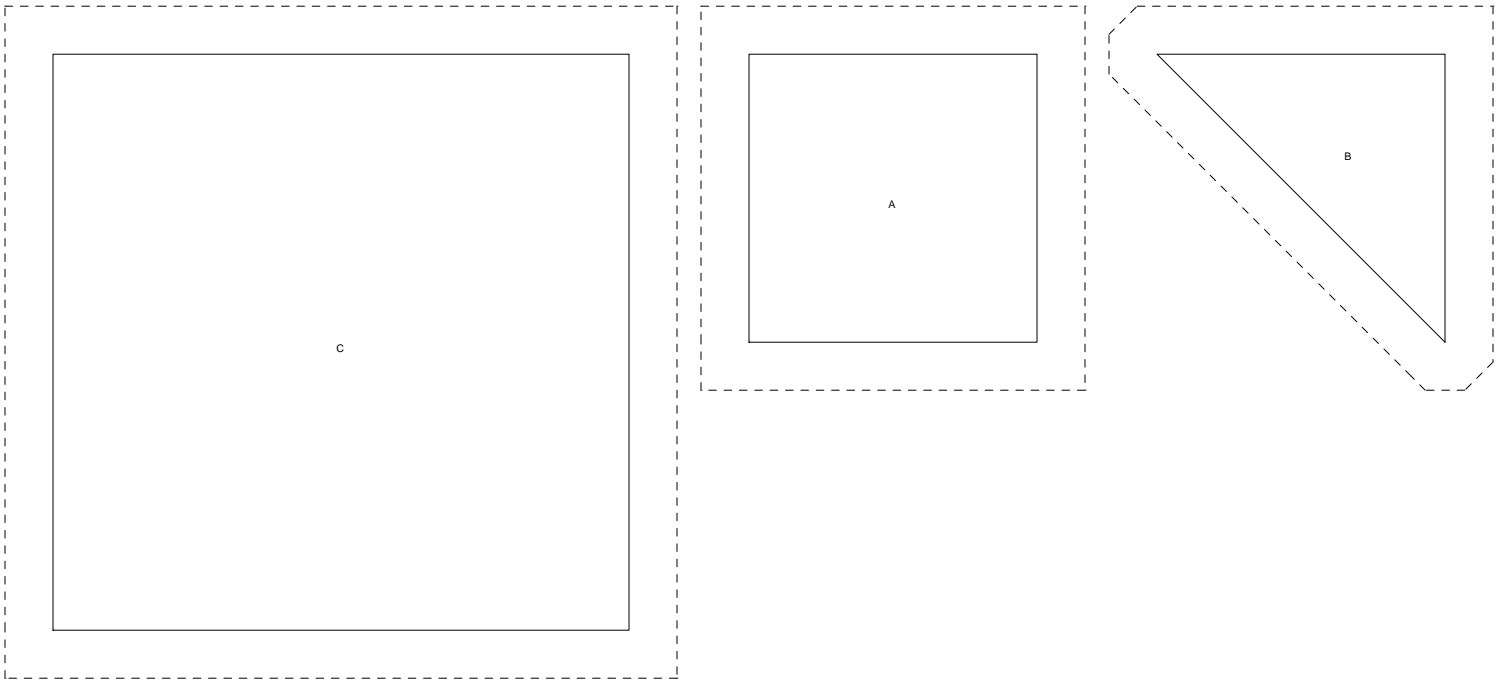
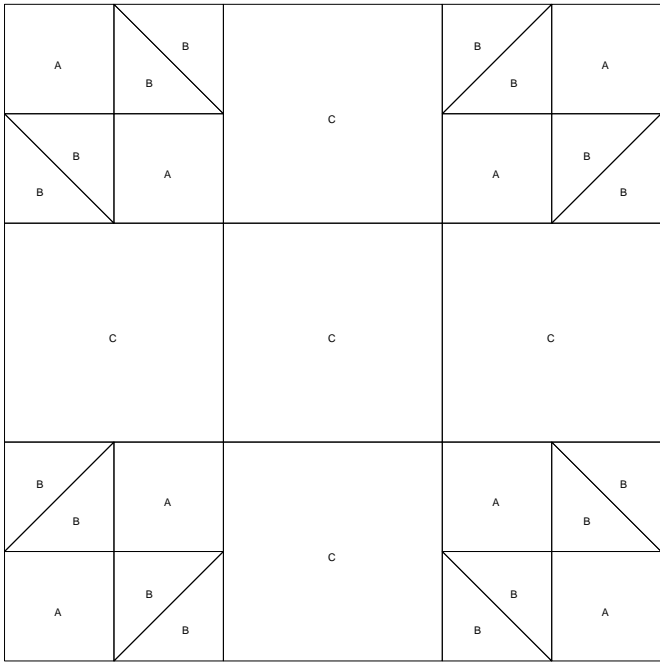

Tulip Lady Fingers
 Pattern for 9.00x9.00 block
 Key Block (27/100 actual size)

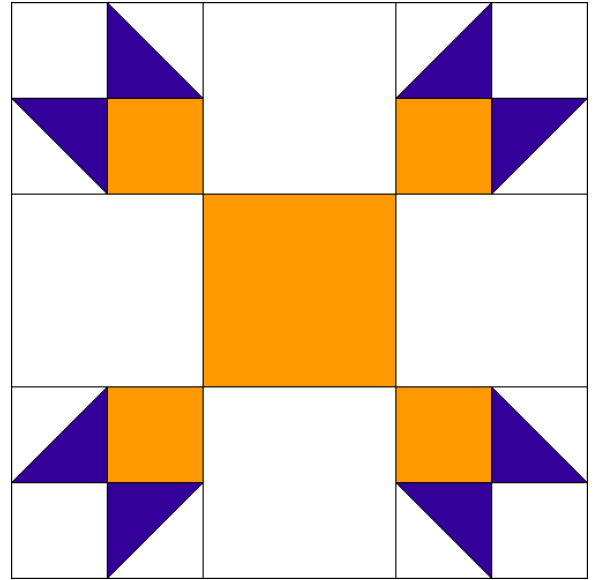
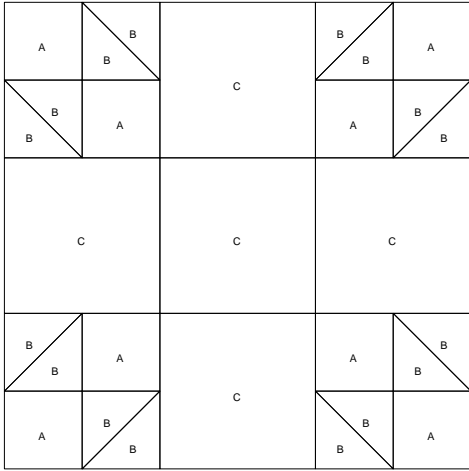

Cutting Diagrams

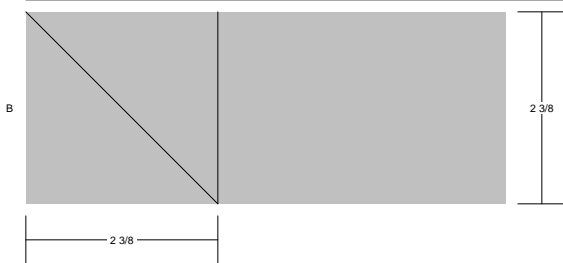
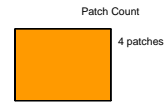

Wishing Ring

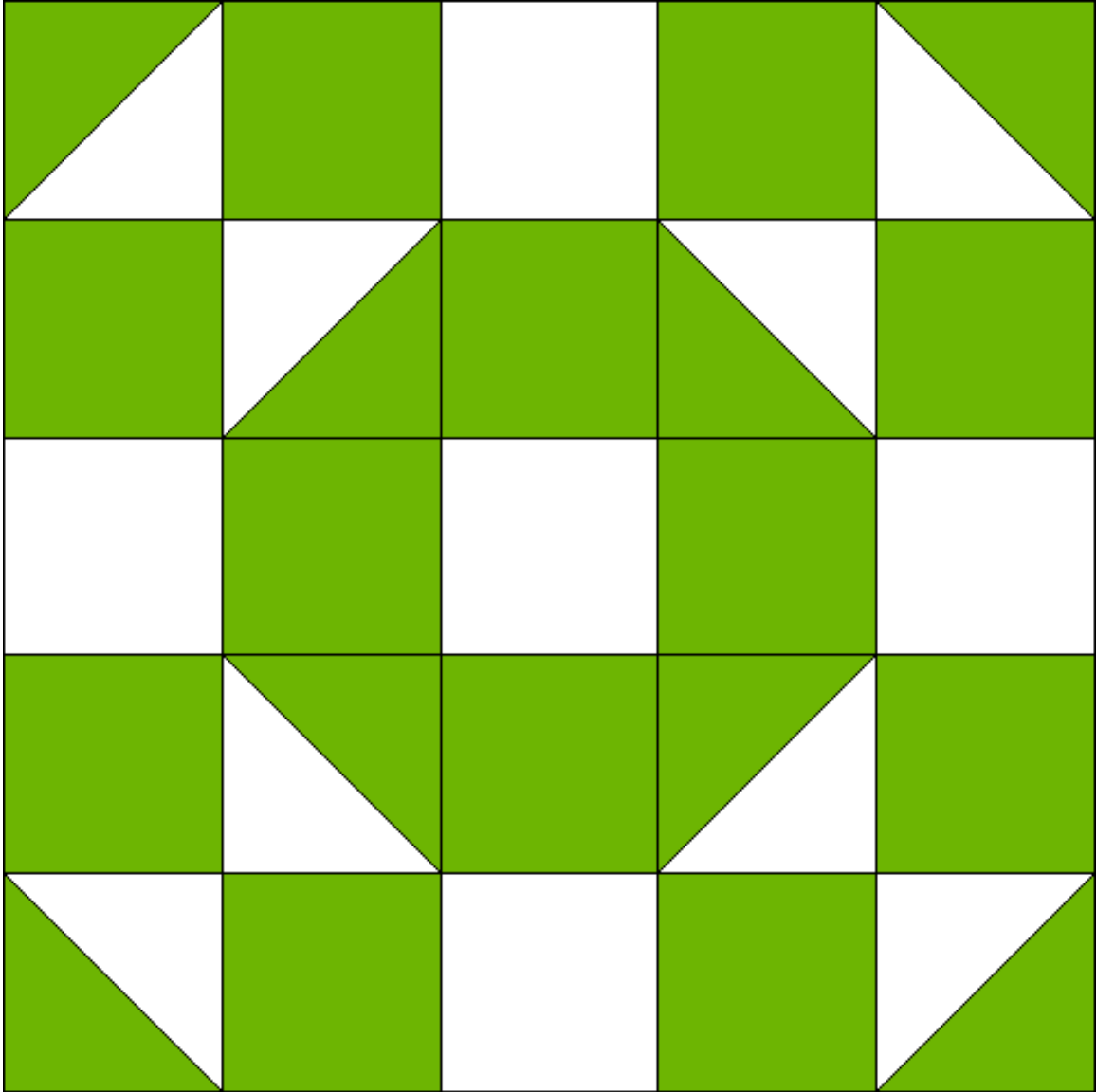

Wishing Ring
Pattern for 10.00x10.00 block
Key Block (17/50 actual size)

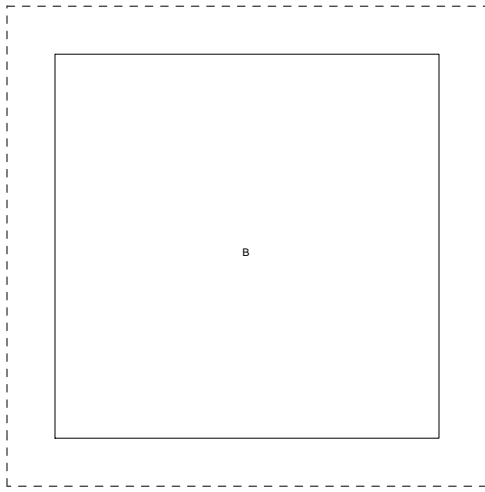
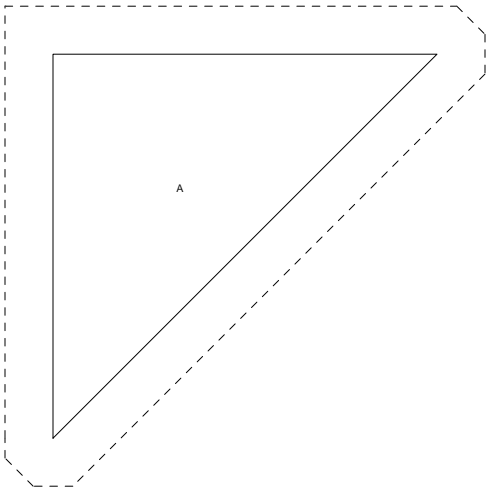
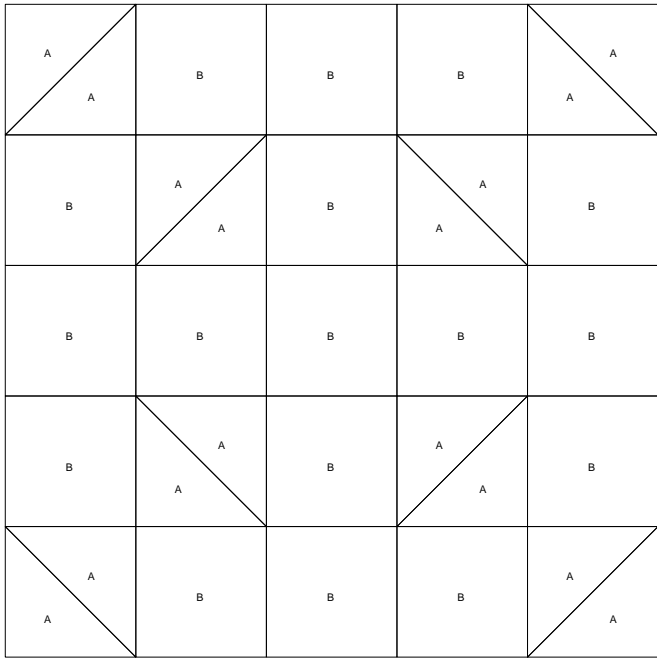

Wishing Ring
 Pattern for 10.00x10.00 block
 Key Block (5/20 actual size)

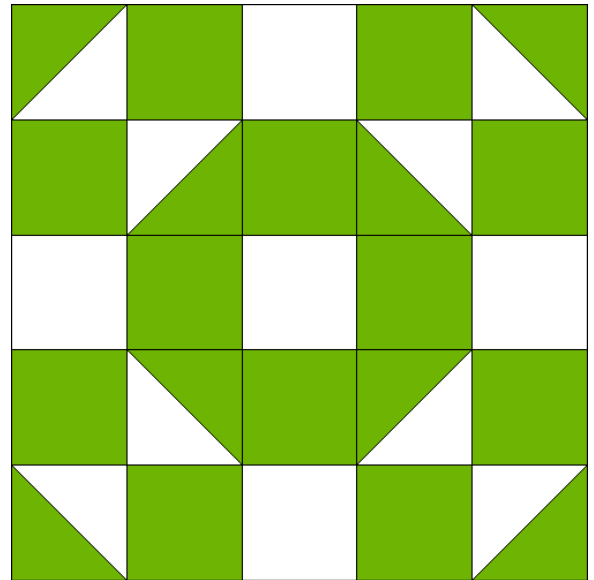
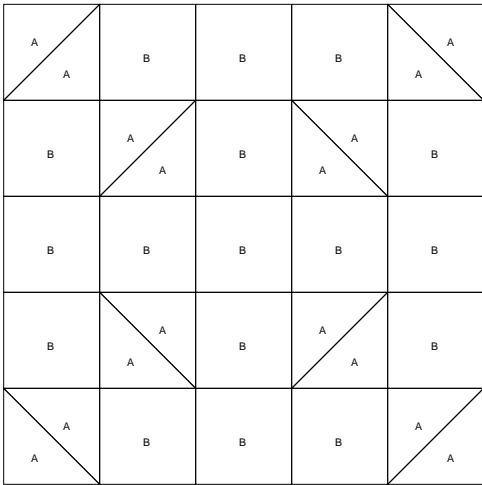

Cutting Diagrams

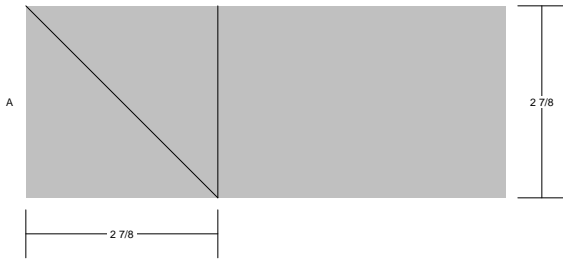

Patch Count

