

# September How To Quilt Patterns

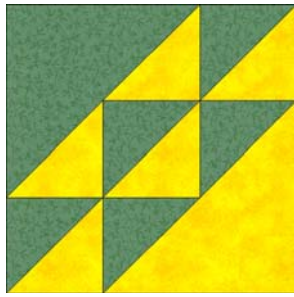

Corn and Beans

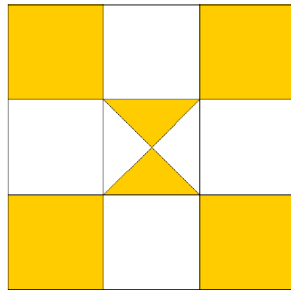

Practical Orchard

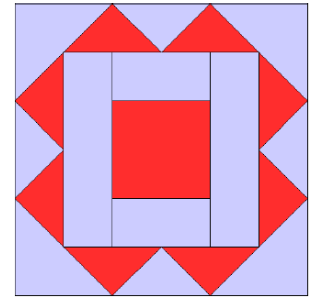

Prairie Home

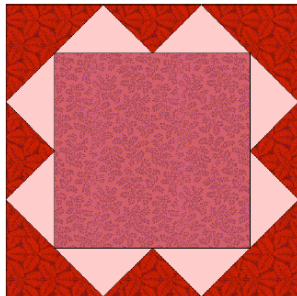

Country Farm

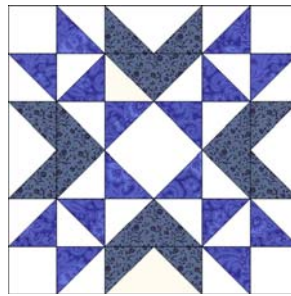

Wyoming Valley

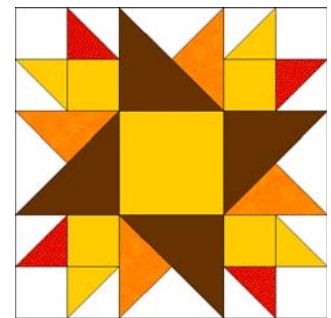

Sunflower

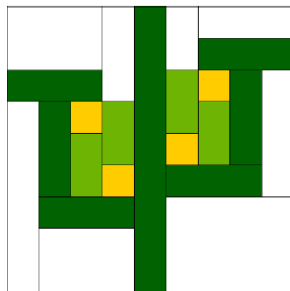

Missouri Corn Field



Bridle Path

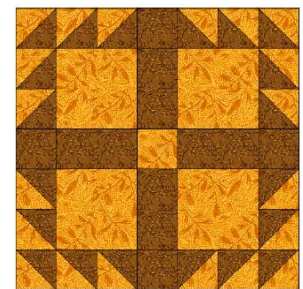

Hens and Chickens

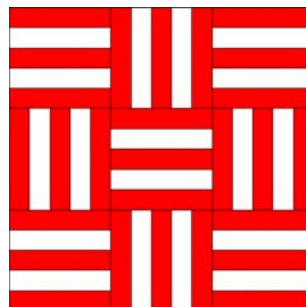

Colt's Corral

# Bridle Path

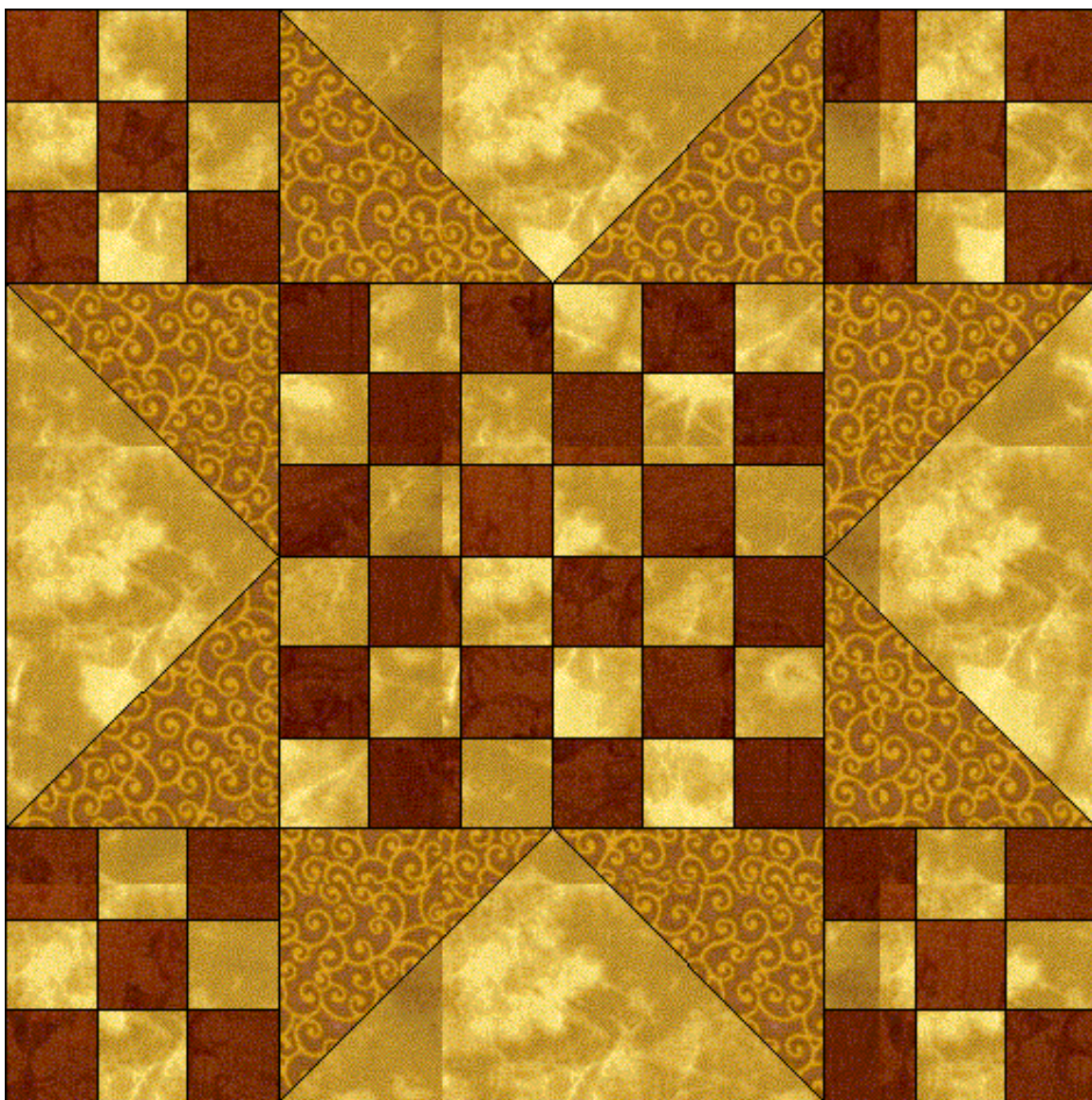

# Bridle Path

Pattern for 12.00x12.00 block  
Key Block (29/100 actual size)

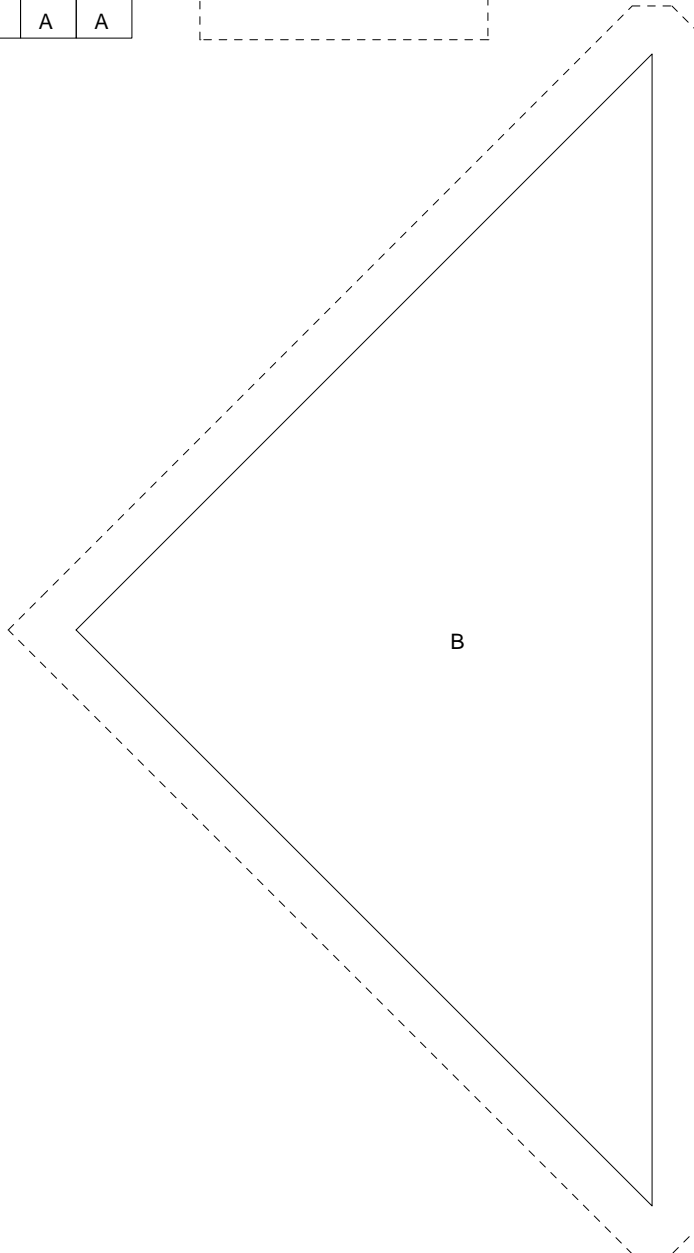
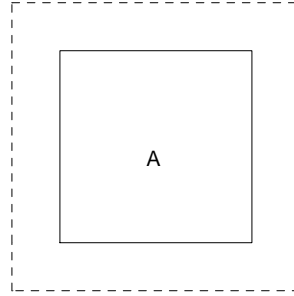
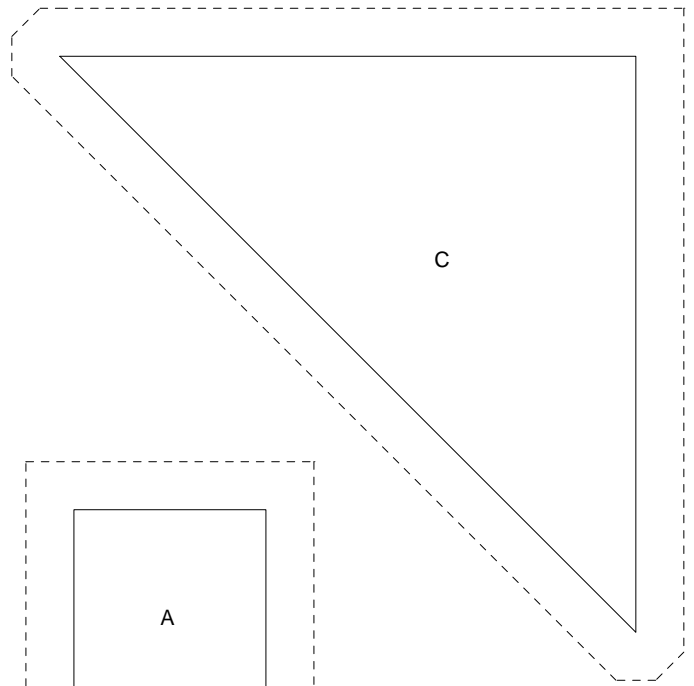
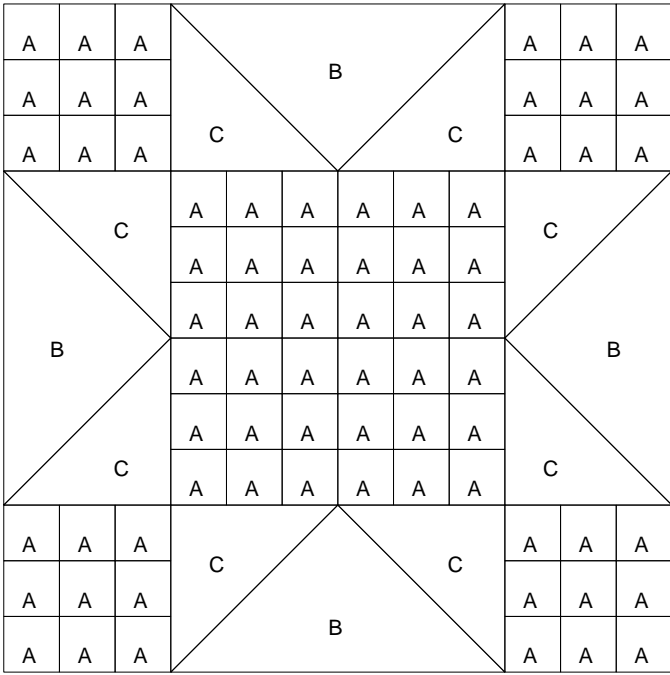

# Bridle Path

Pattern for 12.00x12.00 block  
Key Block (1/5 actual size)

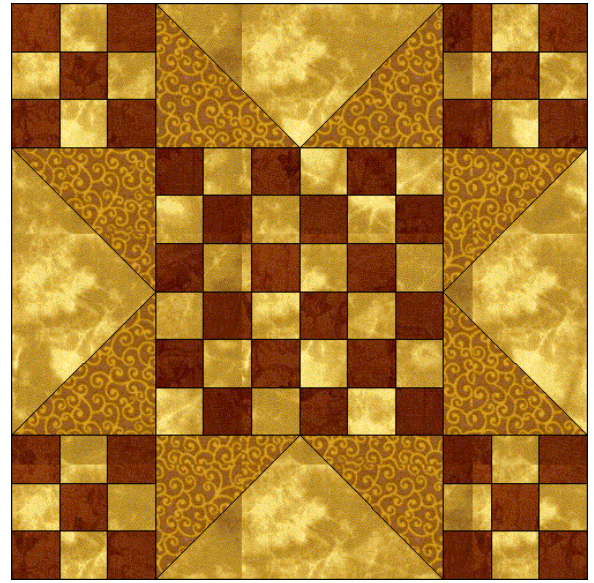
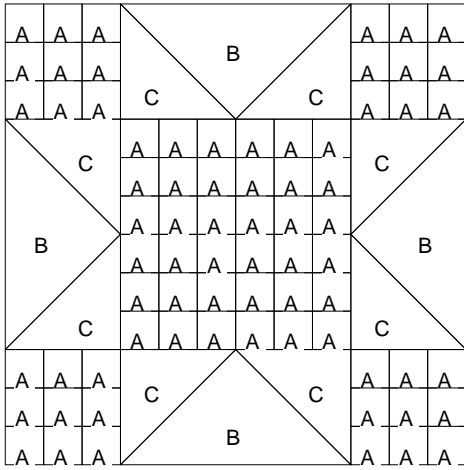

## Cutting Diagrams

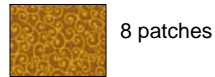
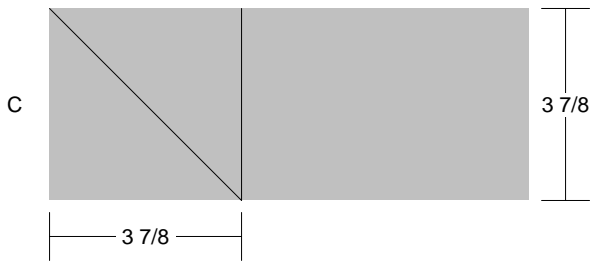
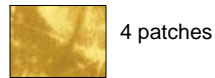
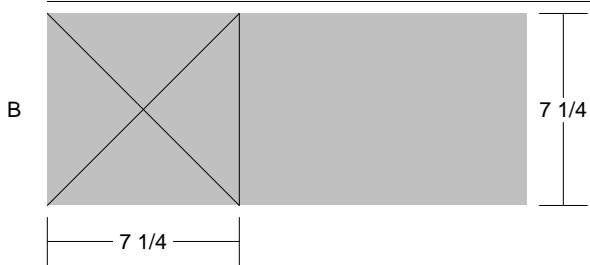
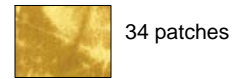

# Colt's Corral

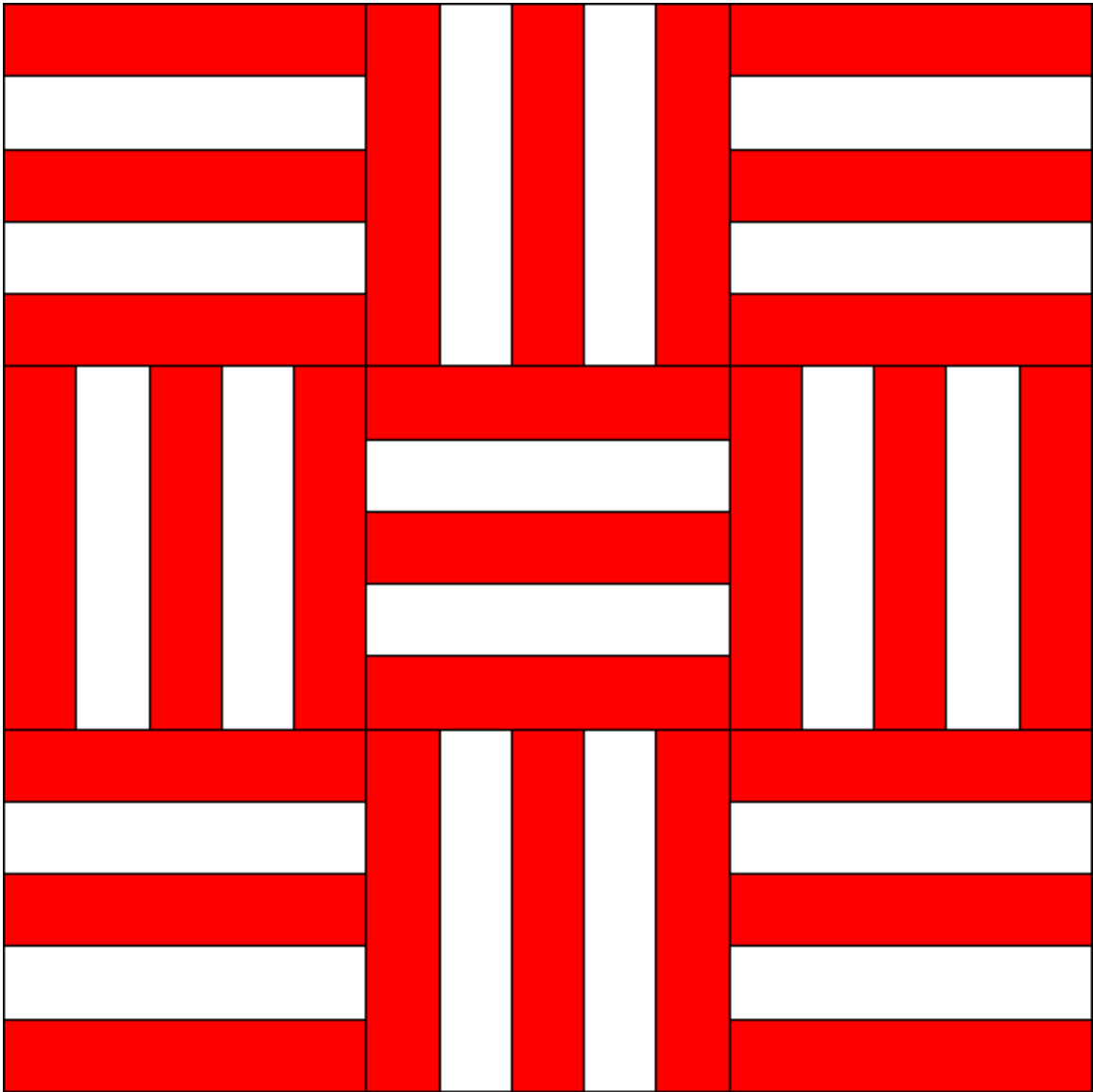

# Colt's Corral

Pattern for 15.00x15.00 block  
Key Block (23/100 actual size)

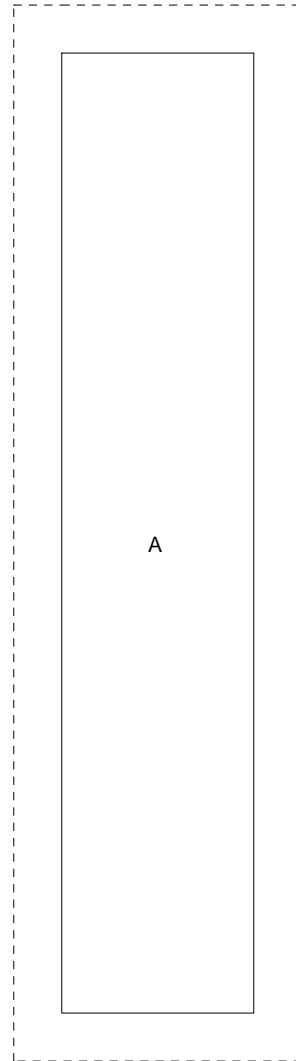
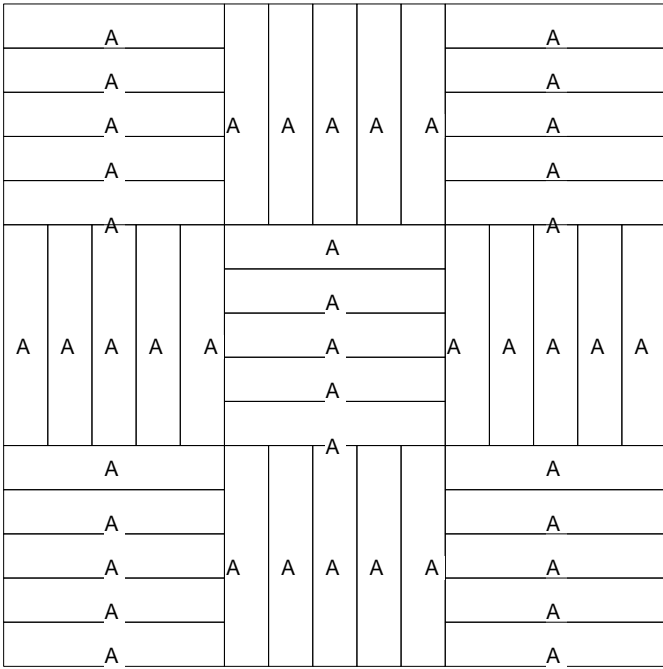

# Colt's Corral

Pattern for 15.00x15.00 block  
Key Block (8/50 actual size)

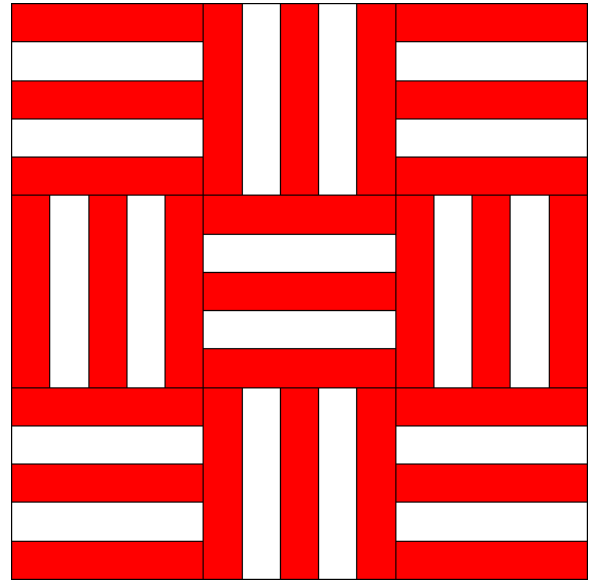
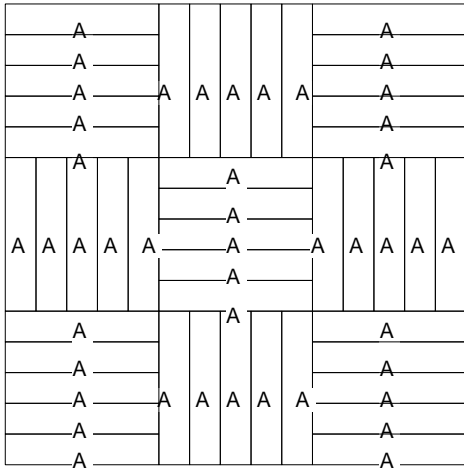

## Cutting Diagrams

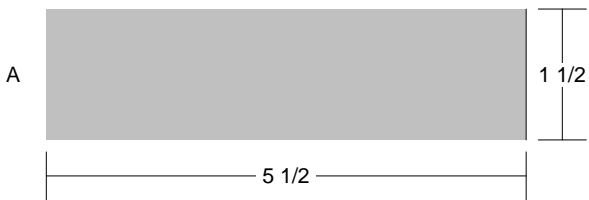

## Patch Count



27 patches



18 patches

# Corn and Beans

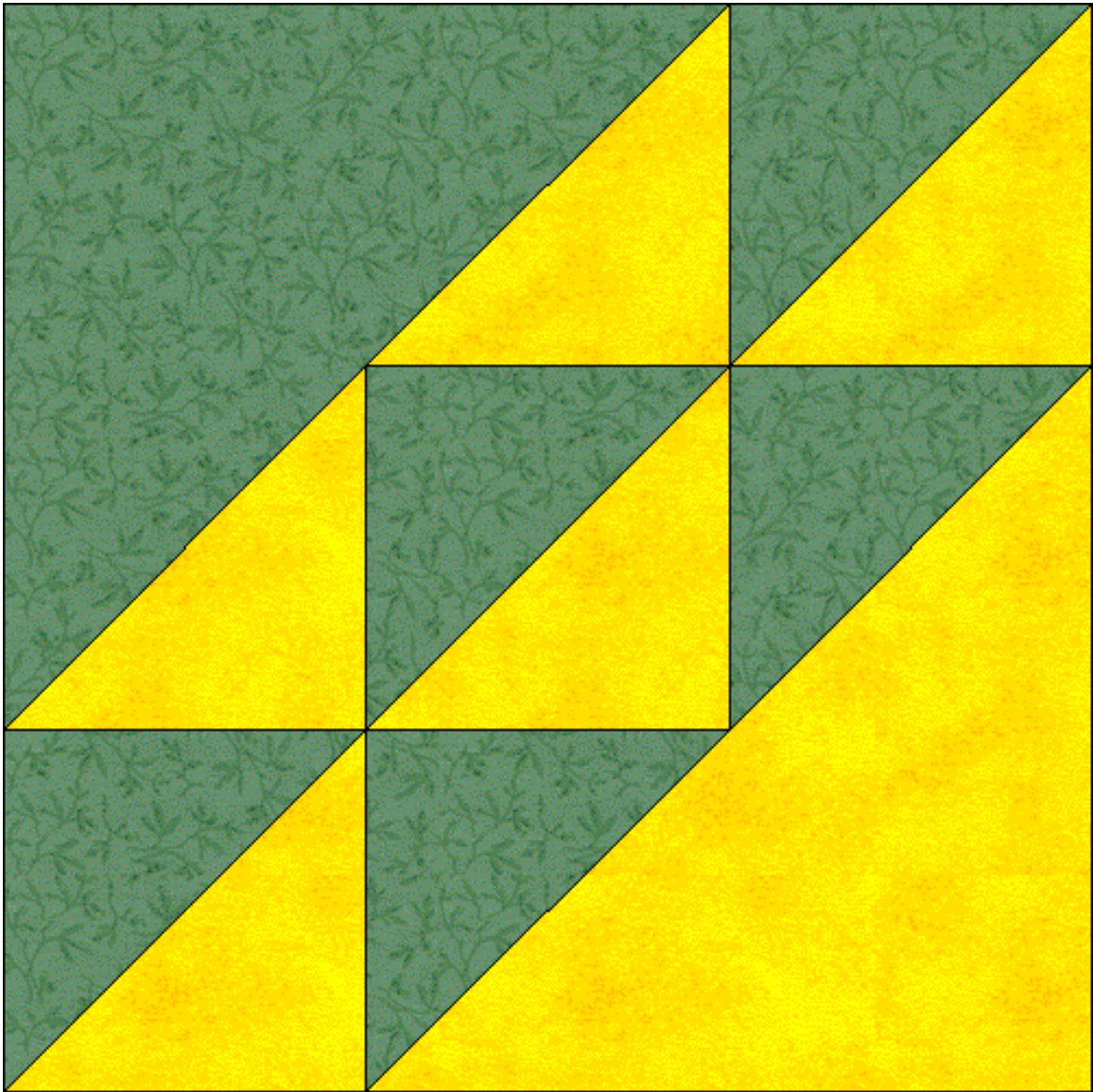

# Corn and Beans

Pattern for 12.00x12.00 block  
Key Block (29/100 actual size)

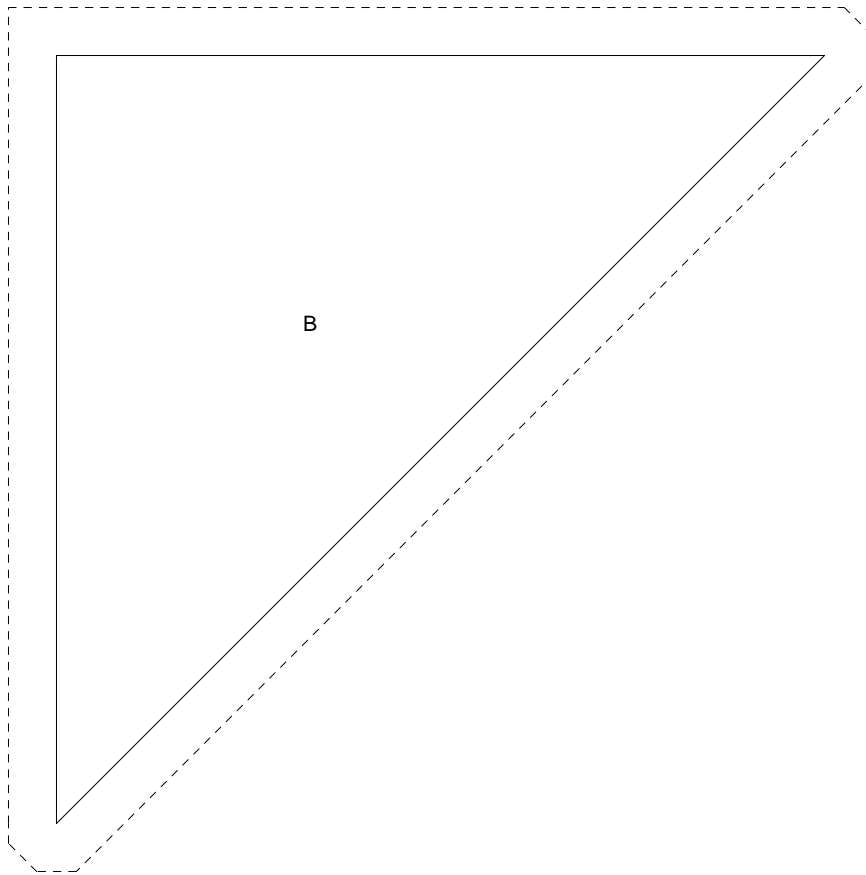
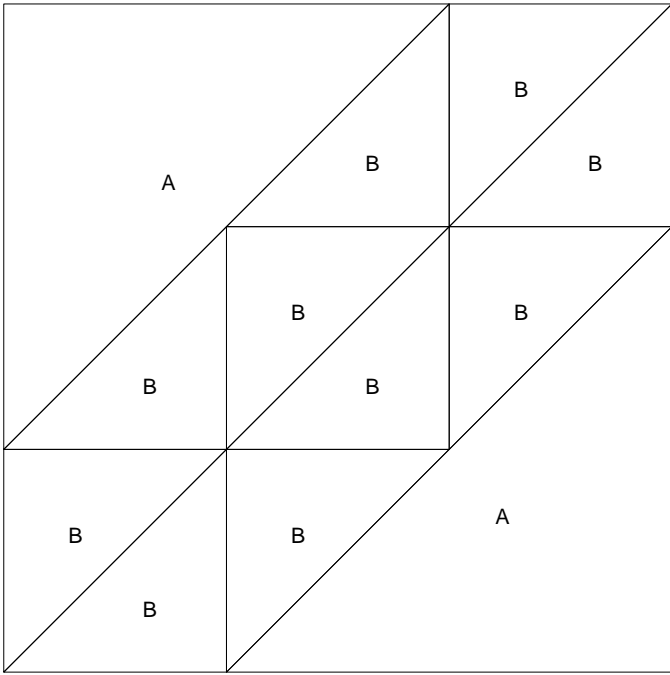

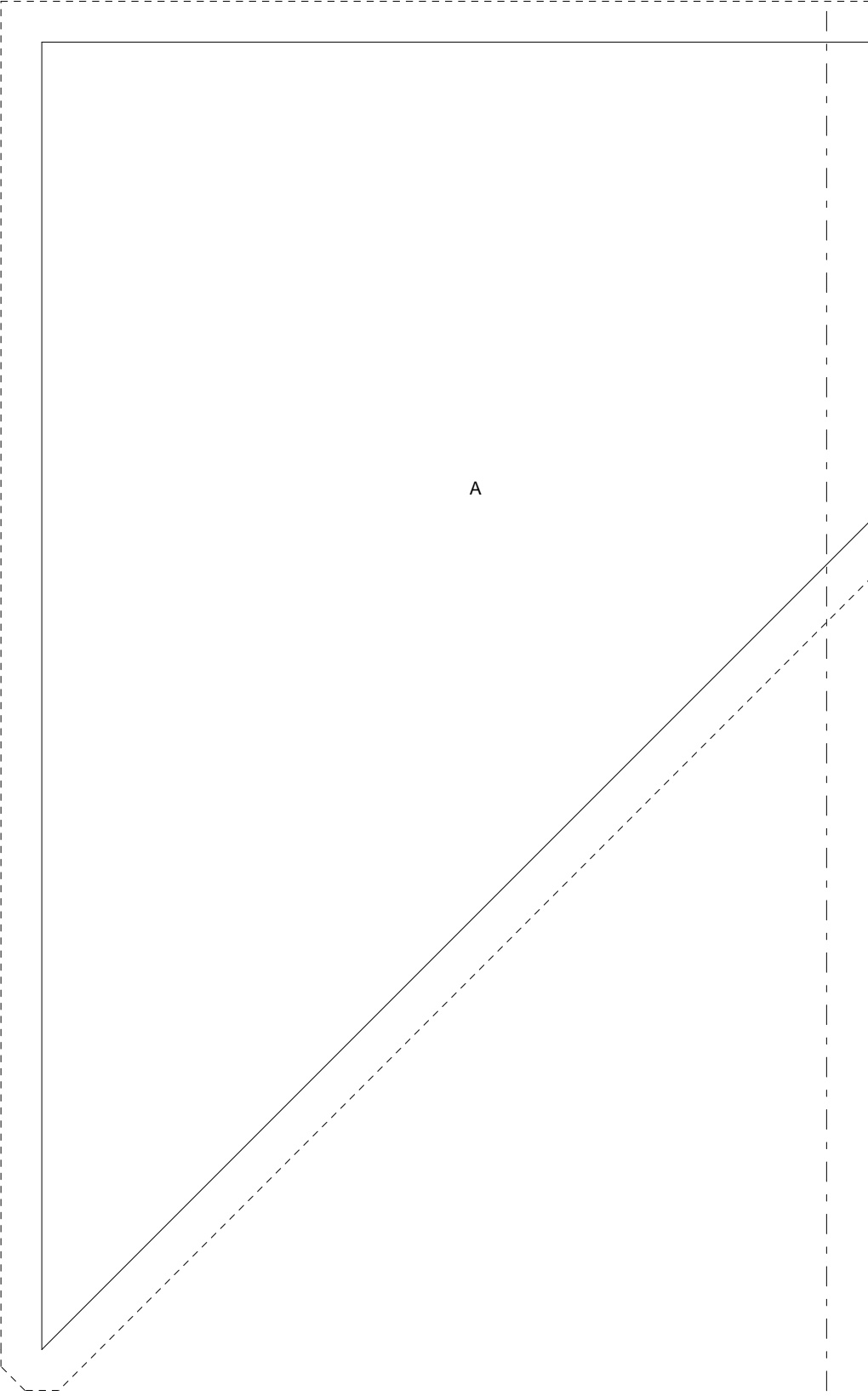

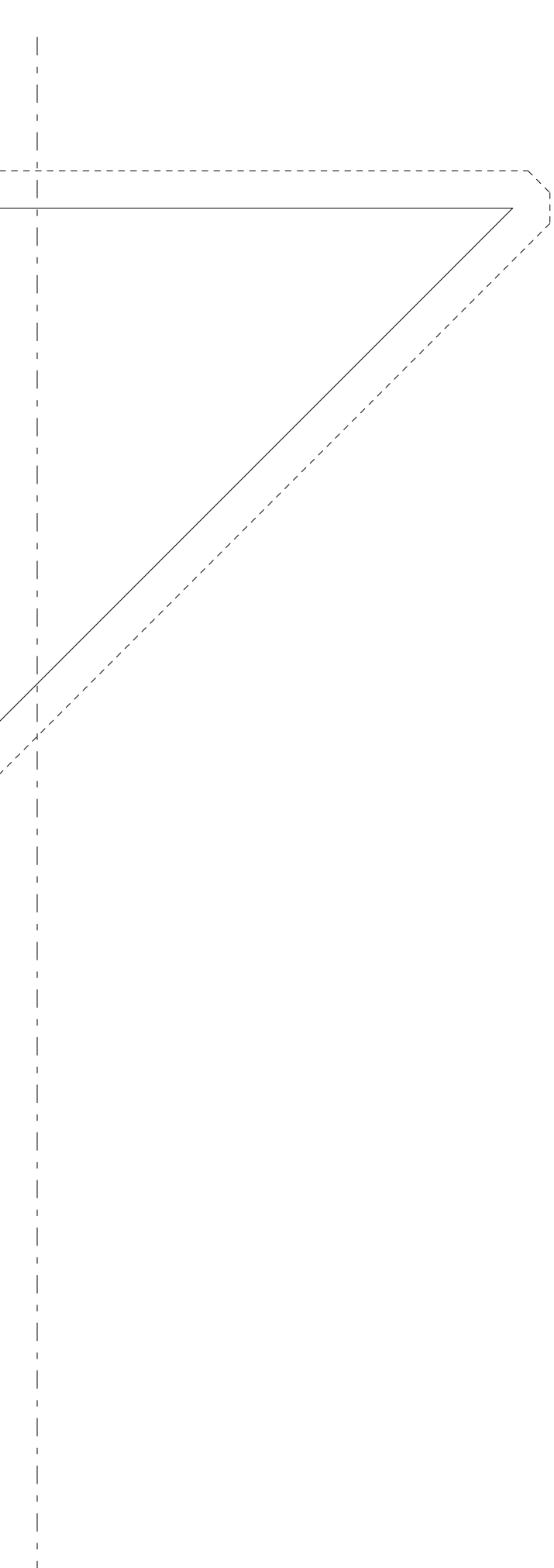

# Corn and Beans

Pattern for 12.00x12.00 block  
Key Block (1/5 actual size)

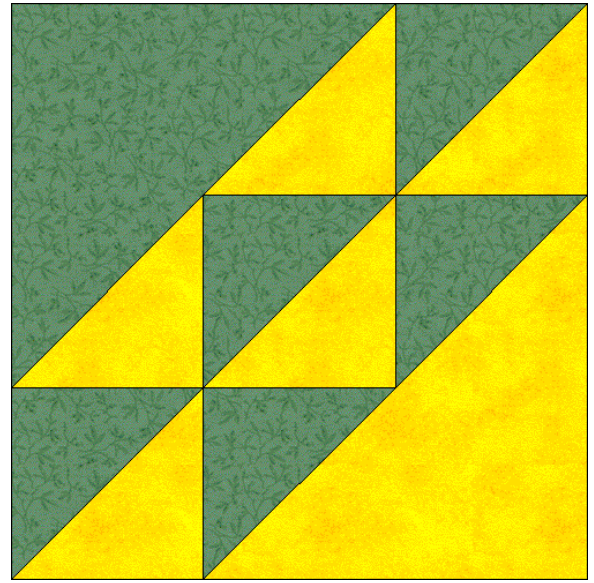
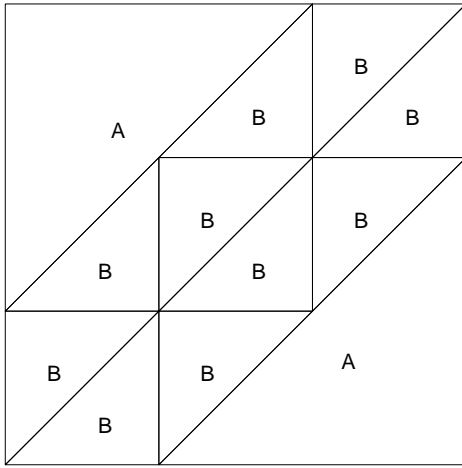

## Cutting Diagrams

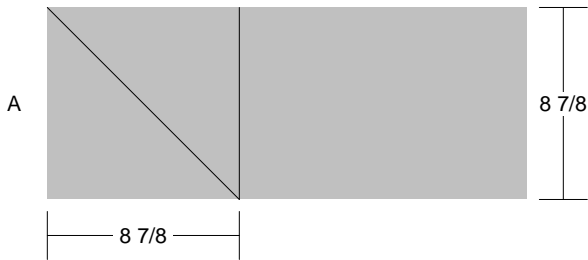

1 patch

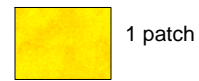

1 patch

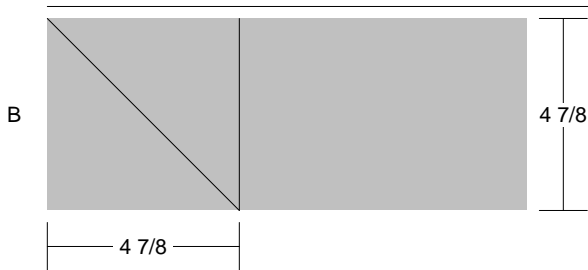

5 patches



5 patches

# Country Farm

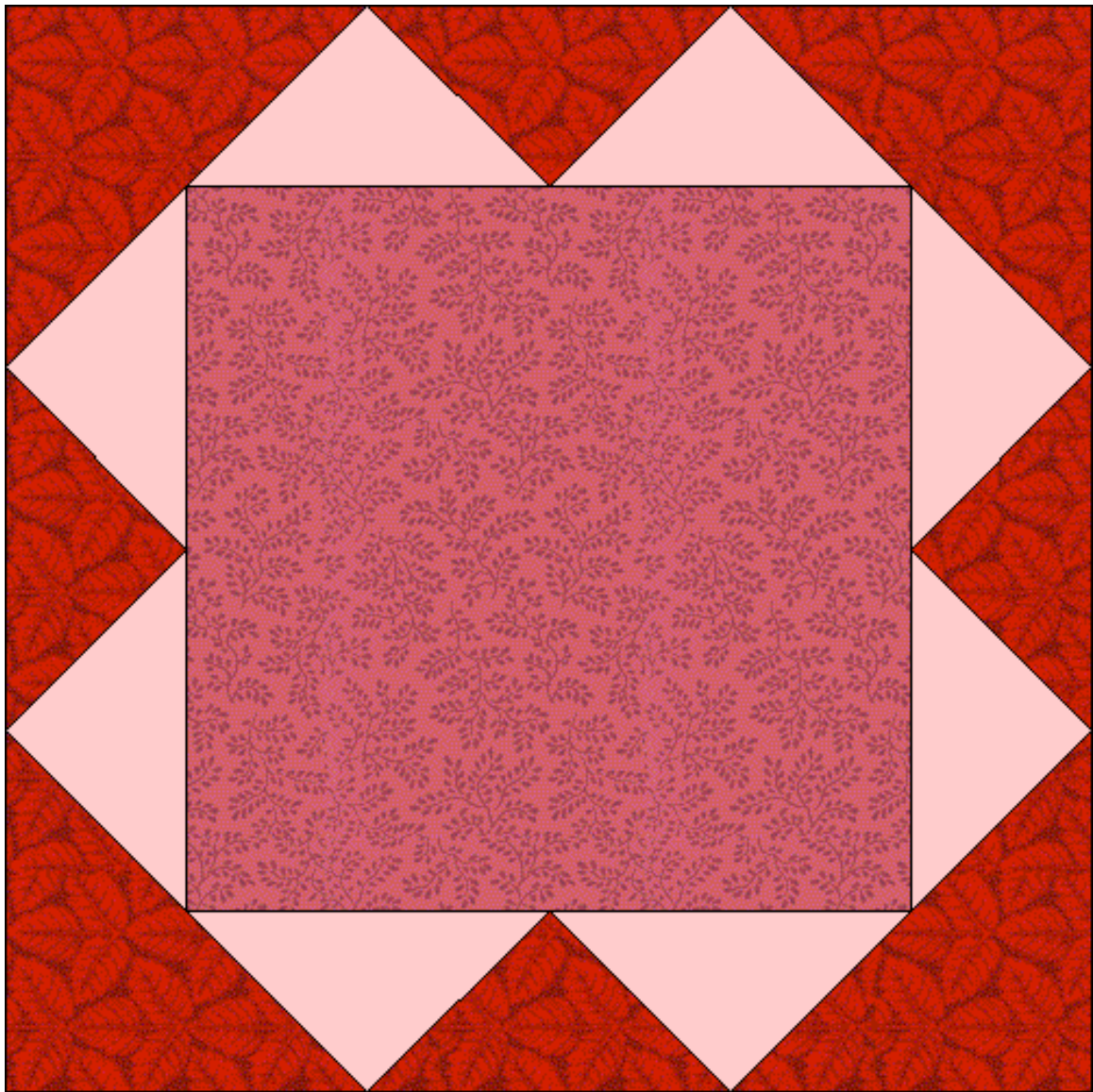

# Country Farm

Pattern for 12.00x12.00 block  
Key Block (29/100 actual size)

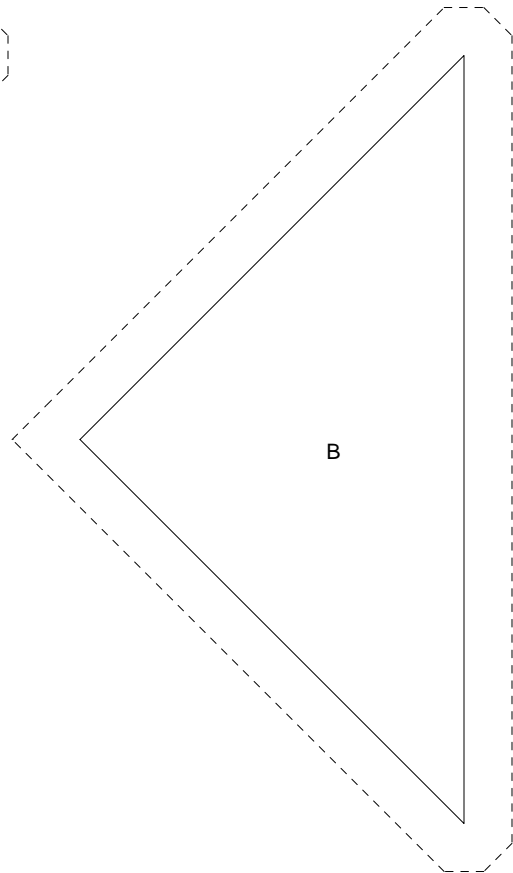
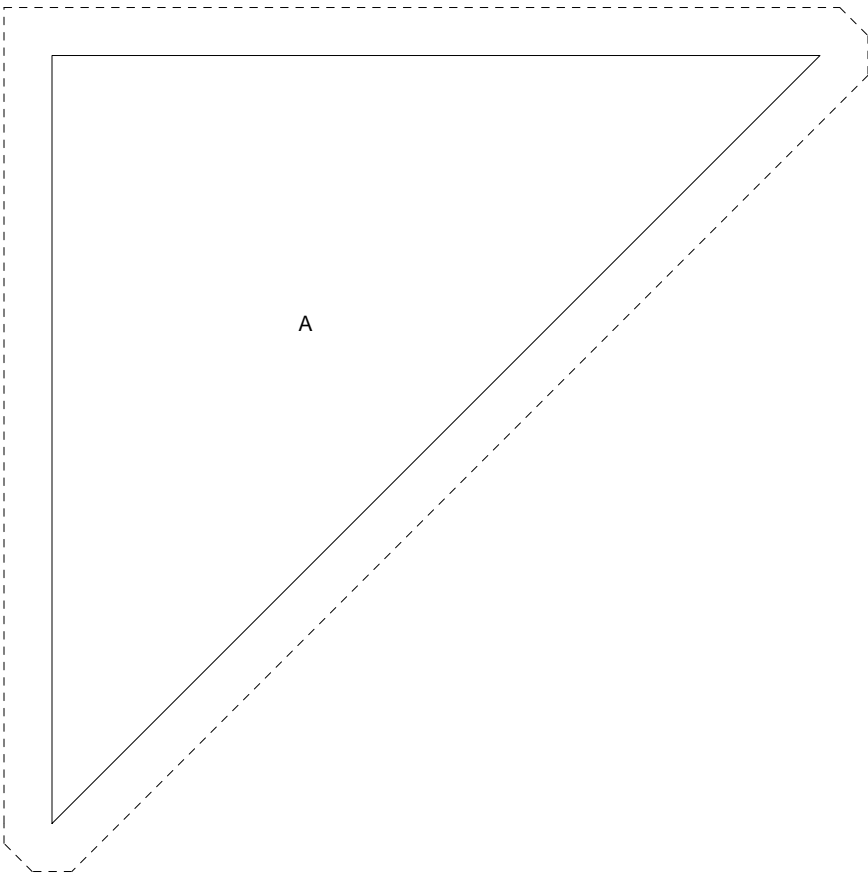
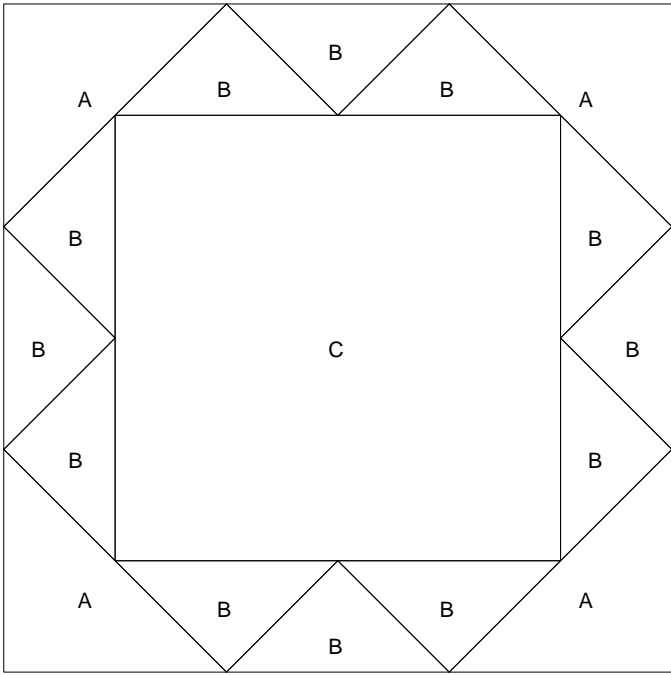

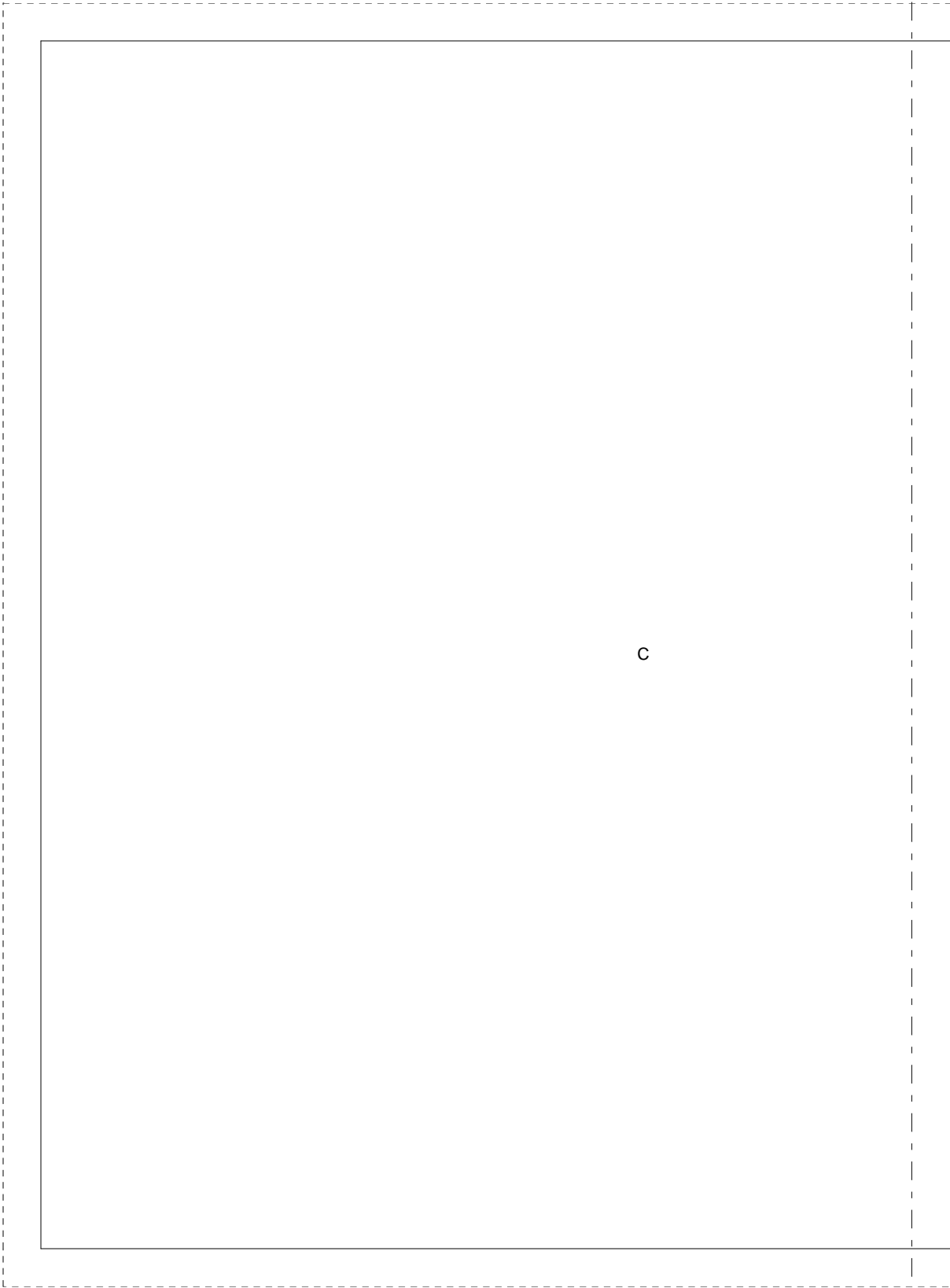

c

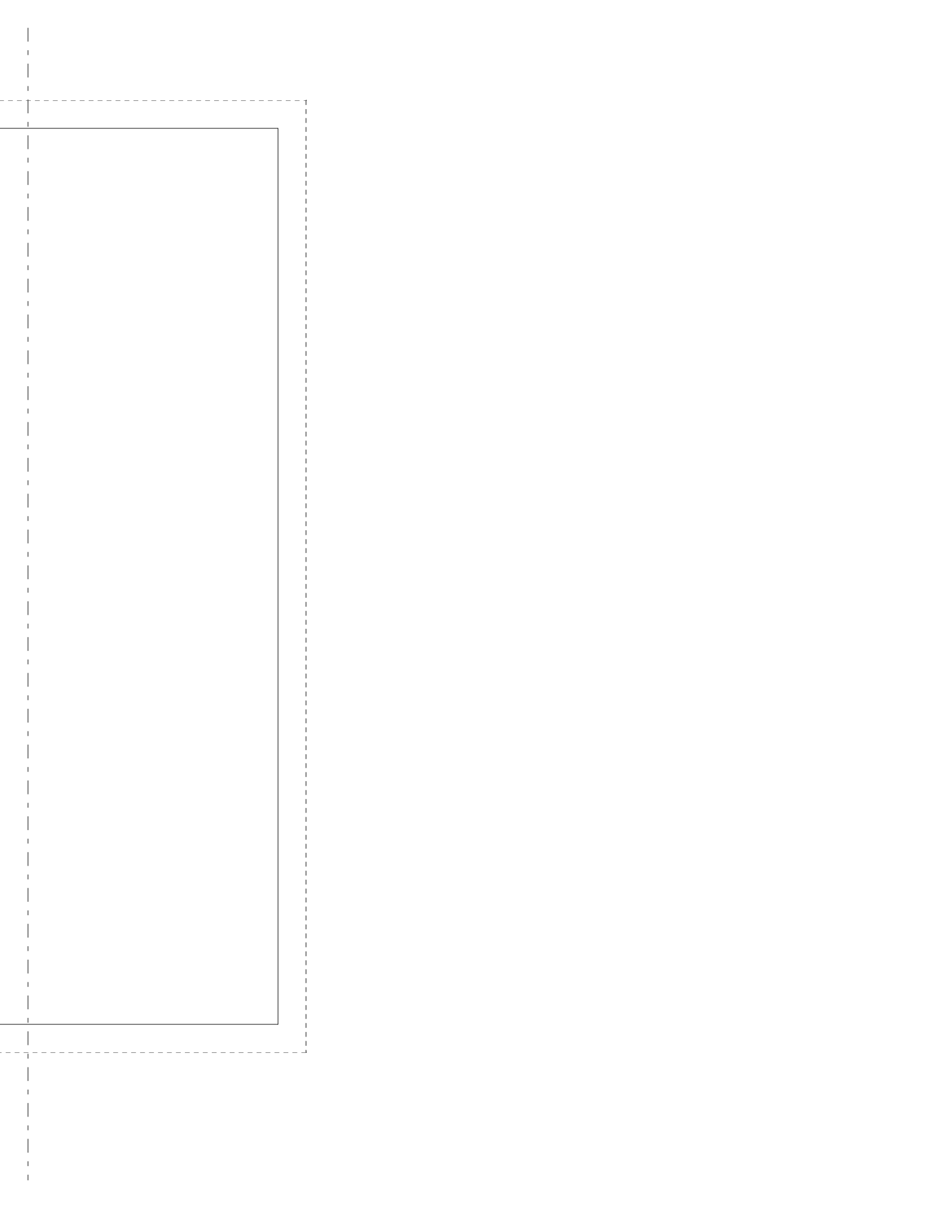

# Country Farm

Pattern for 12.00x12.00 block  
Key Block (1/5 actual size)

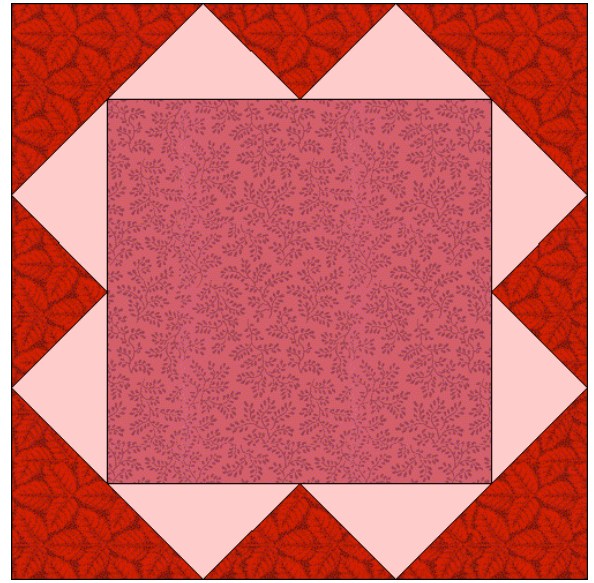
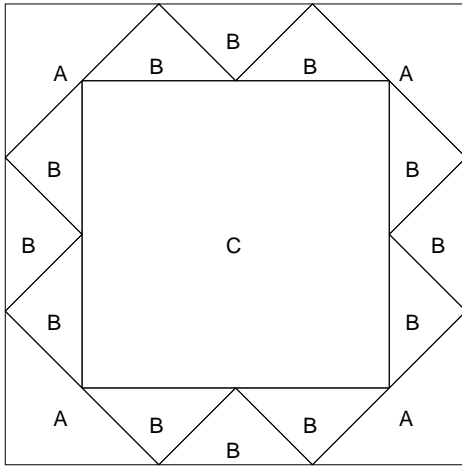

## Cutting Diagrams

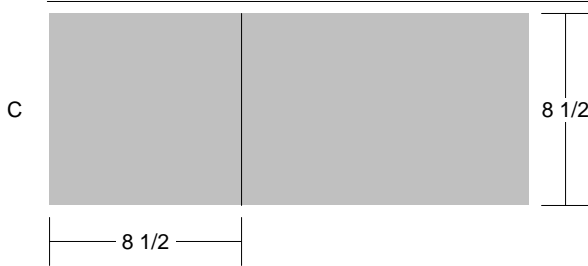
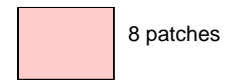
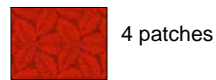
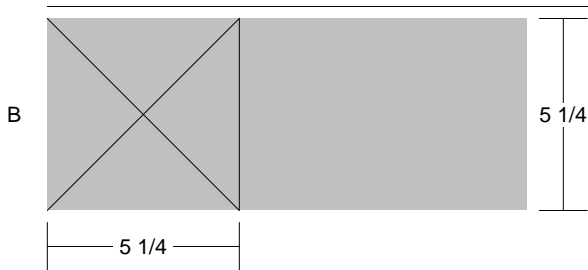
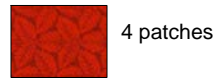
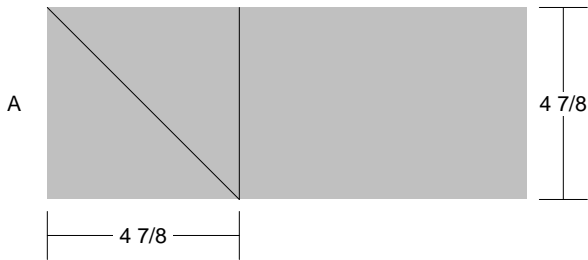

## Patch Count

# Hens and Chickens

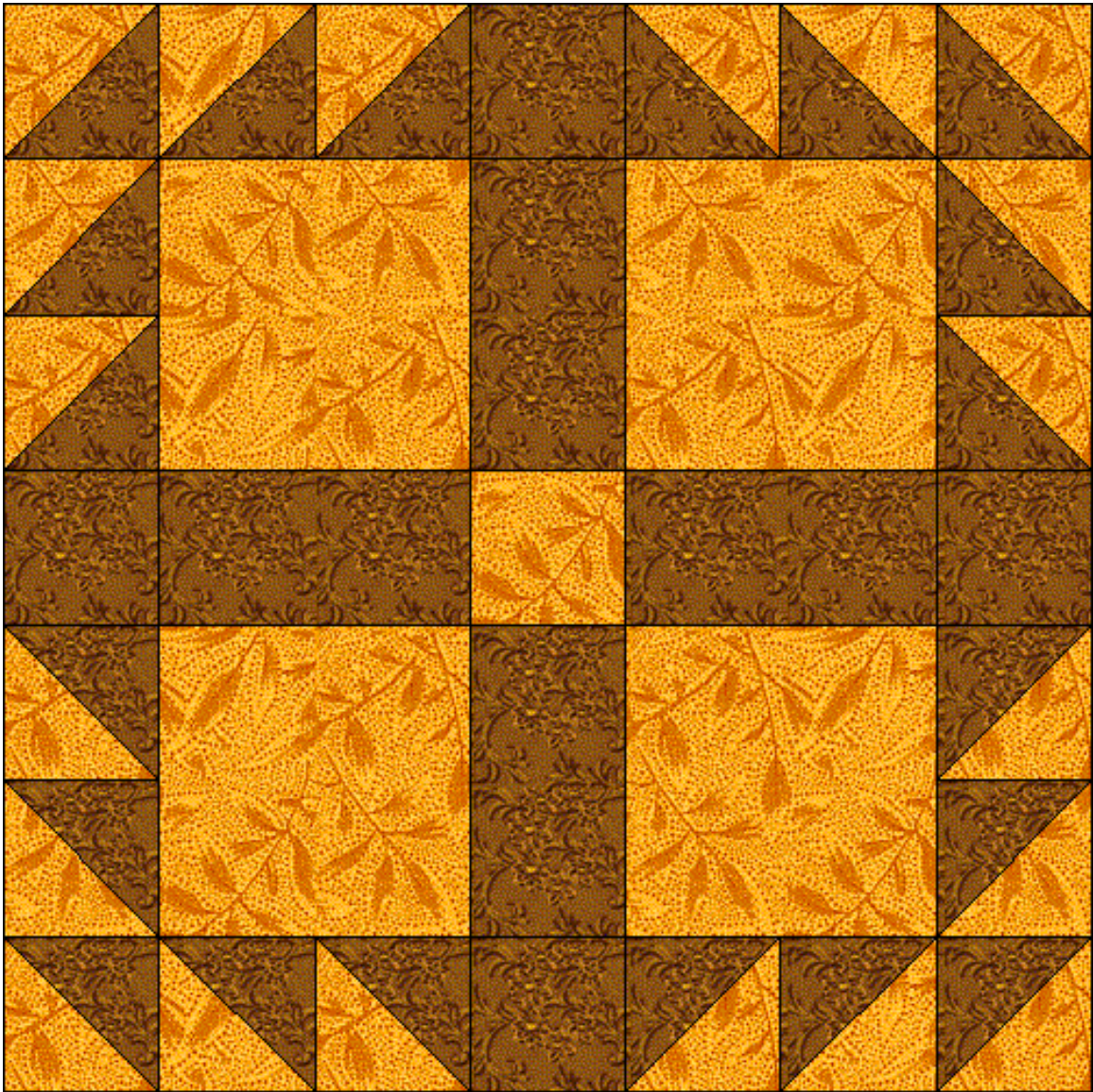

# Hens and Chickens

Pattern for 14.00x14.00 block  
Key Block (12/50 actual size)

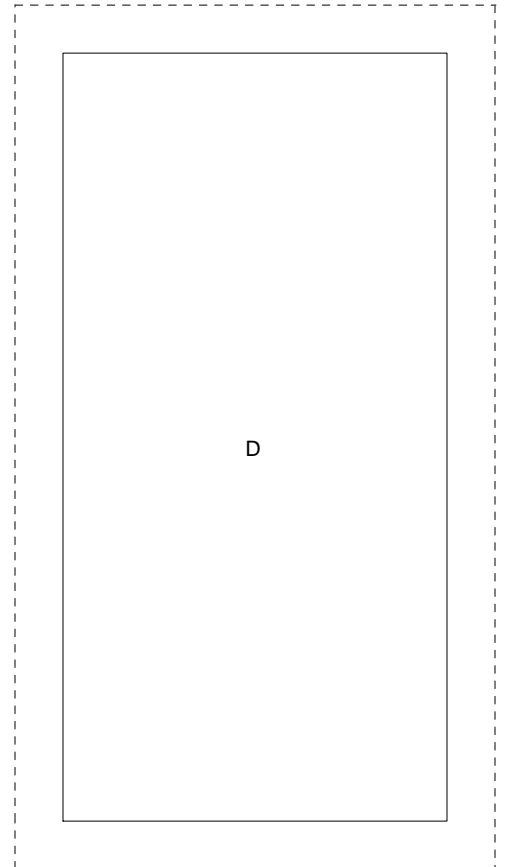
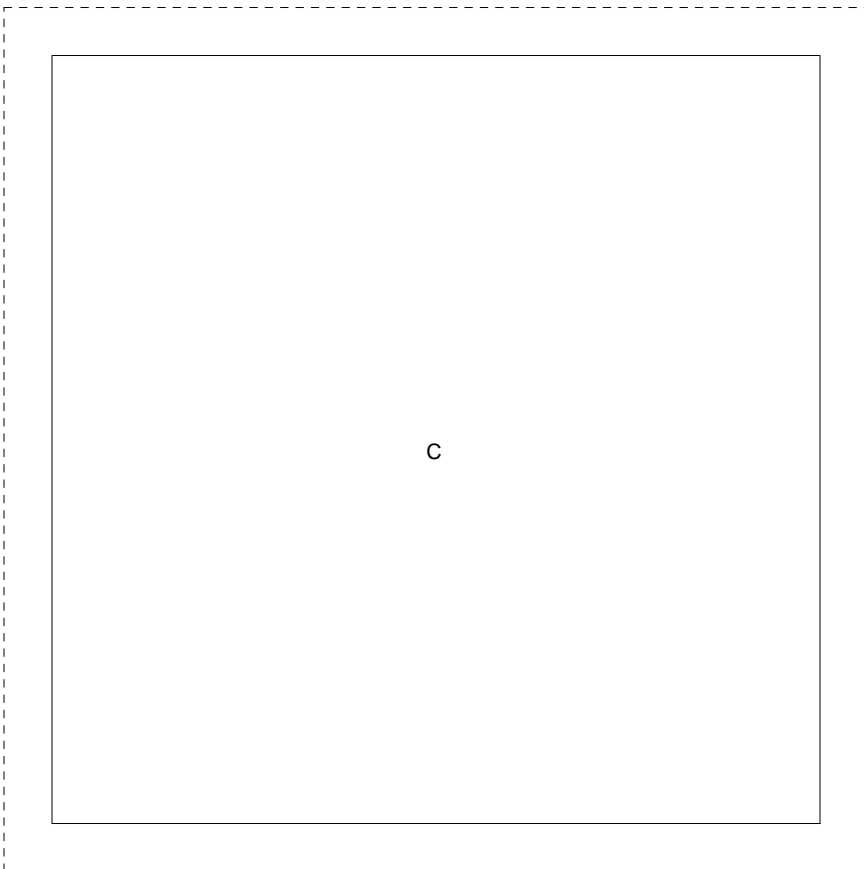
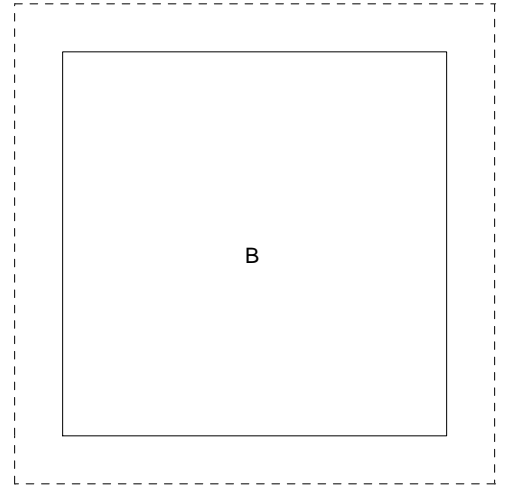
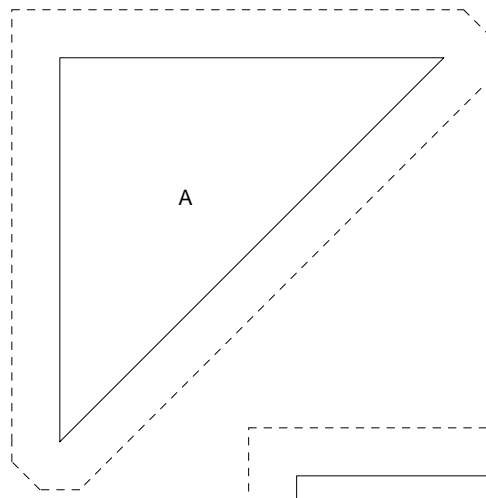
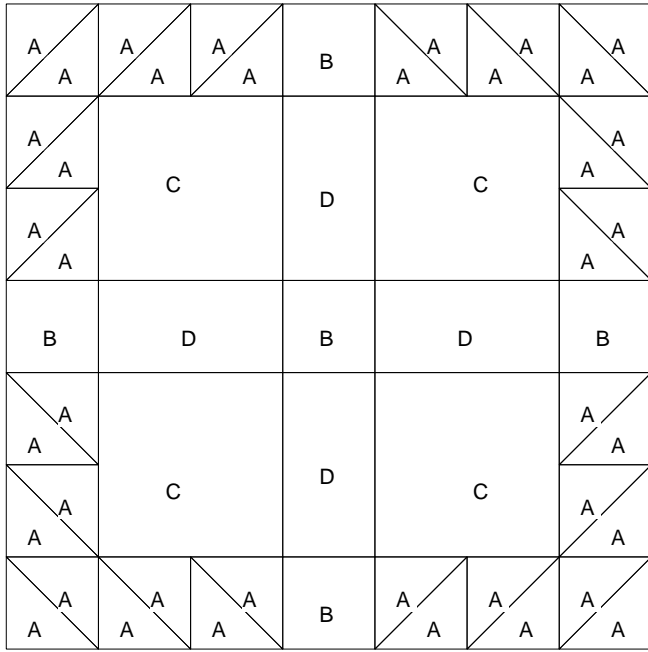

# Hens and Chickens

Pattern for 14.00x14.00 block  
Key Block (17/100 actual size)

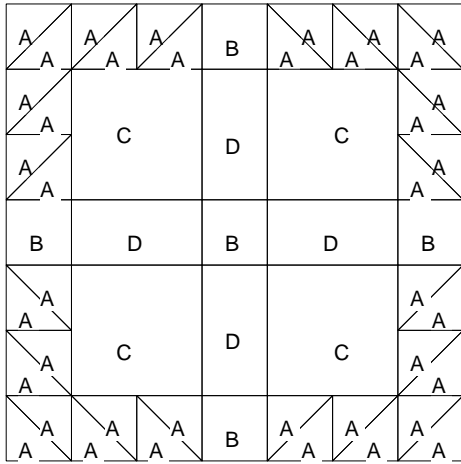

## Cutting Diagrams

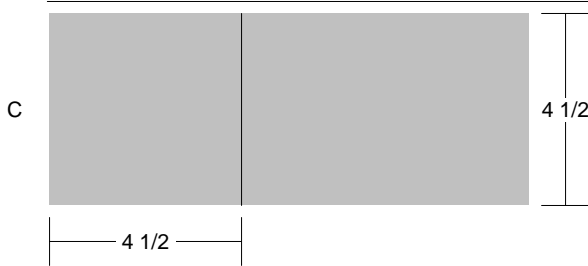
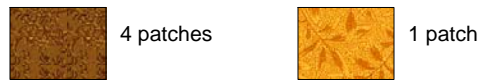
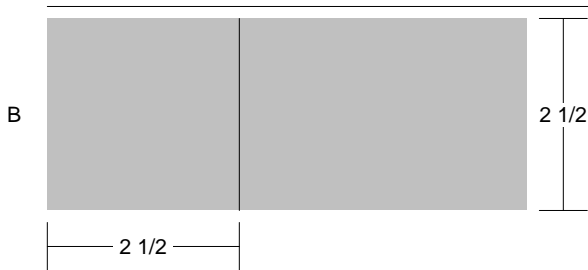
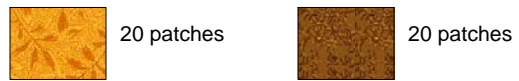
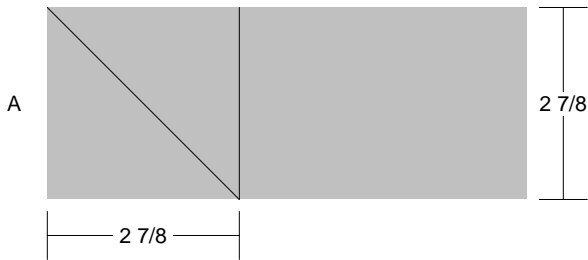

D

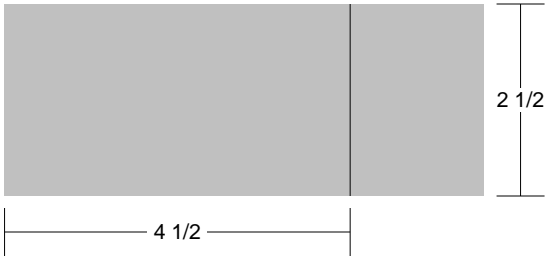

4 patches



# Missouri Corn Field

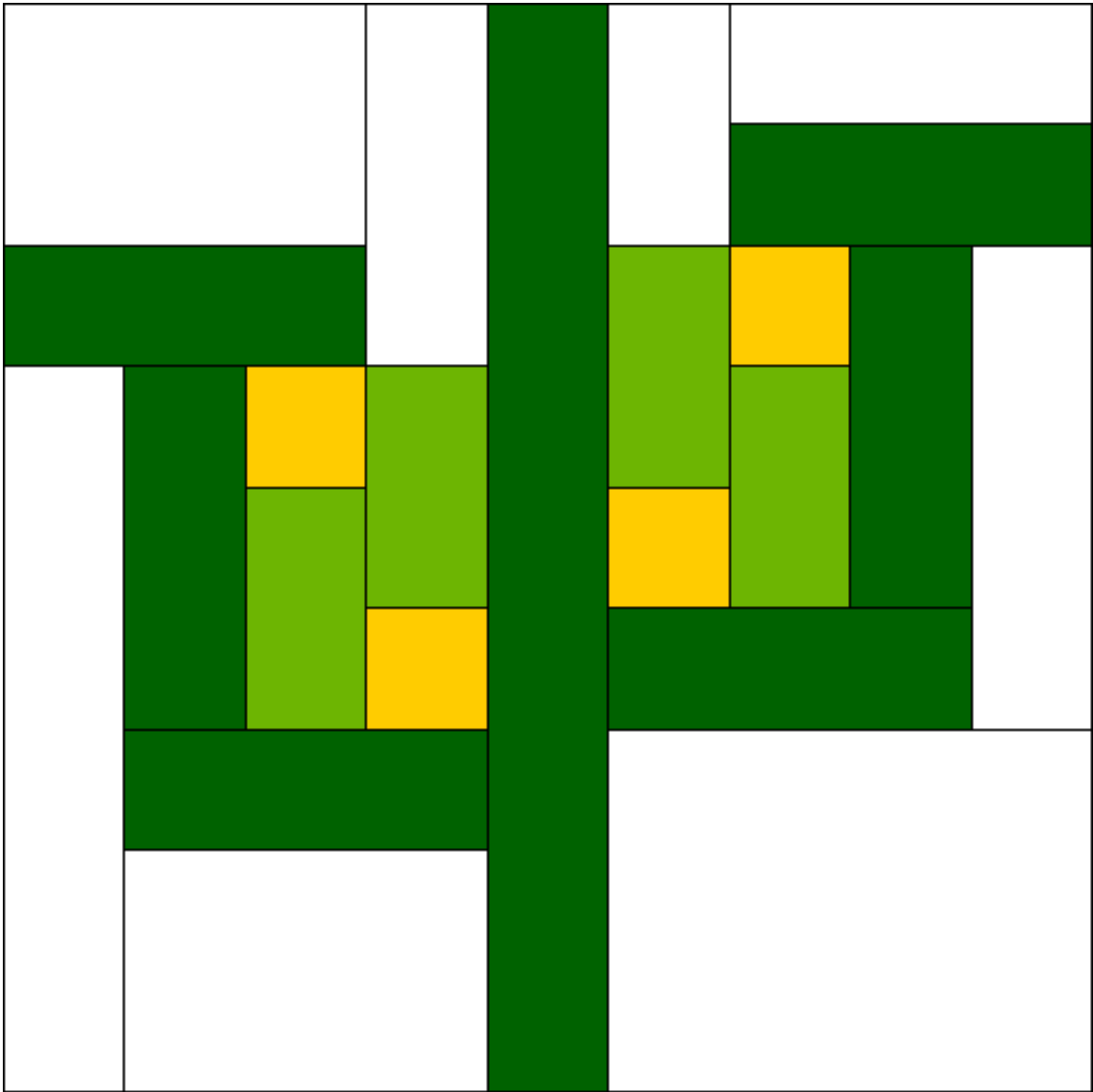

# Missouri Corn Field

Pattern for 9.00x9.00 block  
Key Block (27/100 actual size)

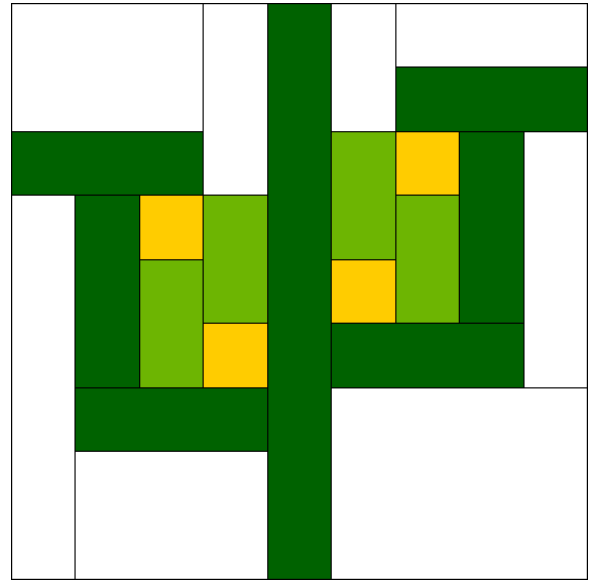
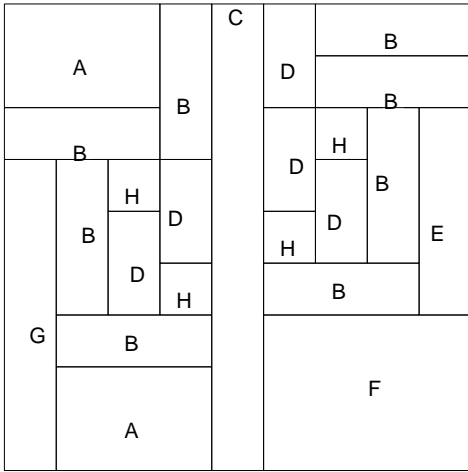

## Cutting Diagrams

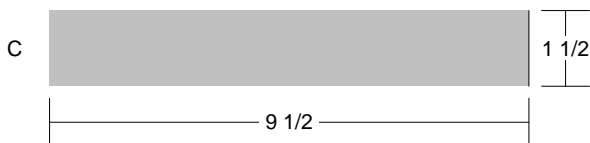
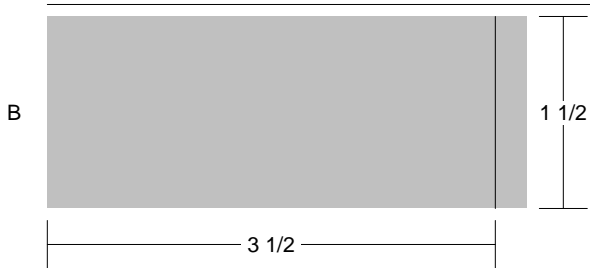
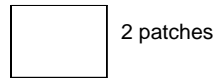
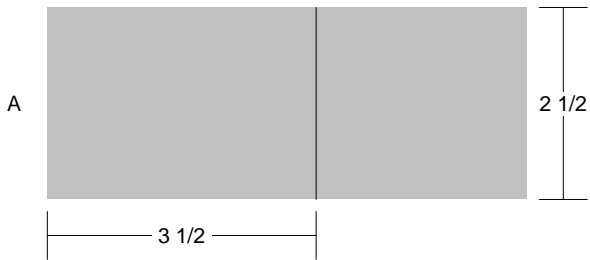

## Patch Count

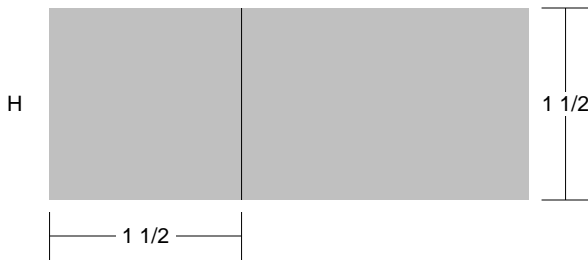
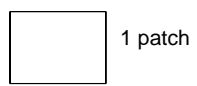
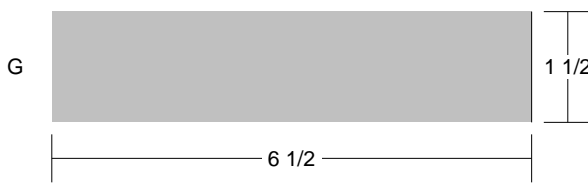
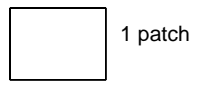
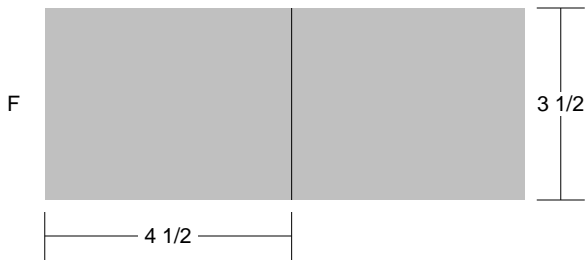
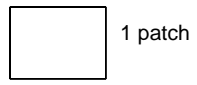
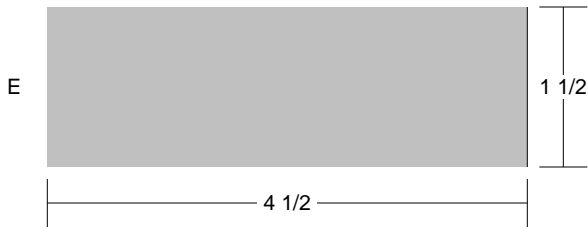
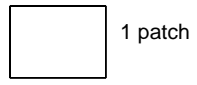
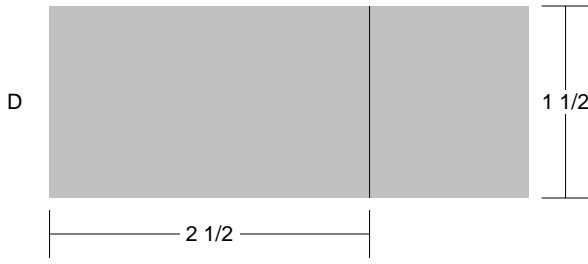

# Missouri Corn Field

Pattern for 9.00x9.00 block  
Key Block (19/50 actual size)

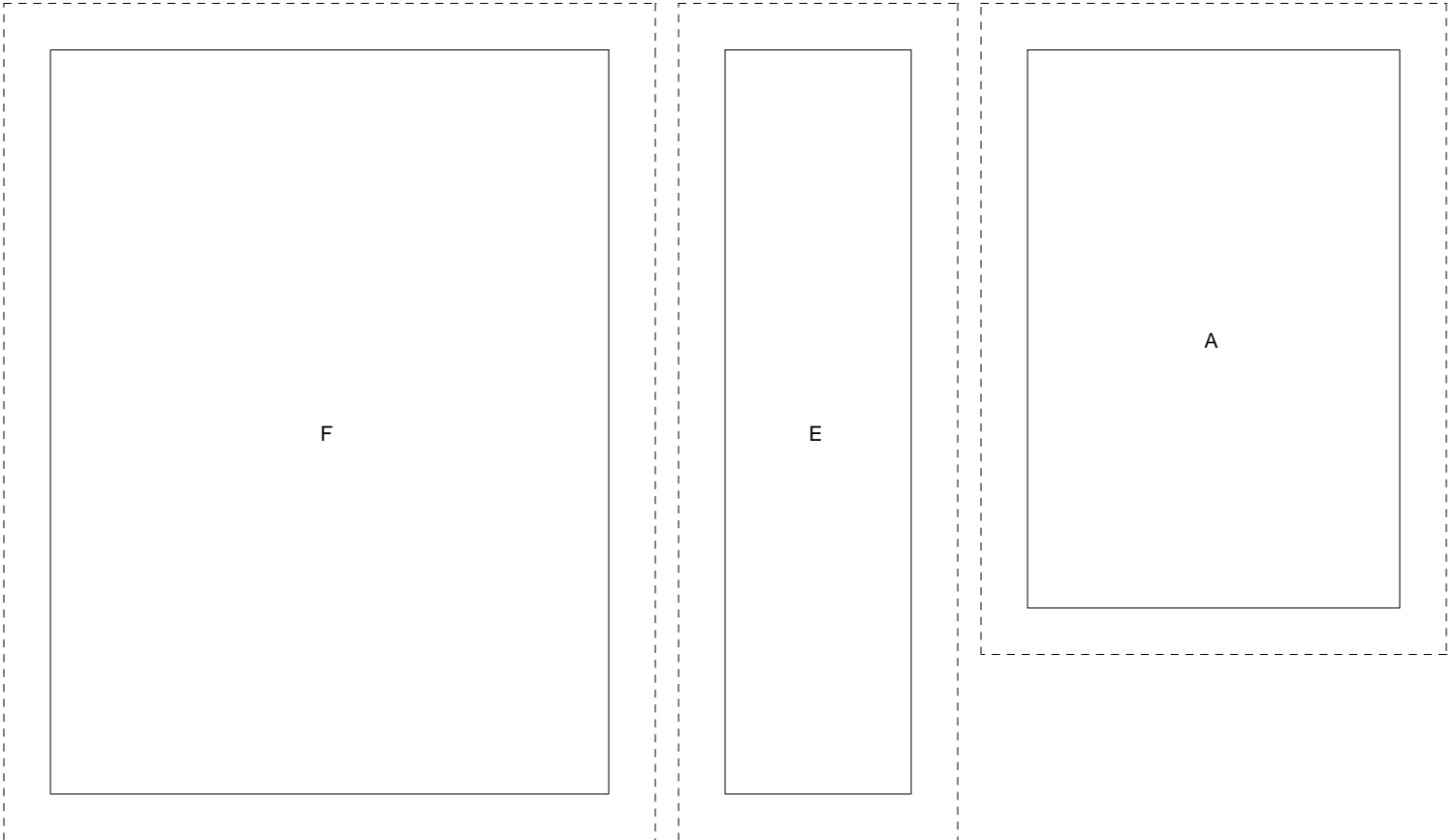
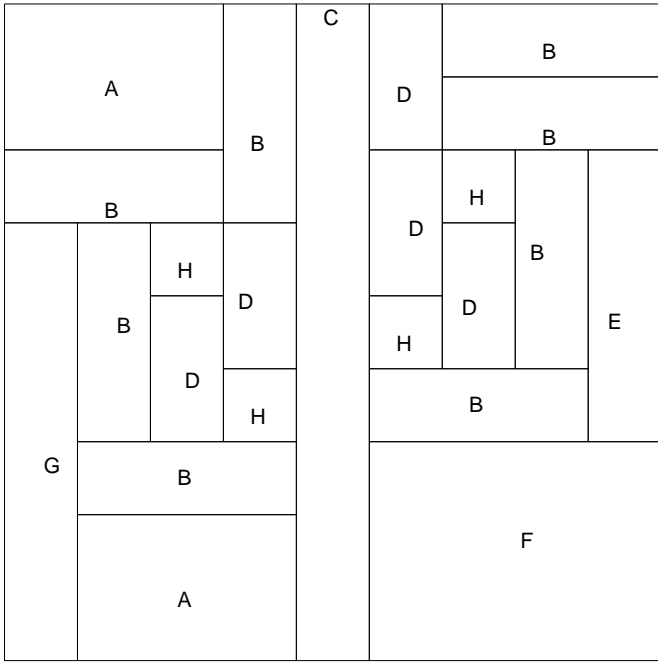

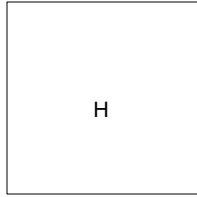
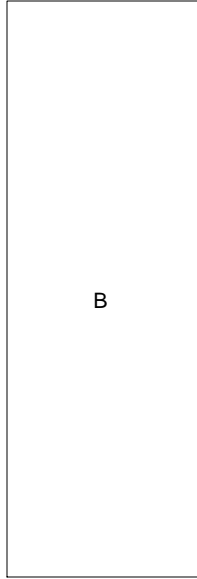
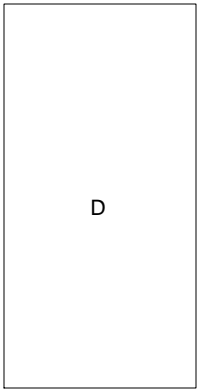
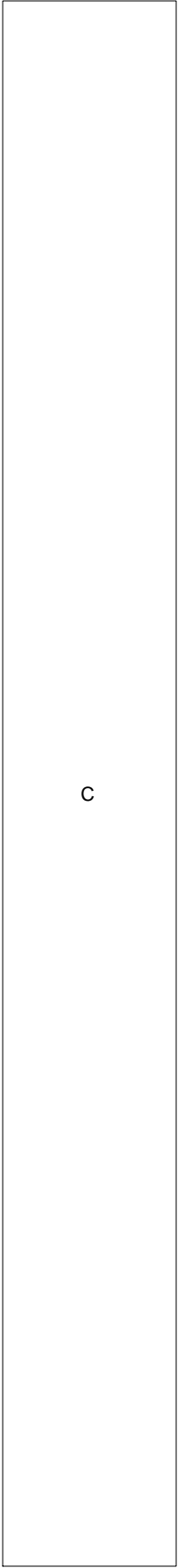

# Practical Orchard

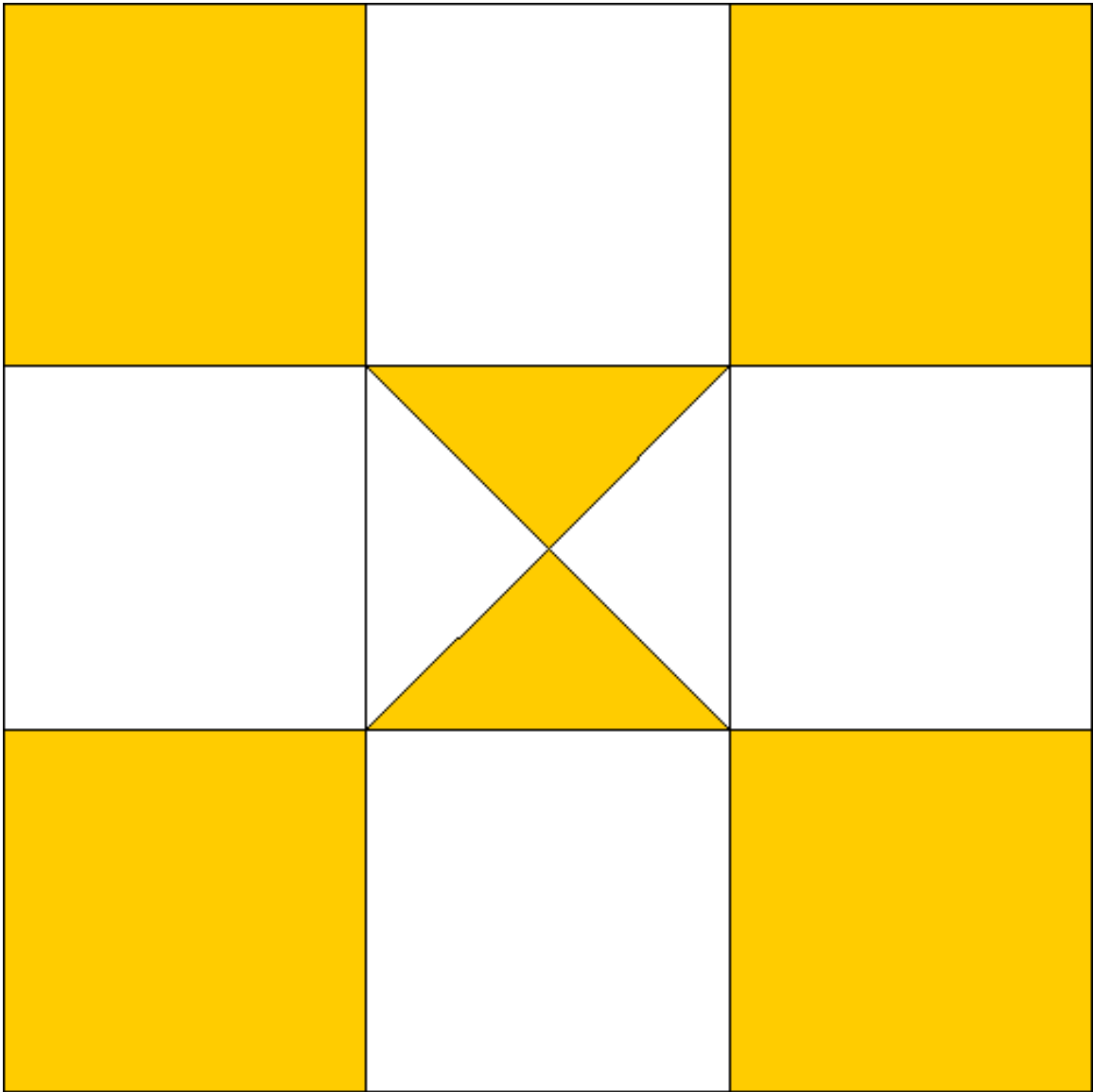

# Practical Orchard

Pattern for 12.00x12.00 block  
Key Block (29/100 actual size)

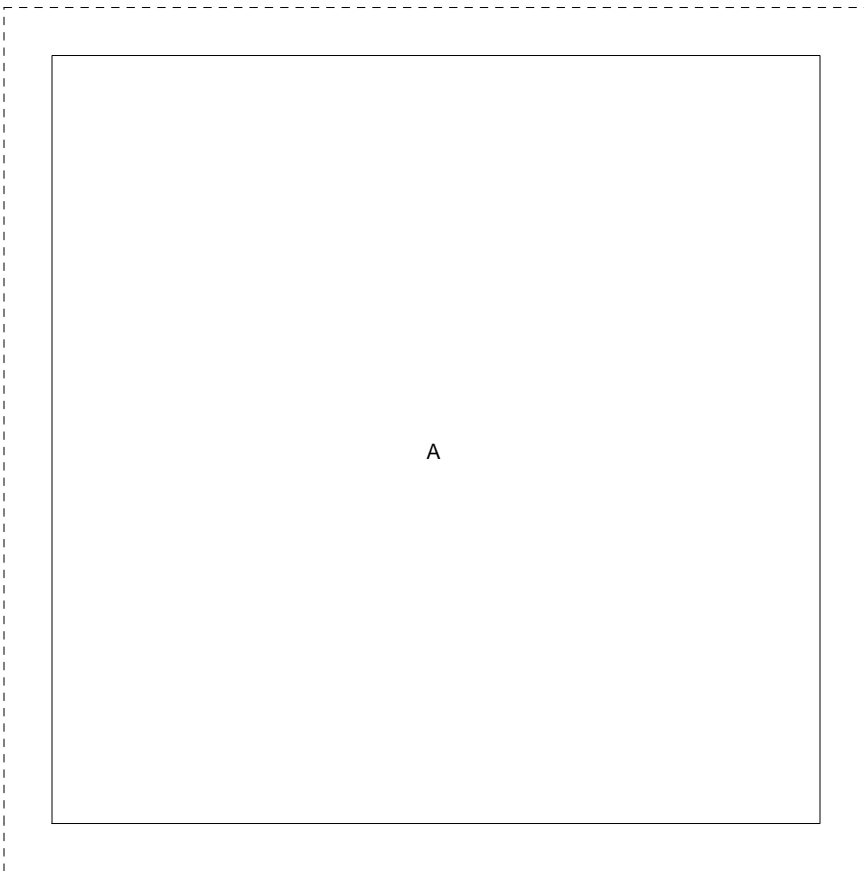
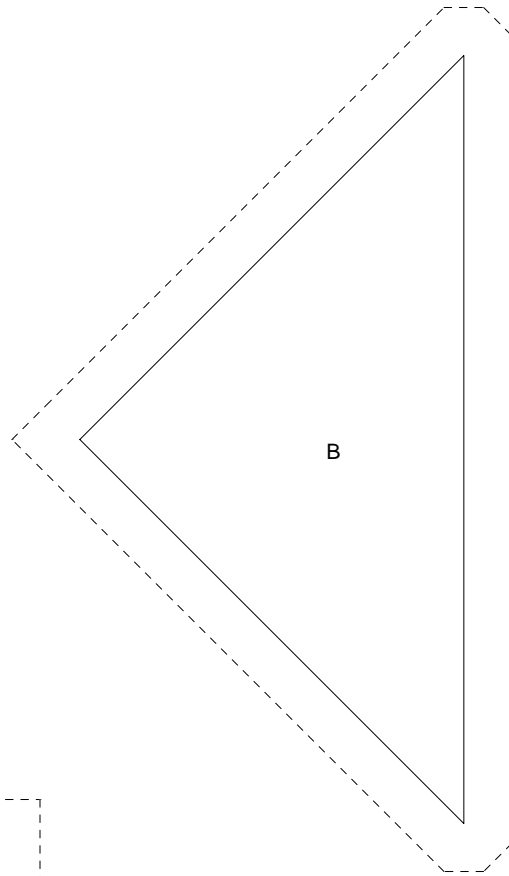
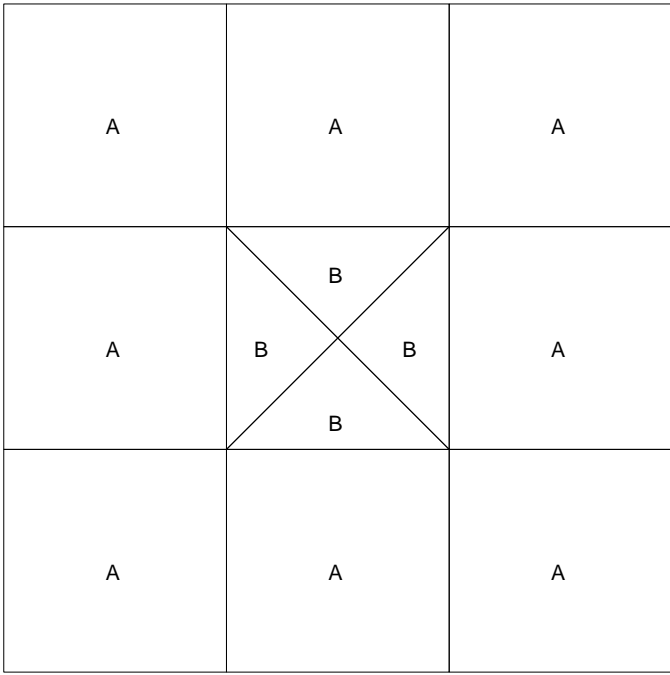

# Practical Orchard

Pattern for 12.00x12.00 block  
Key Block (1/5 actual size)

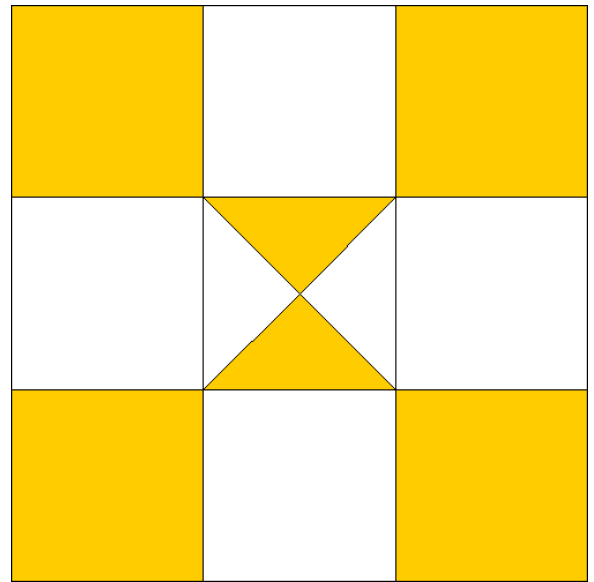
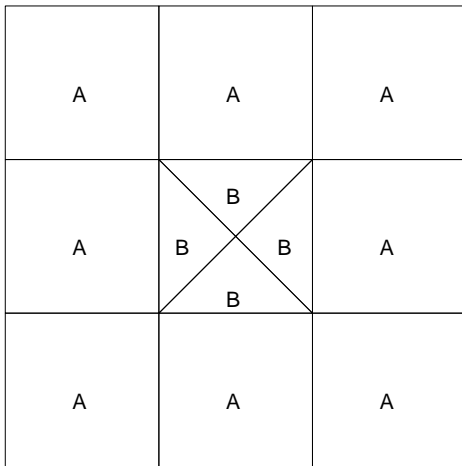

## Cutting Diagrams

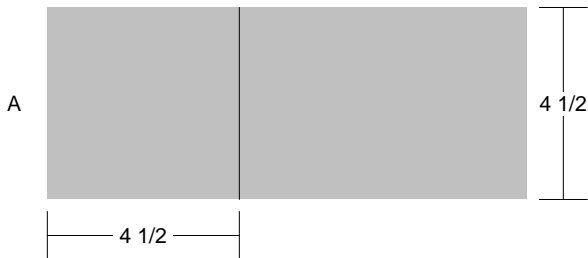

## Patch Count

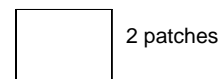
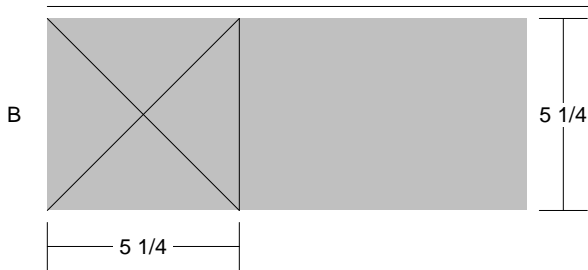
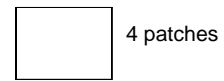

# Prairie Home

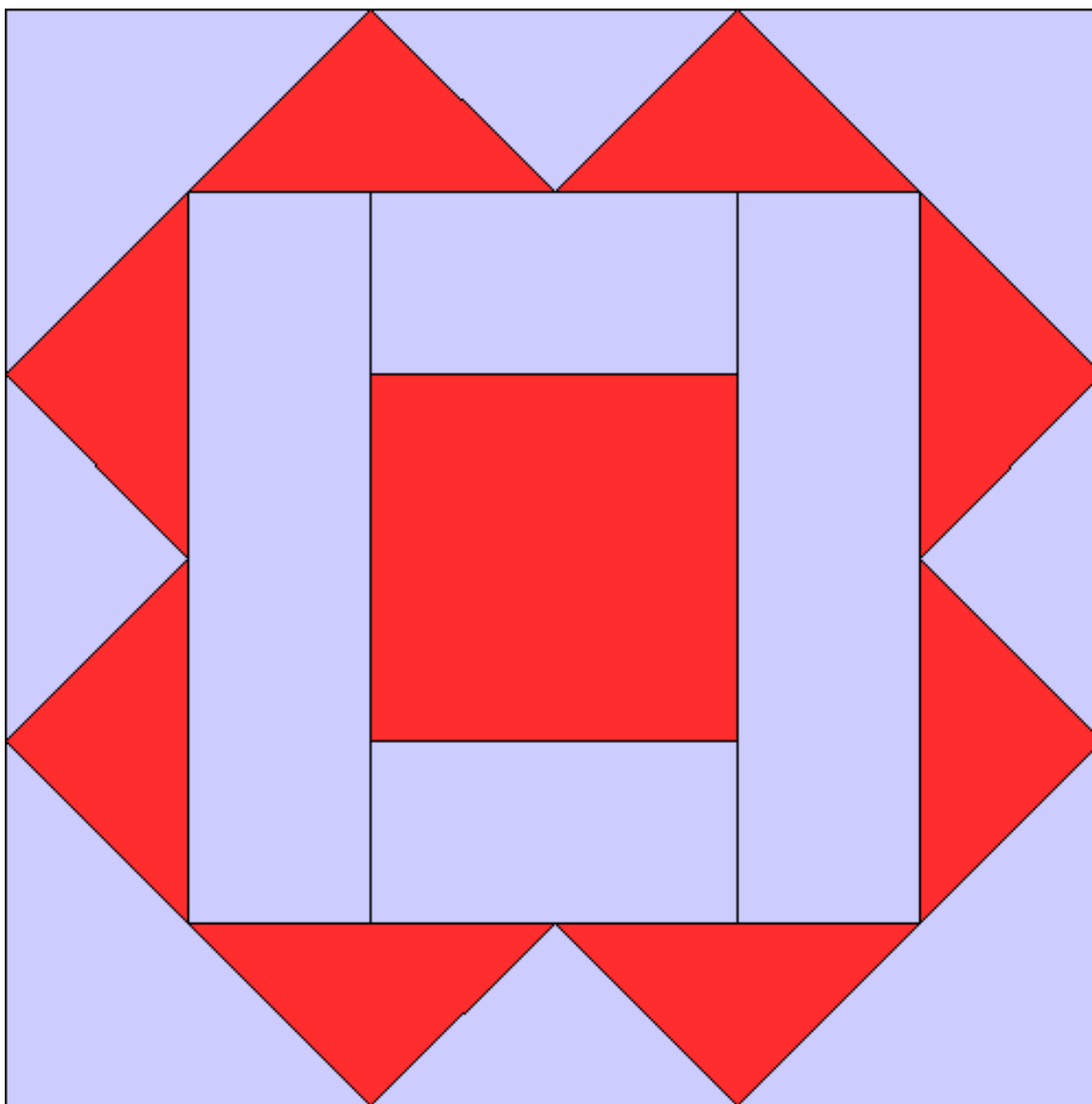

**Prairie Home**  
Pattern for 12.00x12.00 block  
Key Block (29/100 actual size)

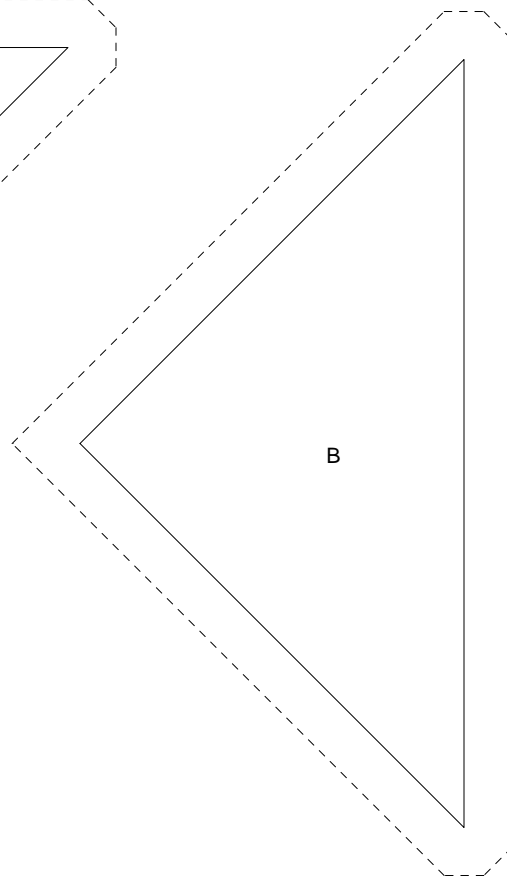
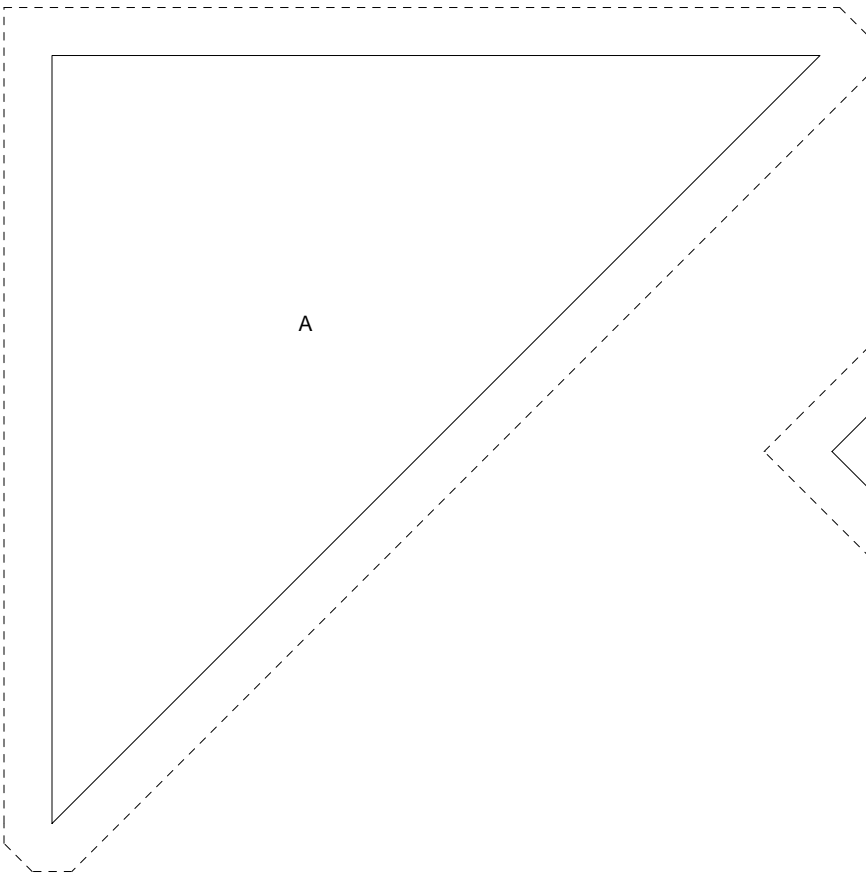
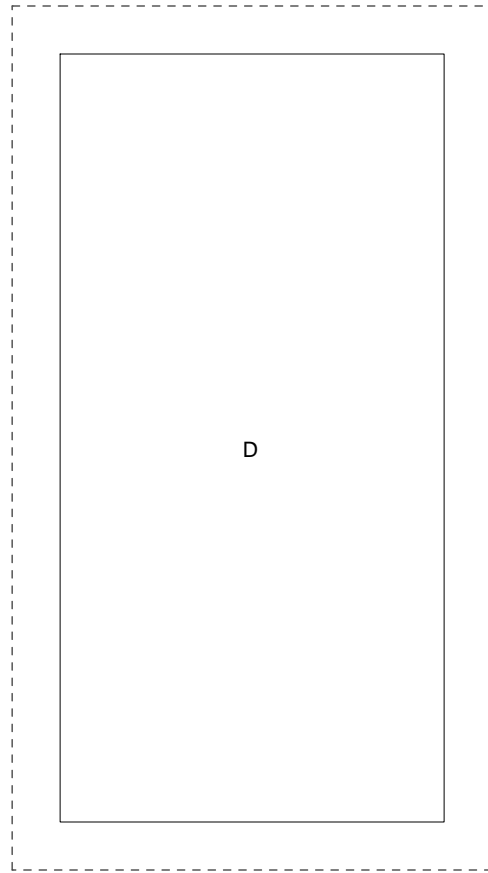
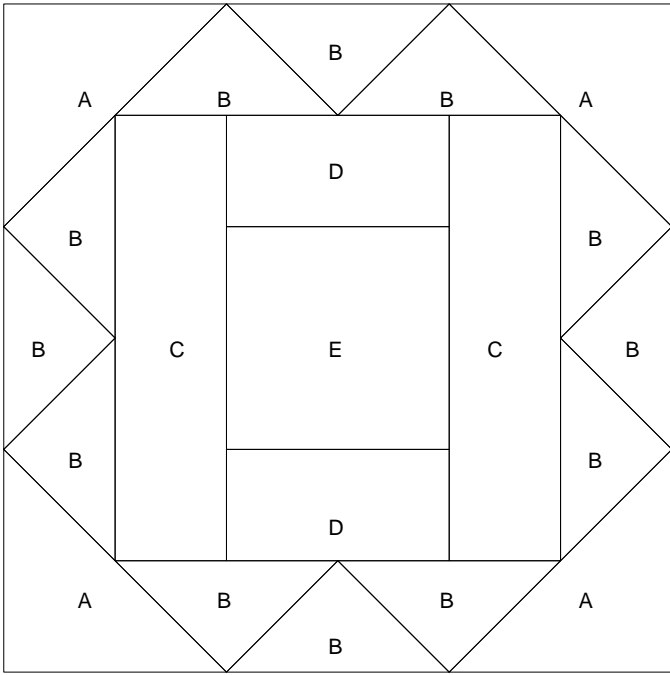

The diagram consists of a large dashed rectangular boundary. Inside this boundary, there are two smaller rectangular regions. Region C is a vertical rectangle on the left side. Region E is a horizontal rectangle on the right side. Both regions are defined by solid lines, while the outer boundary and the space between the two regions are defined by dashed lines.

C

E

# Prairie Home

Pattern for 12.00x12.00 block  
Key Block (1/5 actual size)

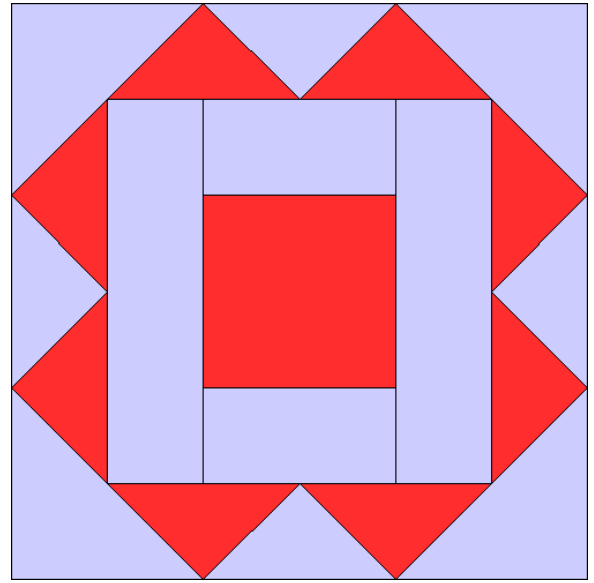
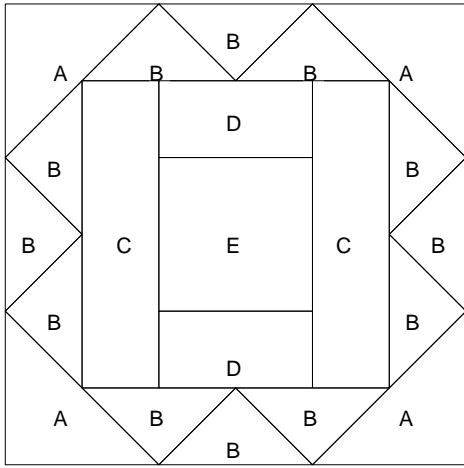

## Cutting Diagrams

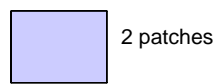
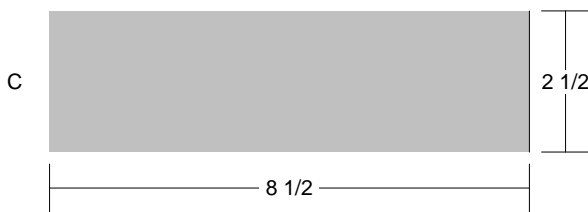
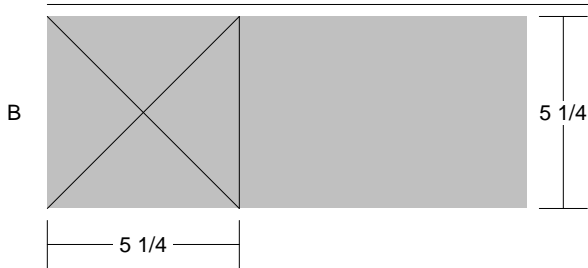
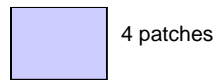
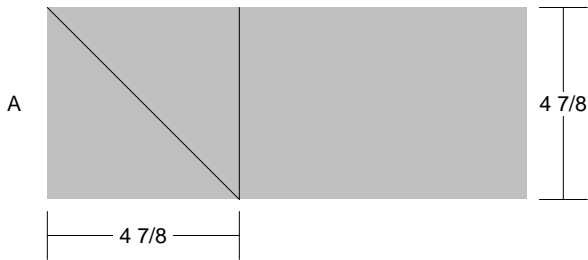

## Patch Count

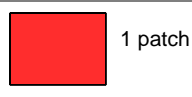
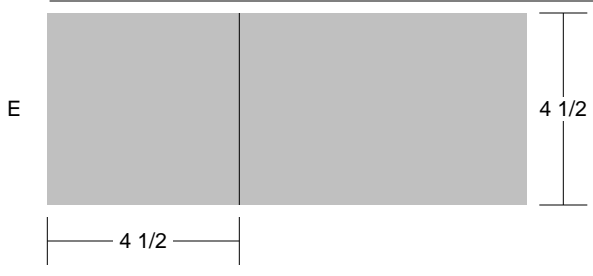
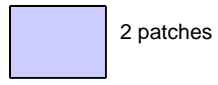
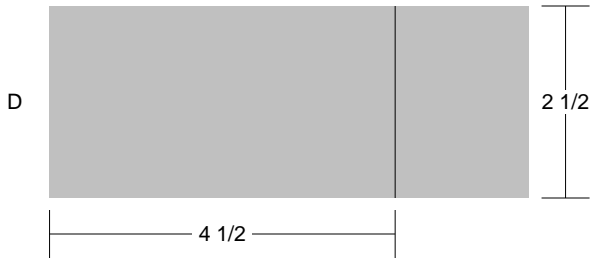

# Sunflower

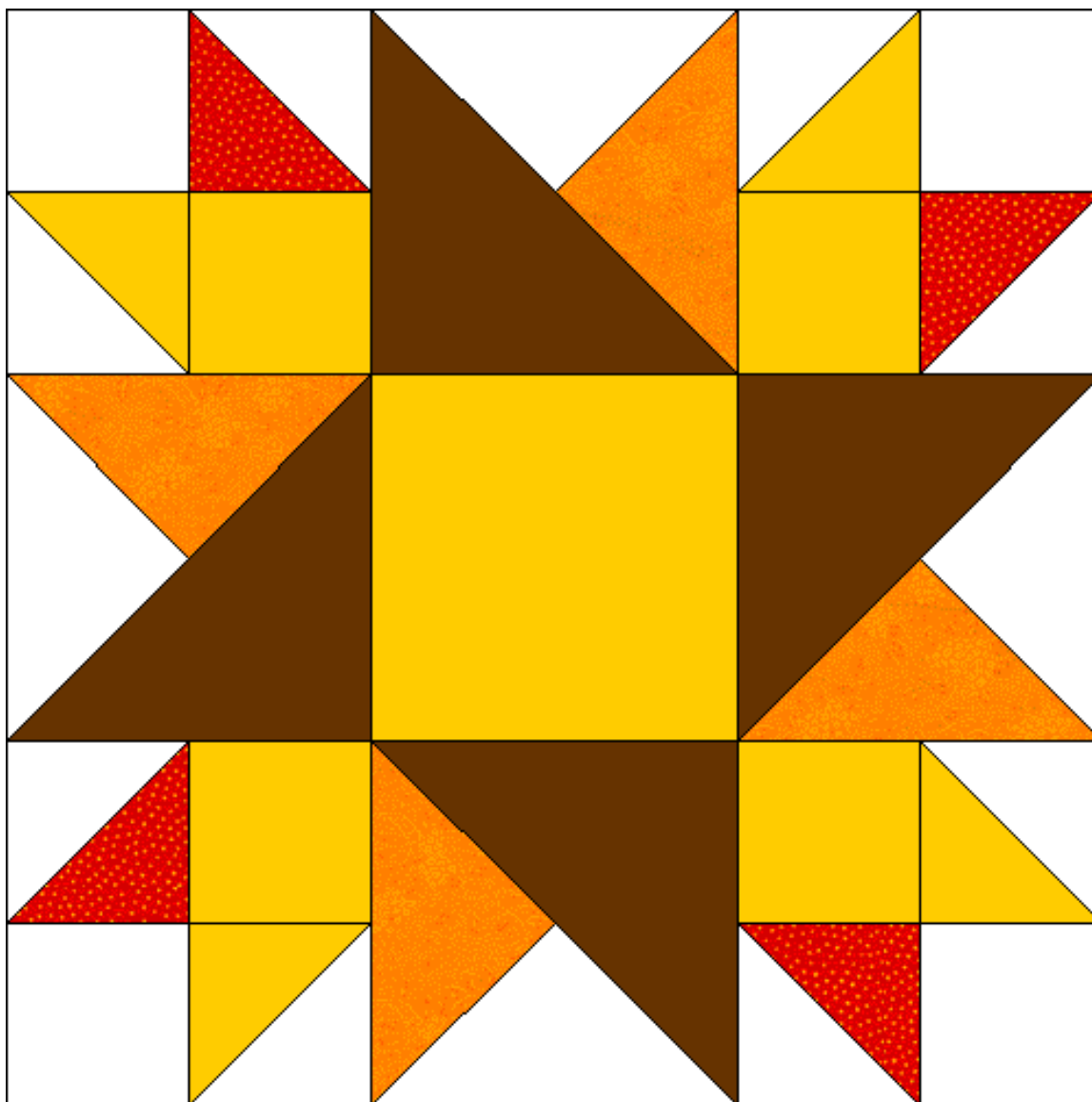

# Sunflower

Pattern for 12.00x12.00 block  
Key Block (29/100 actual size)

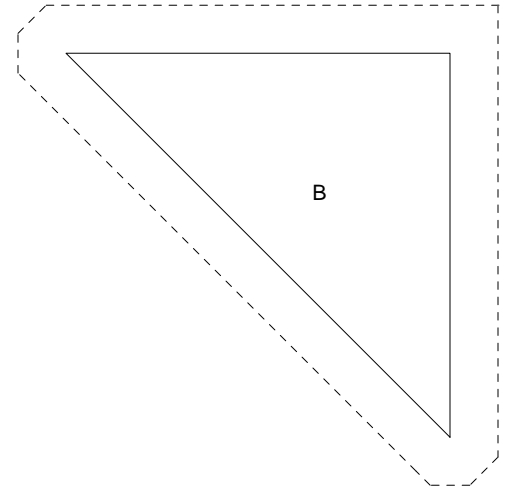
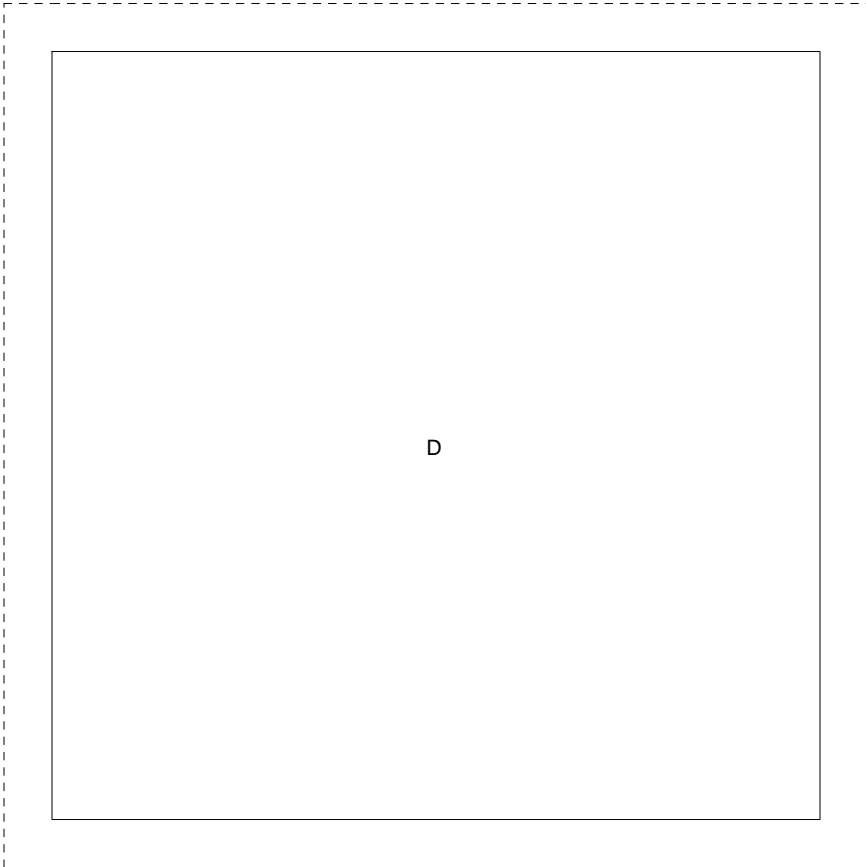
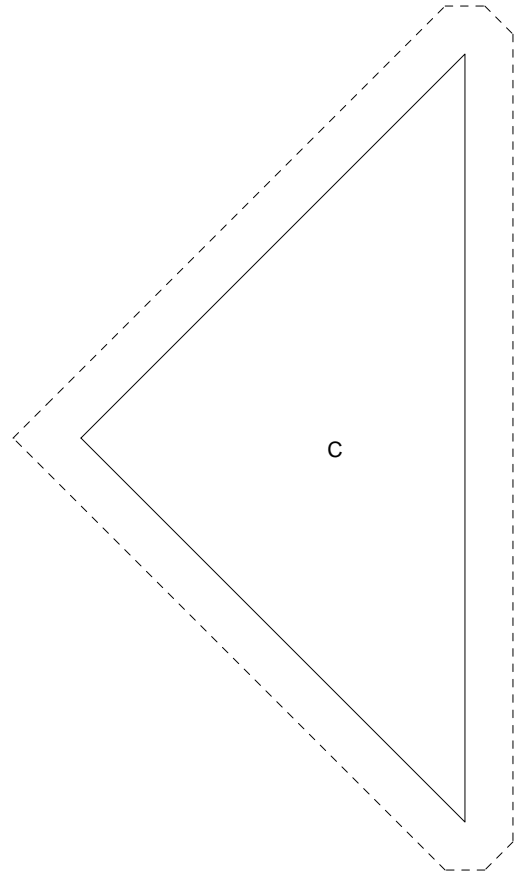
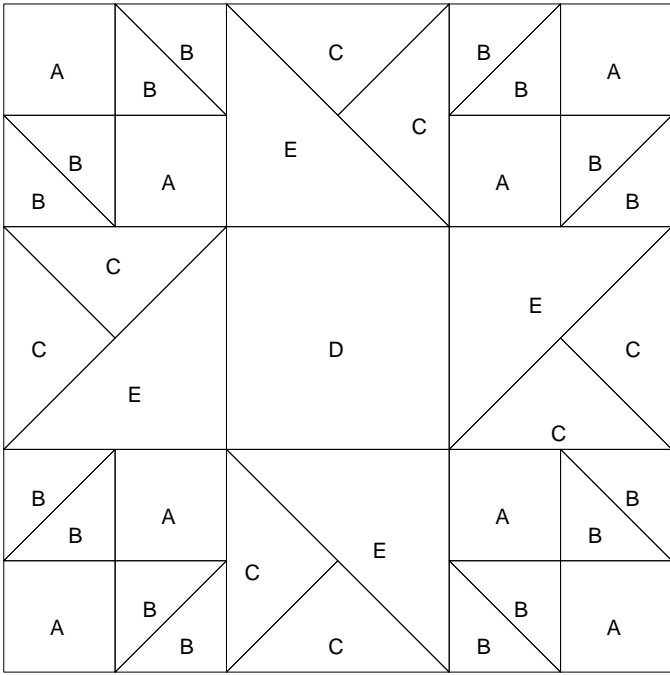

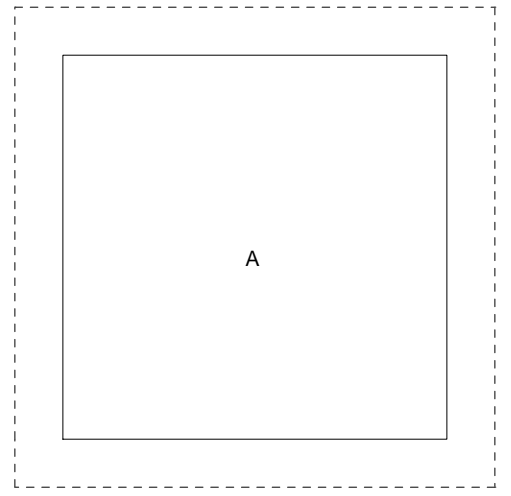
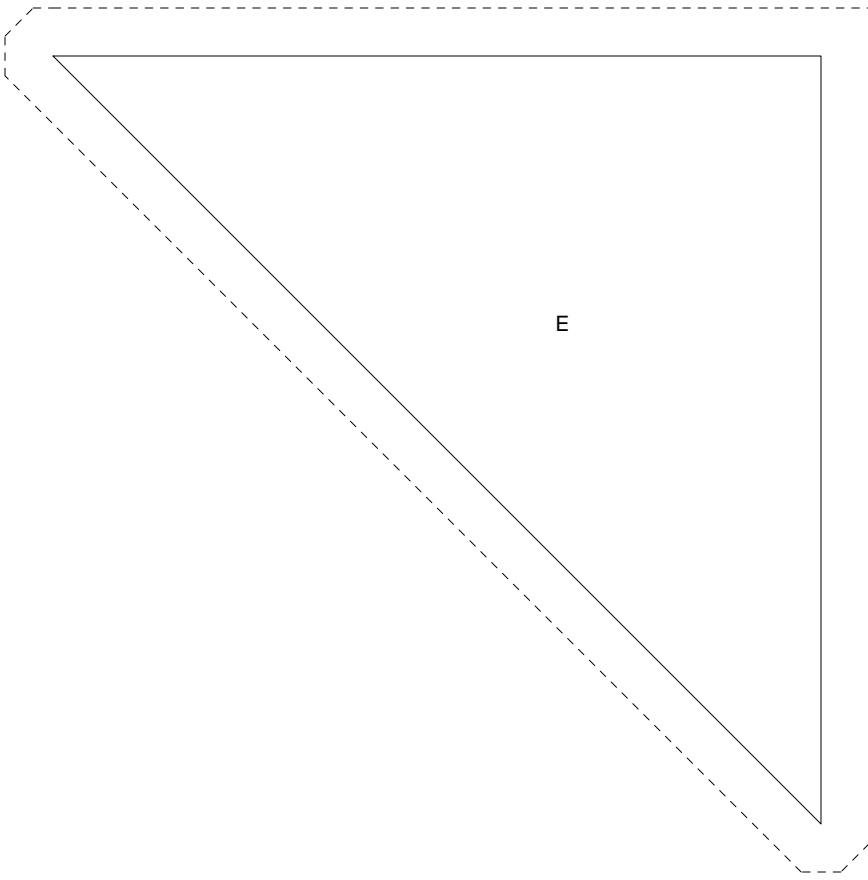

# Sunflower

Pattern for 12.00x12.00 block  
Key Block (1/5 actual size)

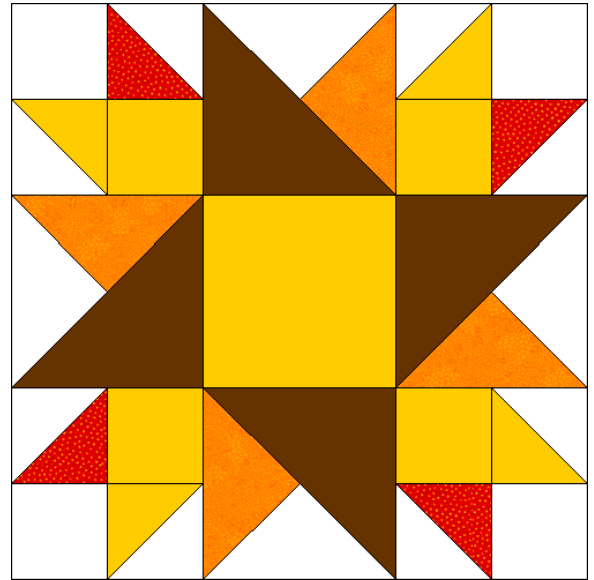
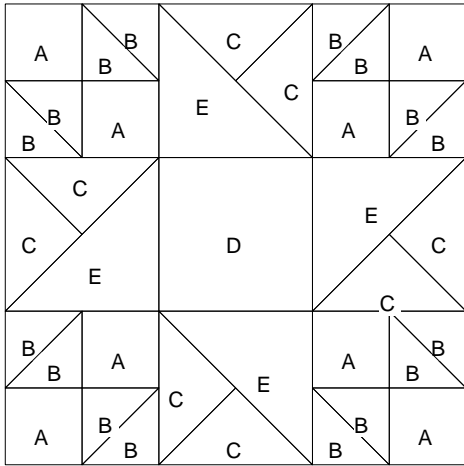

## Cutting Diagrams

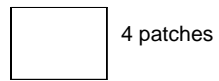
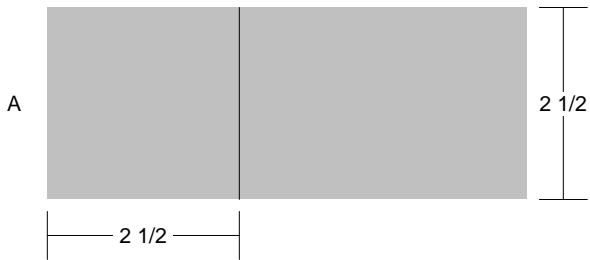

## Patch Count

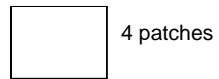
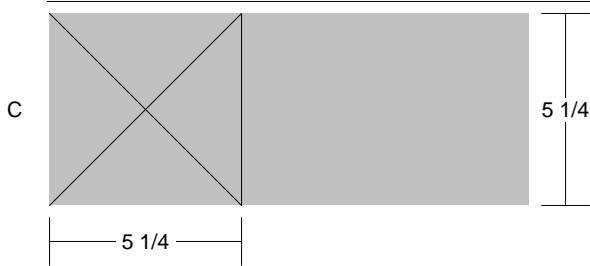
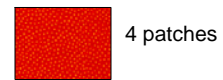
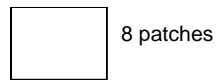
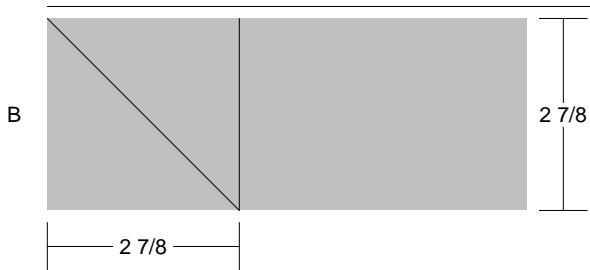

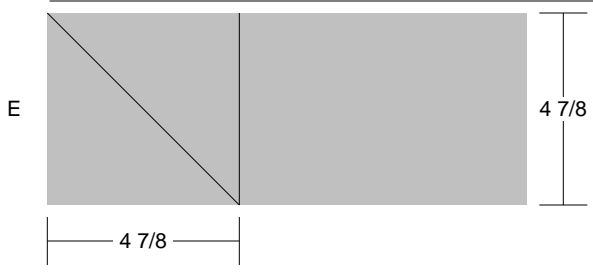
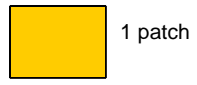
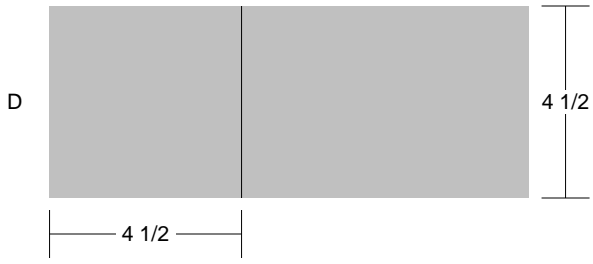

# Wyoming Valley

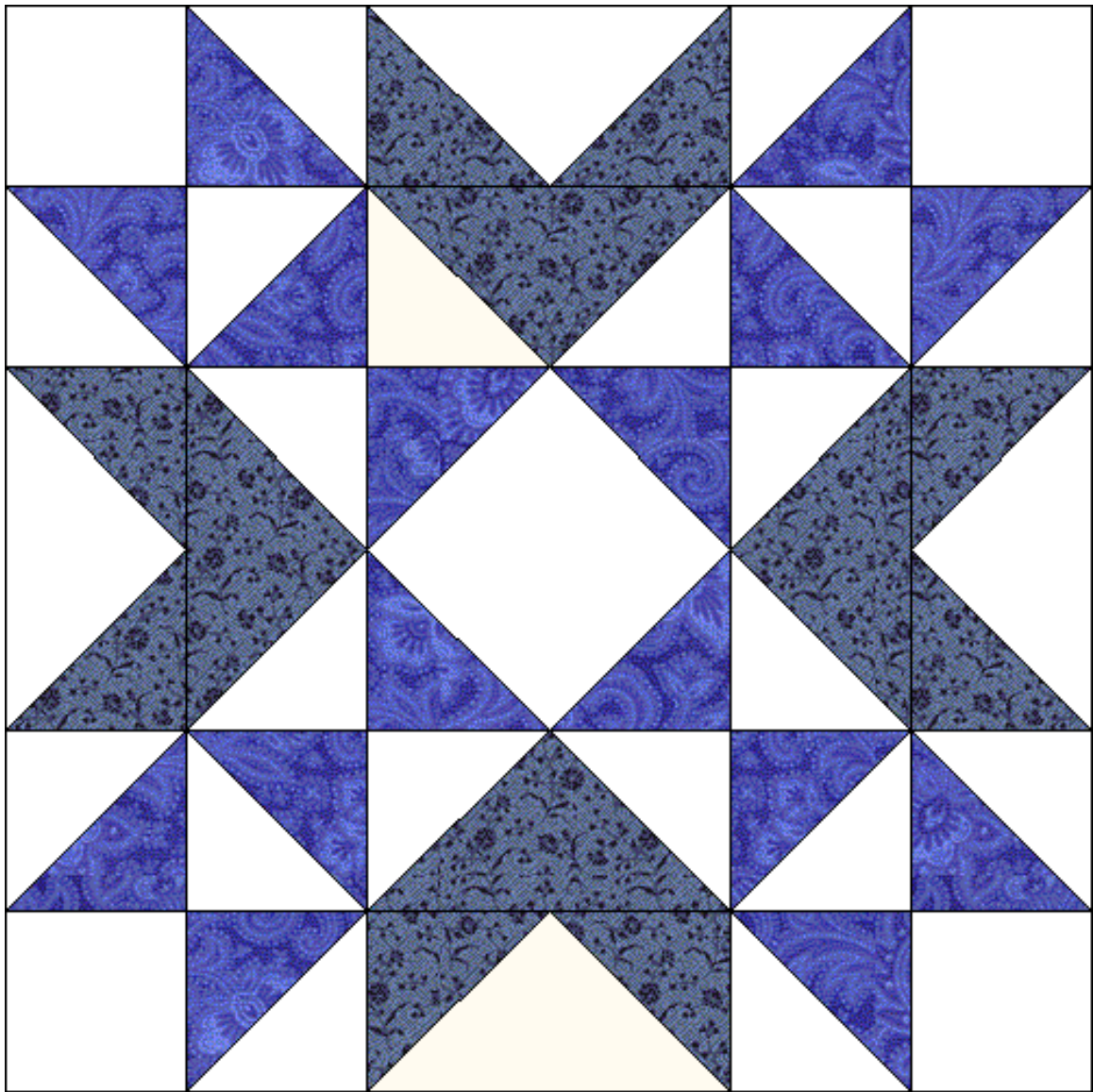

# Wyoming Valley

Pattern for 12.00x12.00 block  
Key Block (1/5 actual size)

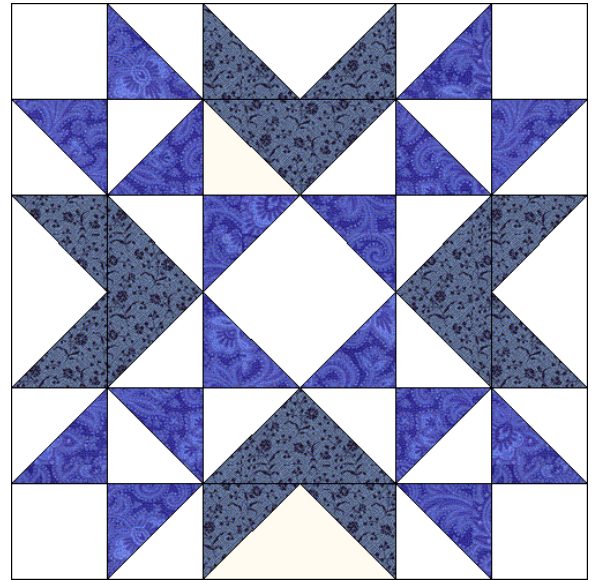
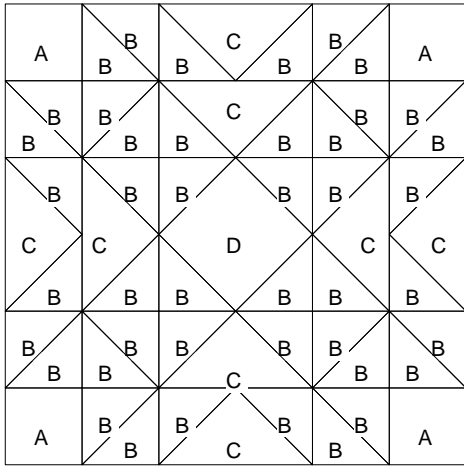

## Cutting Diagrams

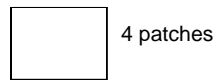
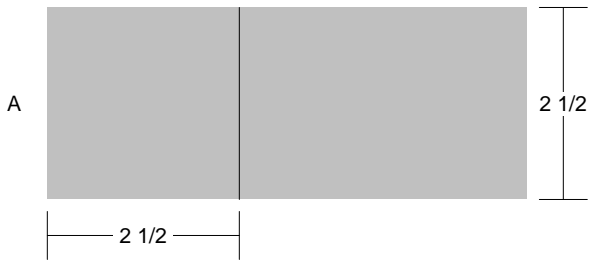

## Patch Count

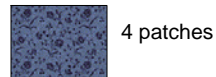
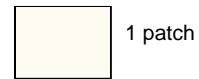
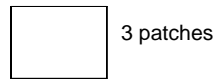
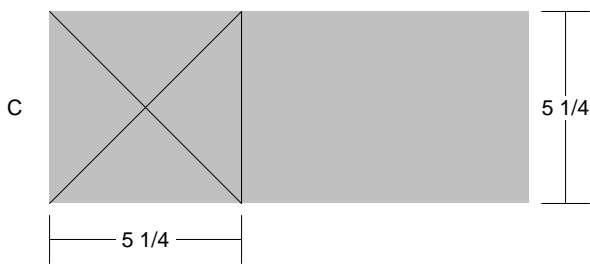
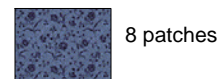
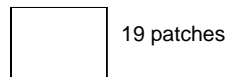
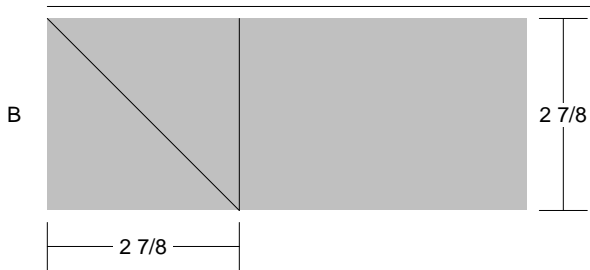

D



1 patch

# Wyoming Valley

Pattern for 12.00x12.00 block  
Key Block (29/100 actual size)

