

# Roses and Tulips

*For Valentine's Day*

from Your Quilting Friends at  
[www.How-to-Quilt.com](http://www.How-to-Quilt.com)



Rosebud

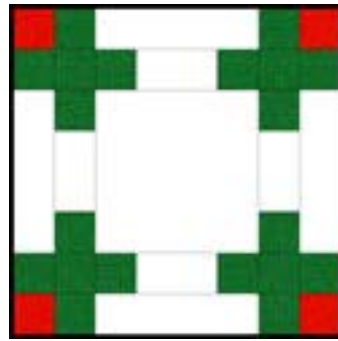

The Rosebud

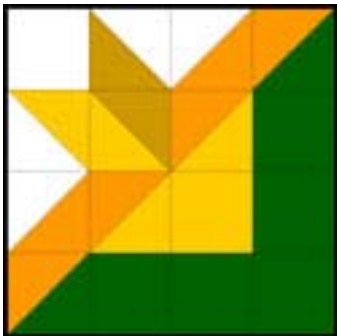

Tulip

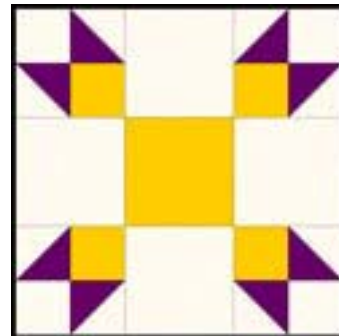

Tulip Lady Fingers

# Rosebud

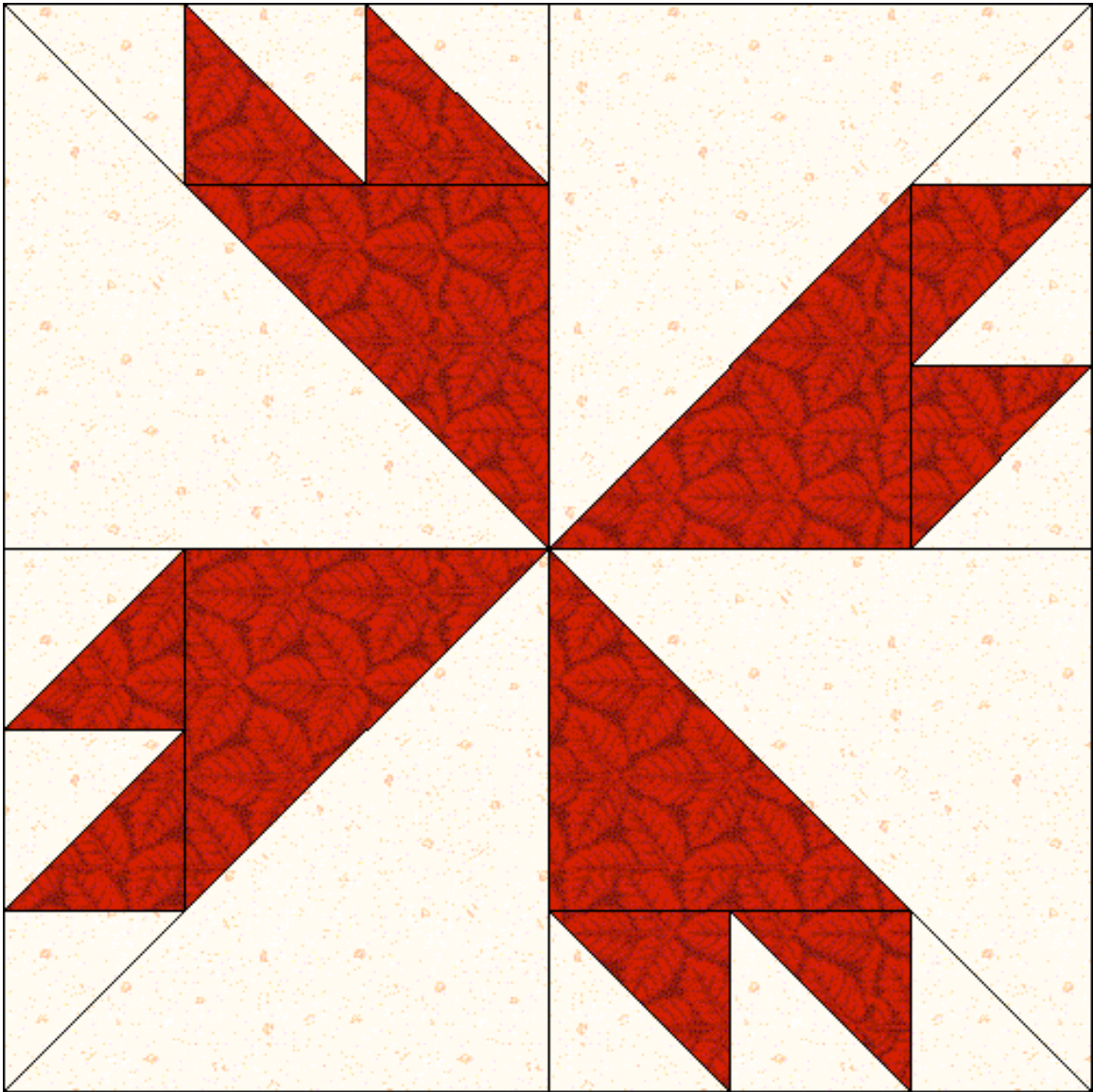

# Rosebud

Pattern for 18.00x18.00 block  
Key Block (9/50 actual size)

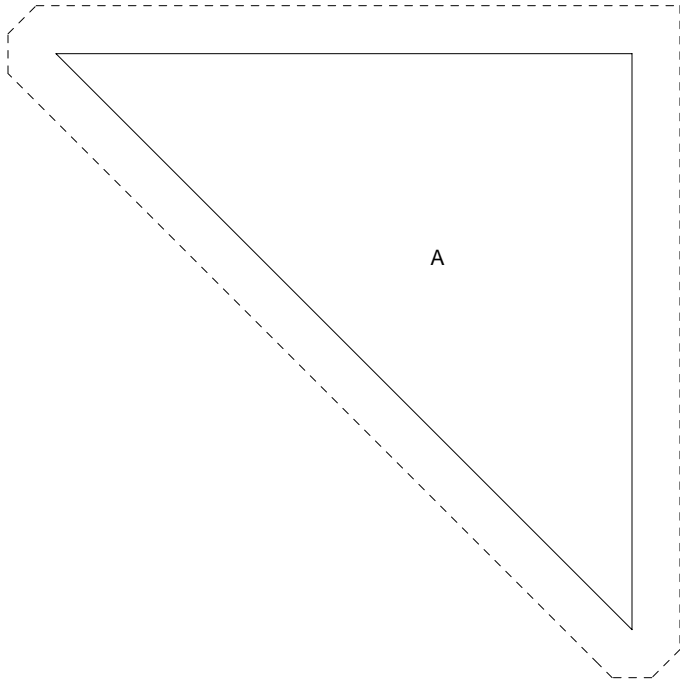
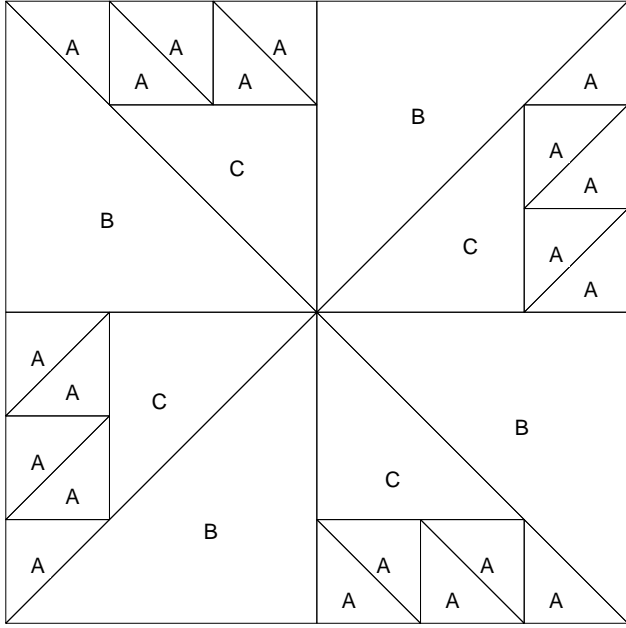

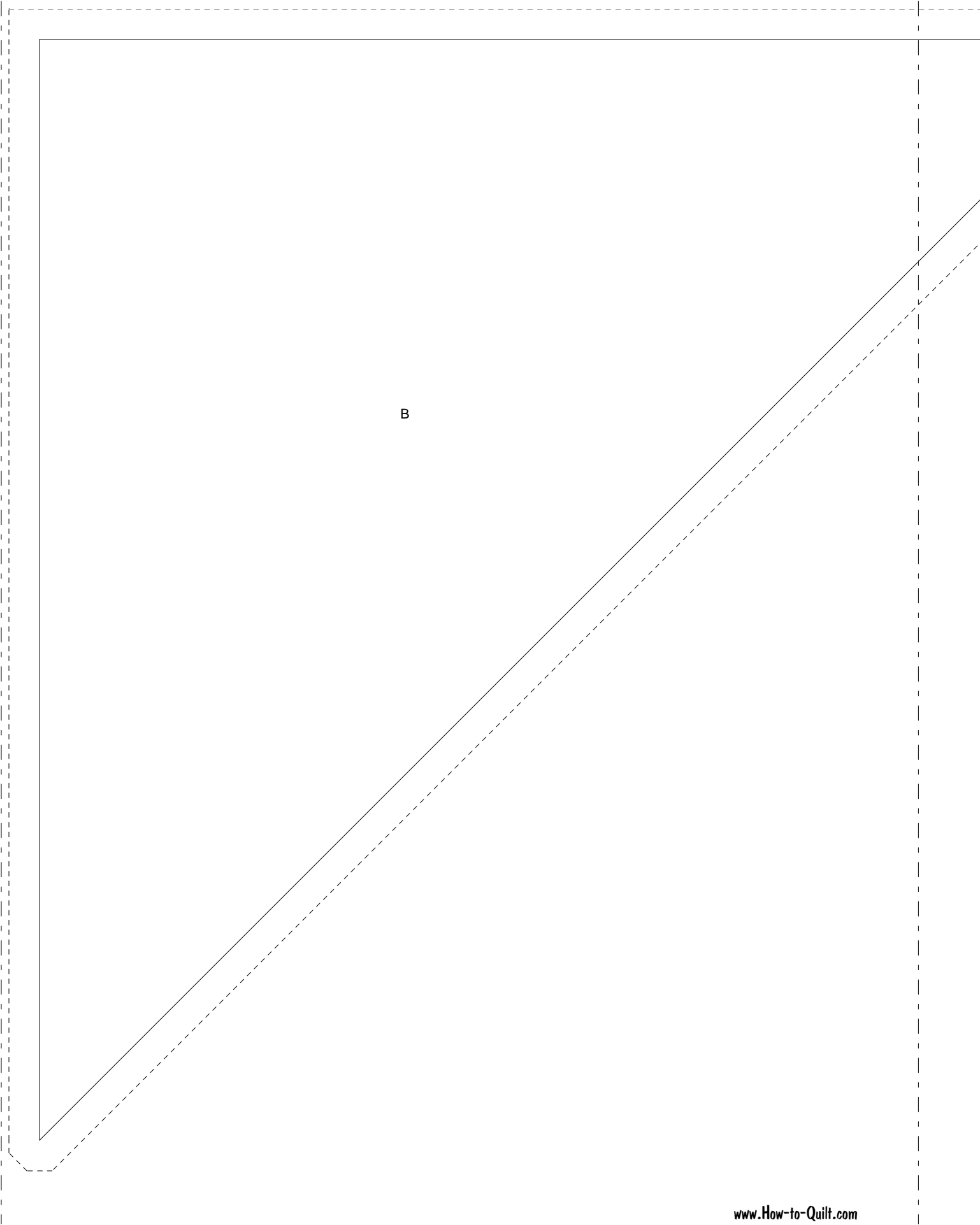

B



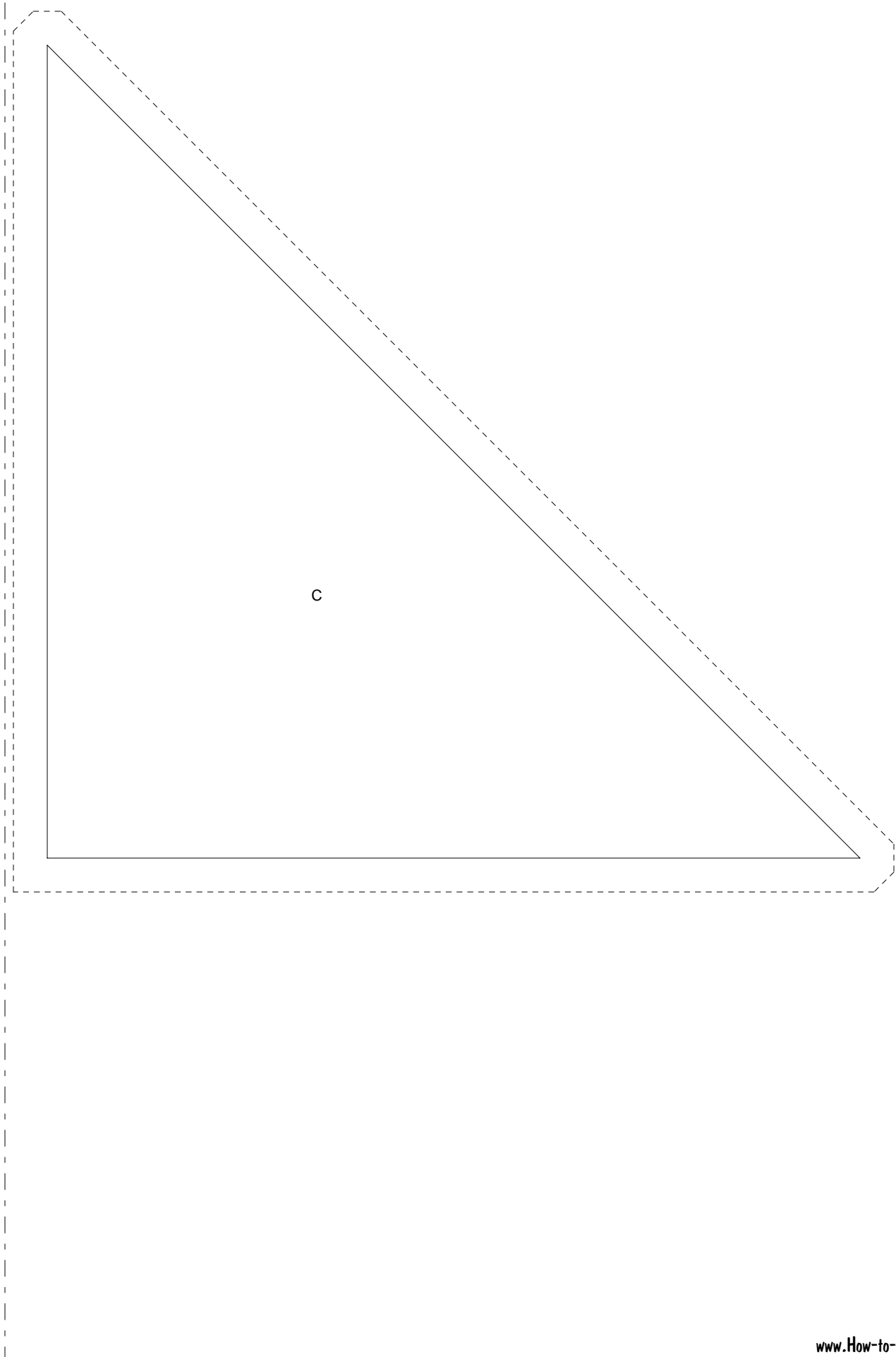

# Rosebud

Pattern for 18.00x18.00 block  
Key Block (13/100 actual size)

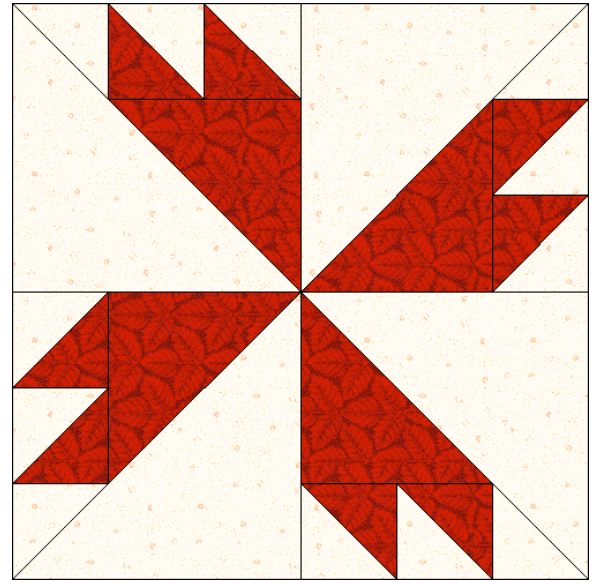
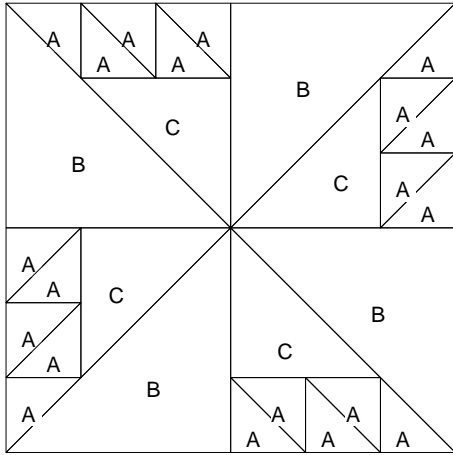

## Cutting Diagrams

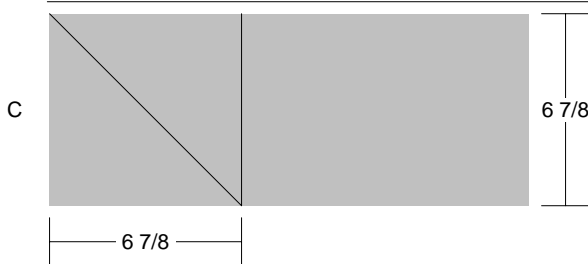
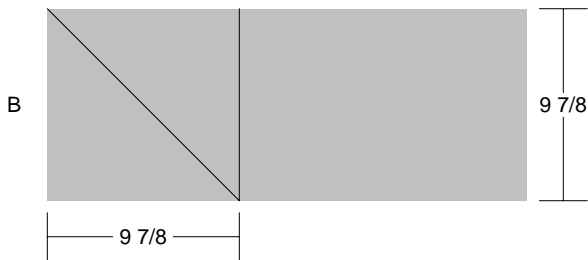
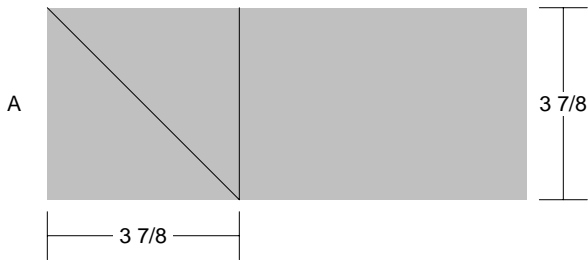

# The Rosebud

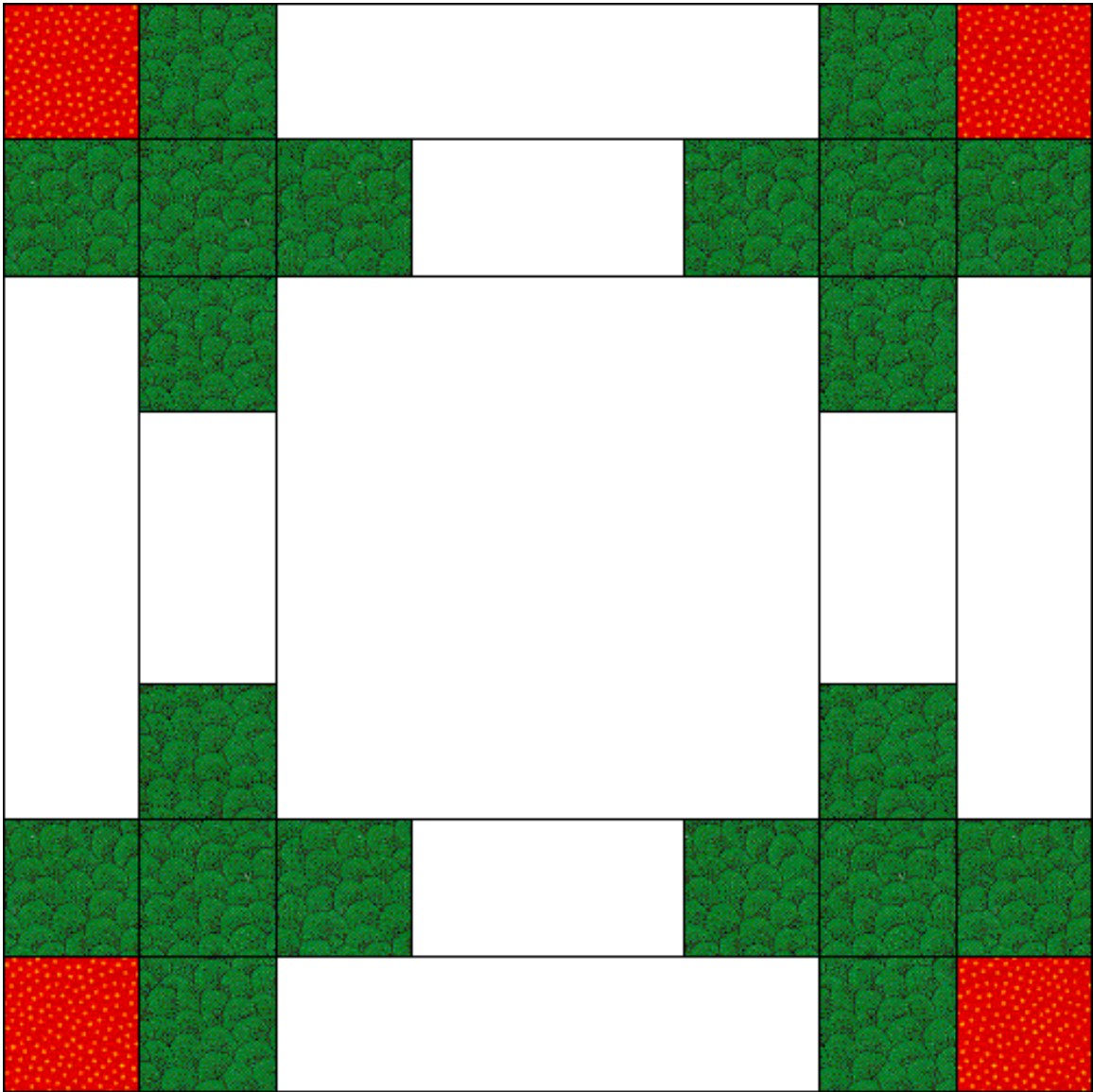

# The Rosebud

Pattern for 18.00x18.00 block  
Key Block (9/50 actual size)

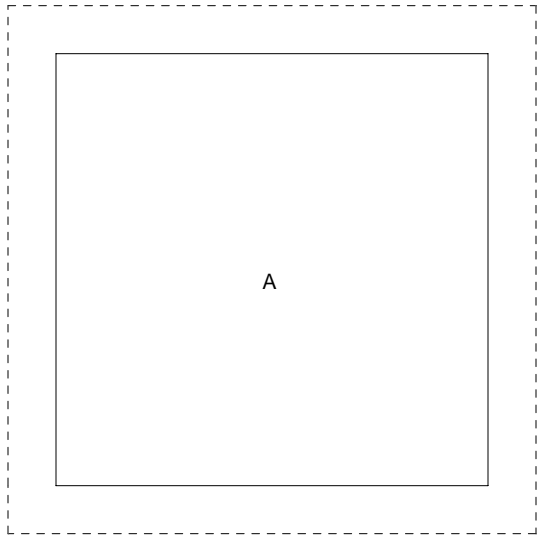
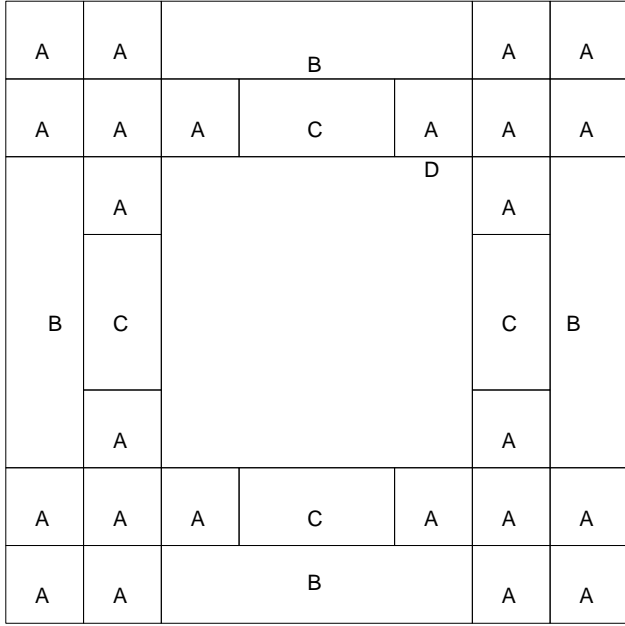

D

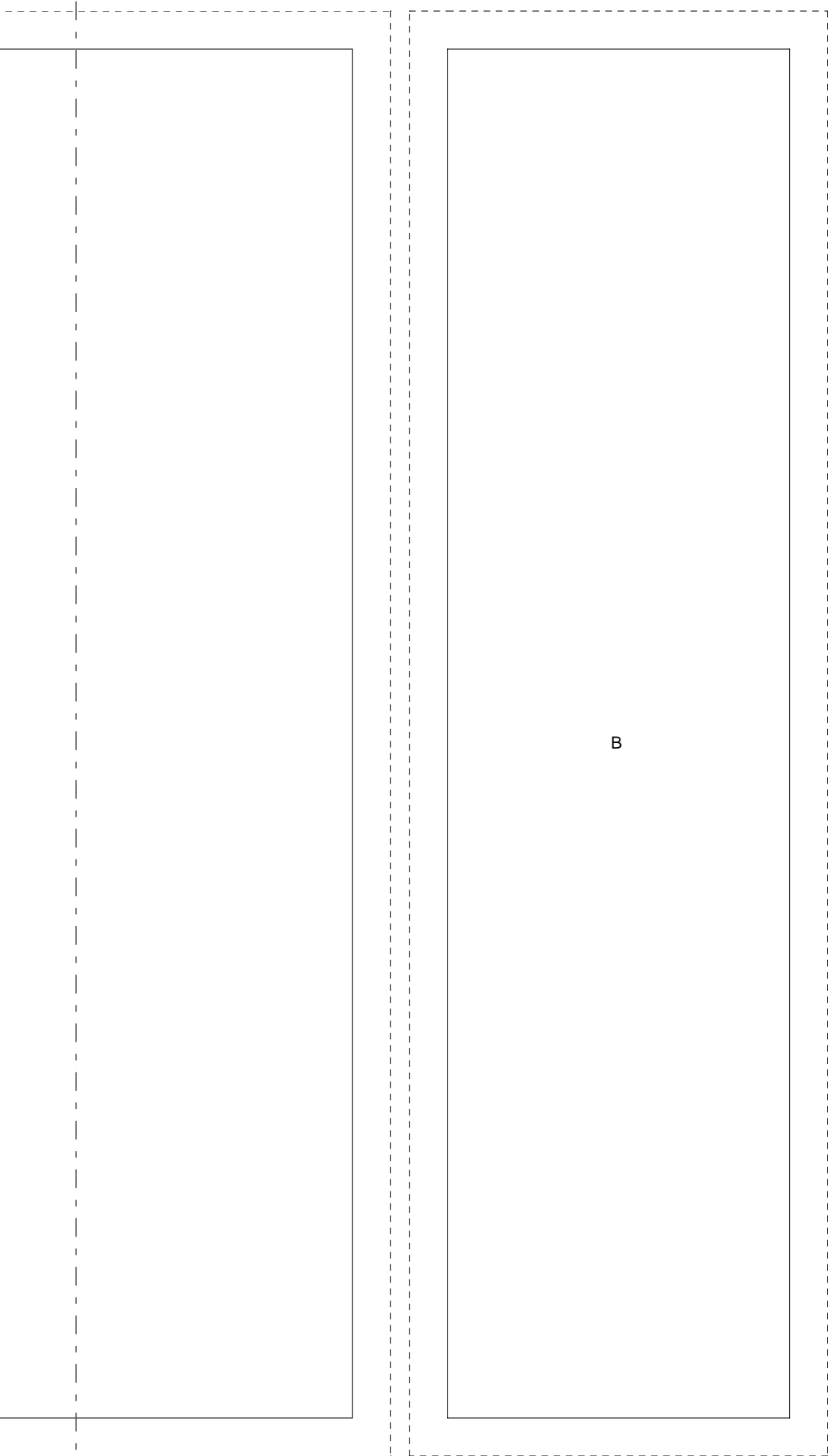

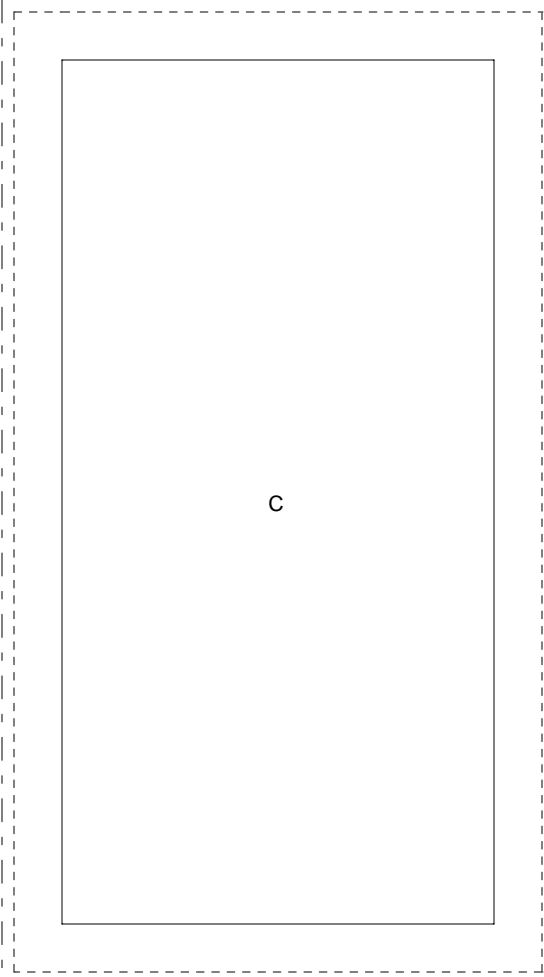

C

# The Rosebud

Pattern for 18.00x18.00 block  
Key Block (13/100 actual size)

A	A	B			A	A
A	A	A	C	A	A	A
B	A	D			A	B
	C				C	
	A				A	
A	A	A	C	A	A	A
A	A	B			A	A

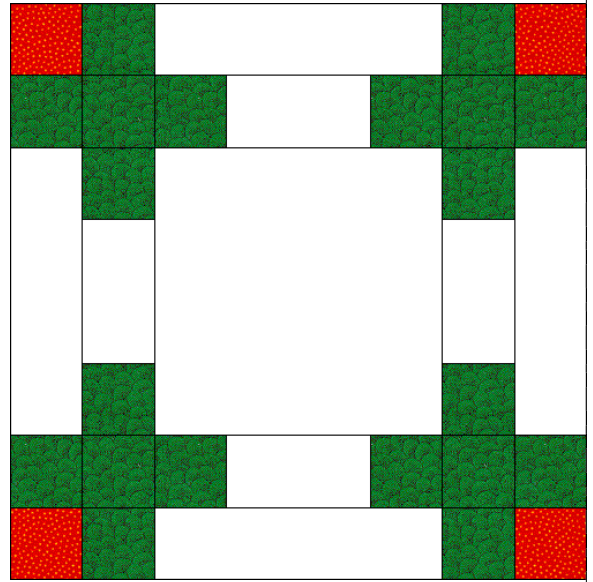

## Cutting Diagrams

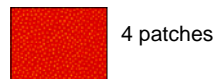

## Patch Count

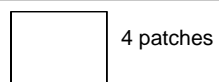
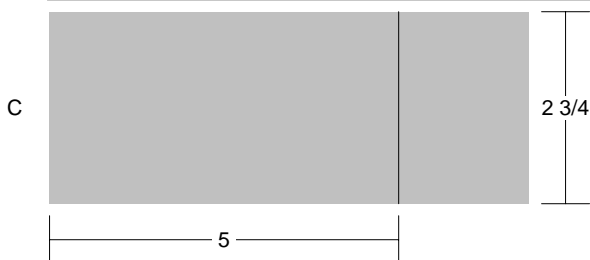
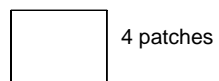
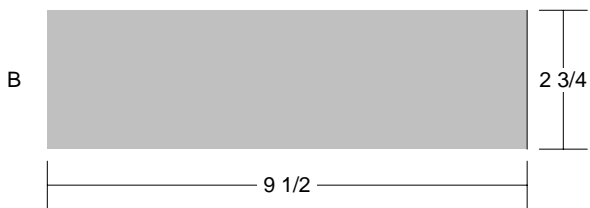
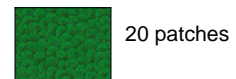

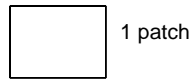
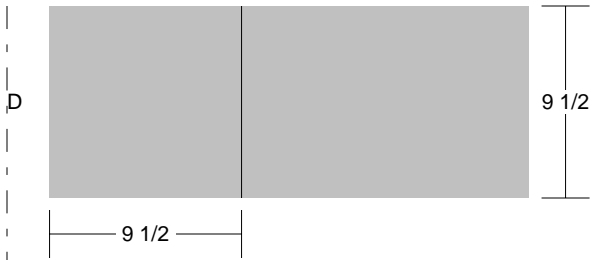

# Tulip

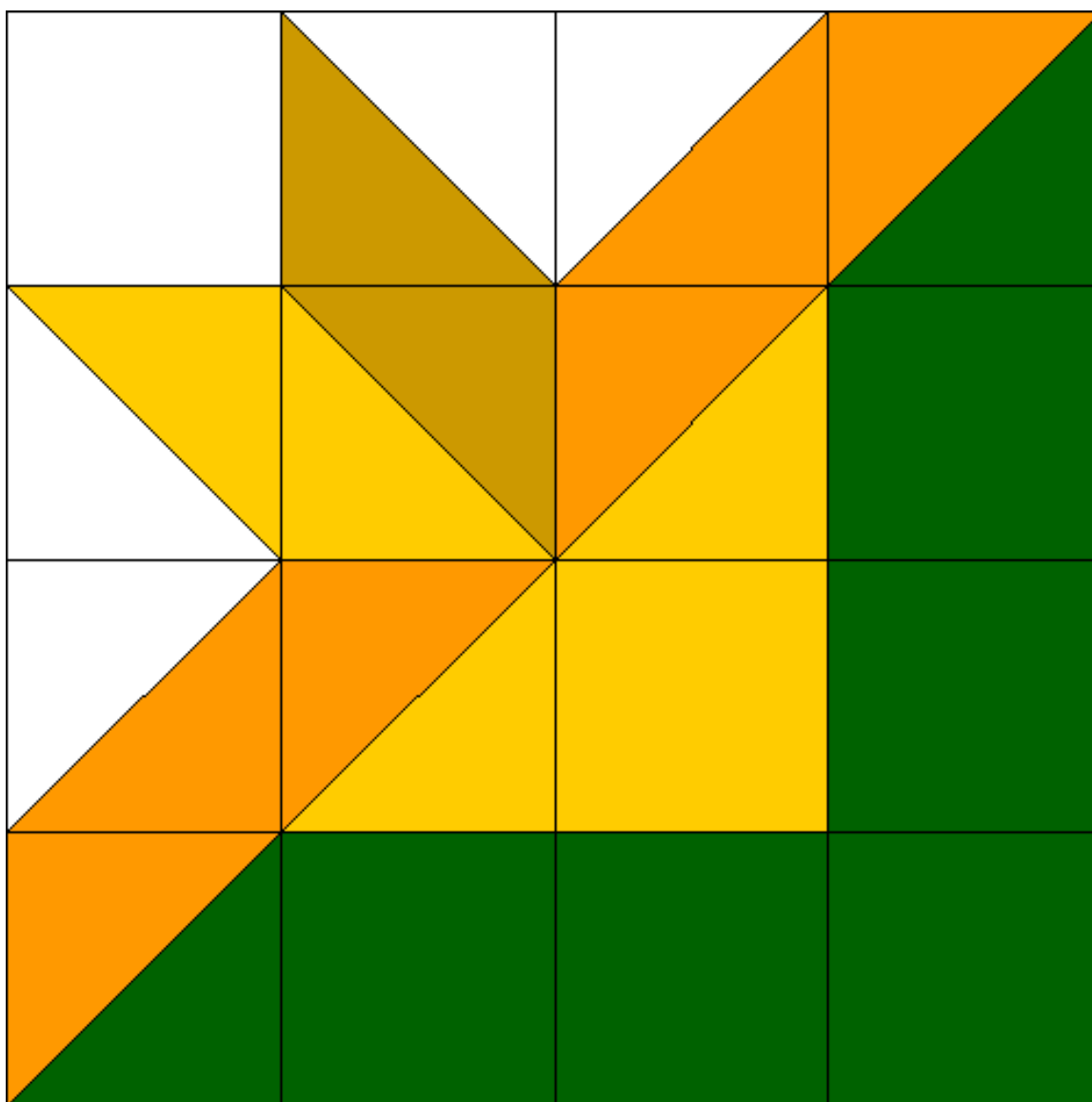

# Tulip

Pattern for 16.00x16.00 block  
Key Block (1/5 actual size)

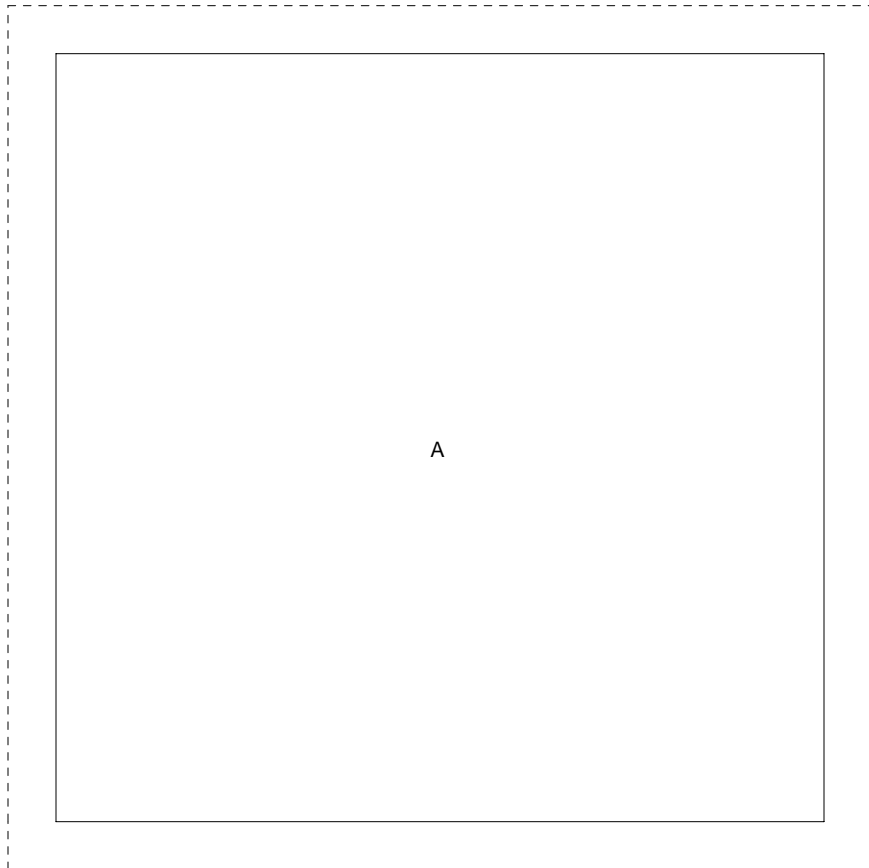
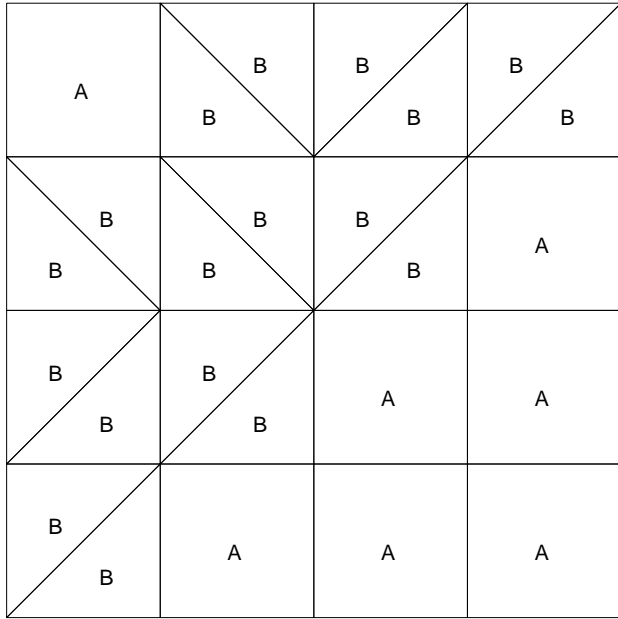

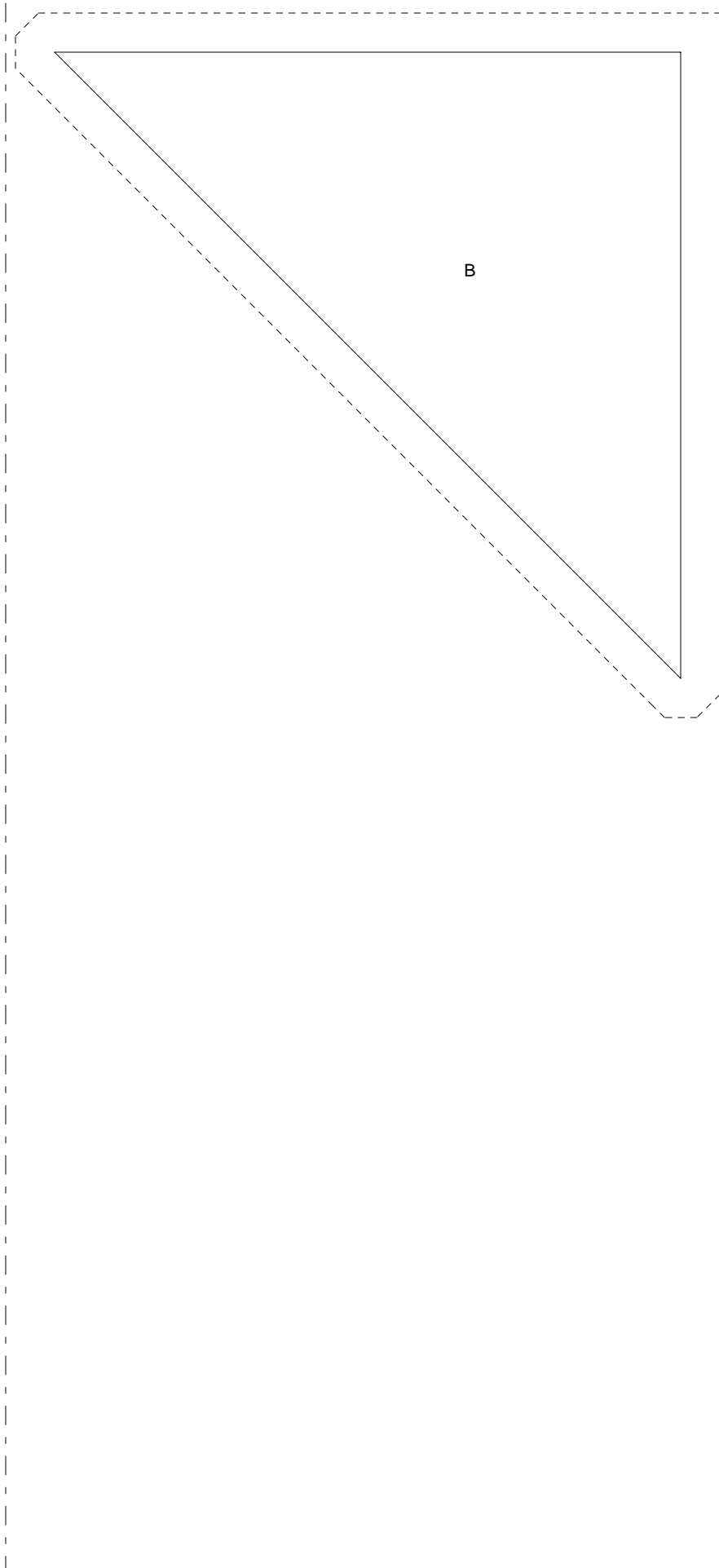

# Tulip

Pattern for 16.00x16.00 block  
Key Block (3/20 actual size)

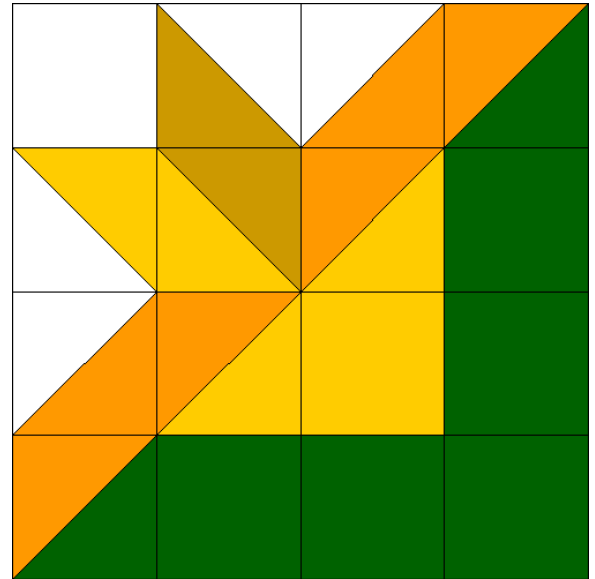
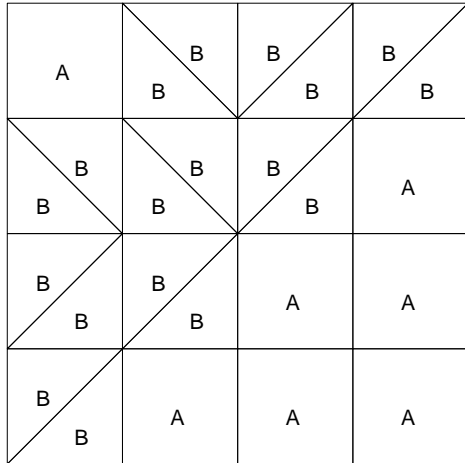

## Cutting Diagrams

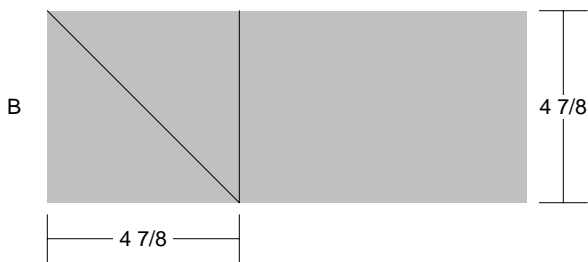
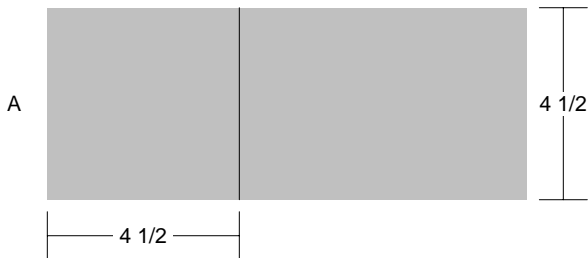

## Patch Count

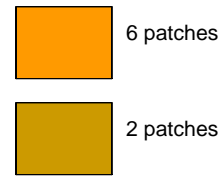
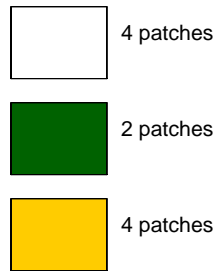
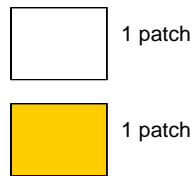

# Tulip Lady Fingers

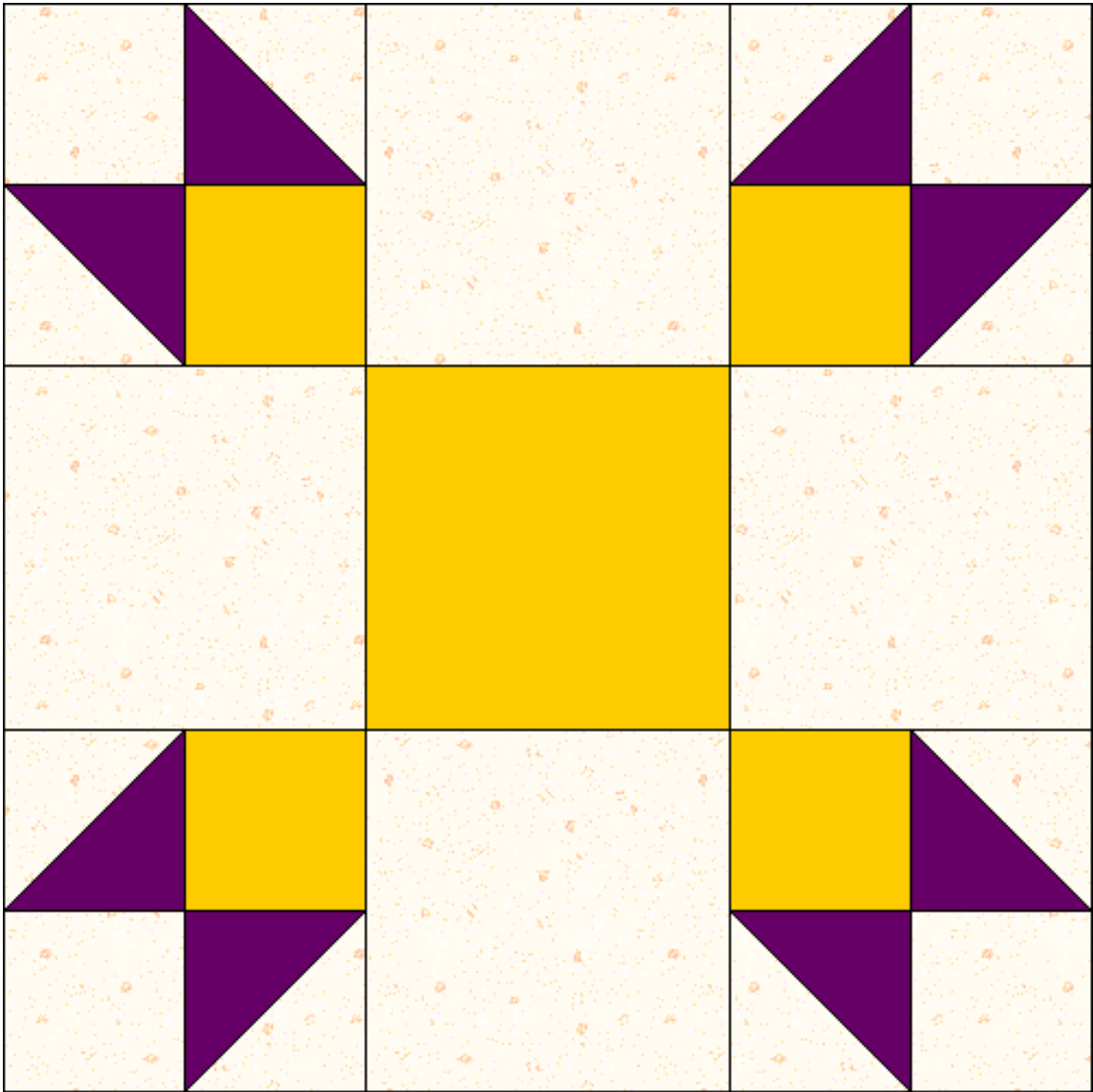

# Tulip Lady Fingers

Pattern for 18.00x18.00 block  
Key Block (9/50 actual size)

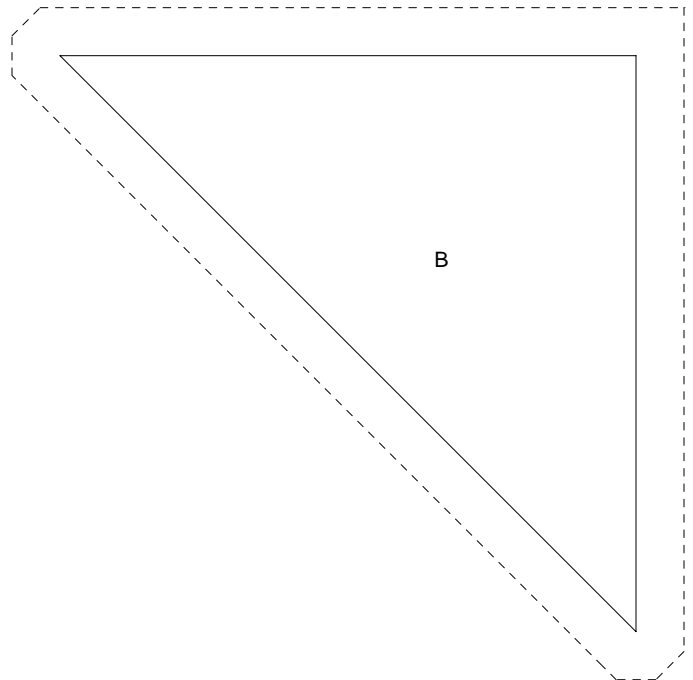
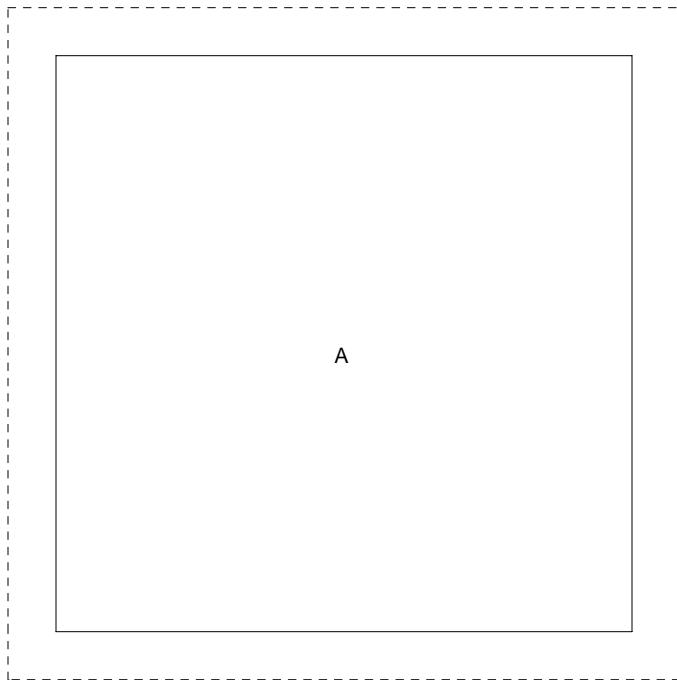
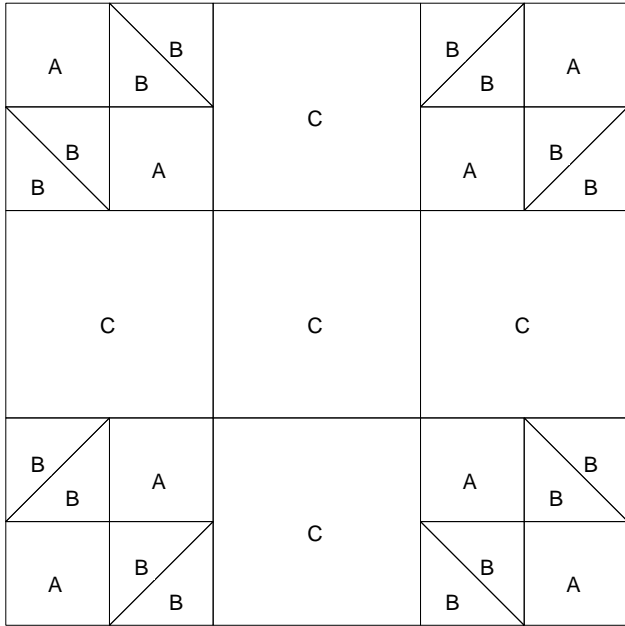

c

# Tulip Lady Fingers

Pattern for 18.00x18.00 block  
Key Block (13/100 actual size)

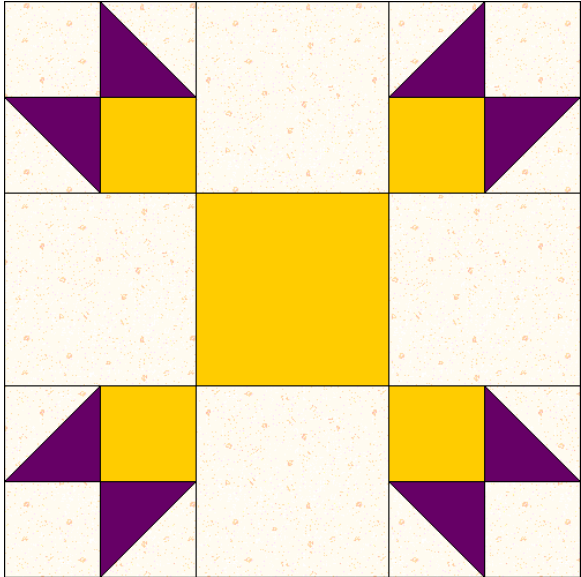
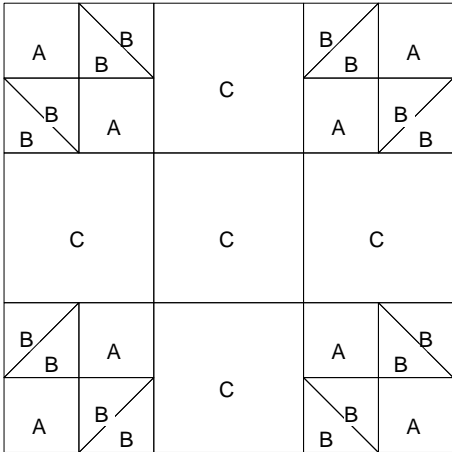

### Cutting Diagrams

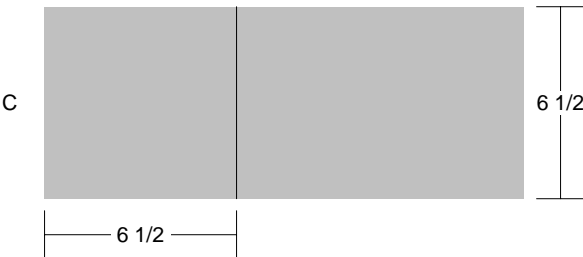
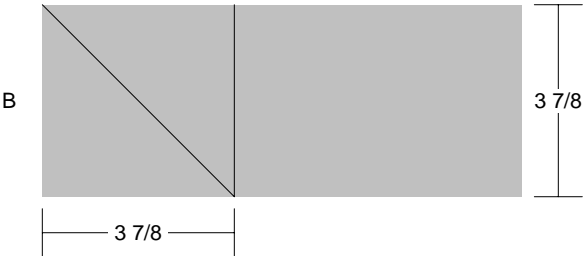

### Patch Count

