

January How To Quilt Patterns

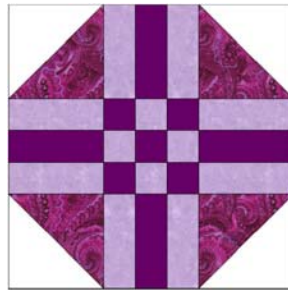

Ladies' Delight



Far West

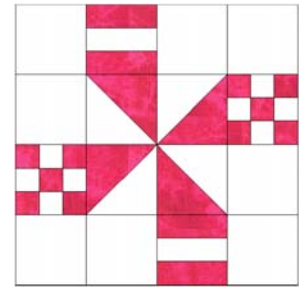

Lady of the White House

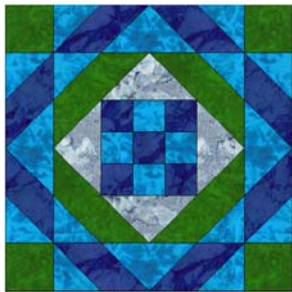

Afternoon Shadows

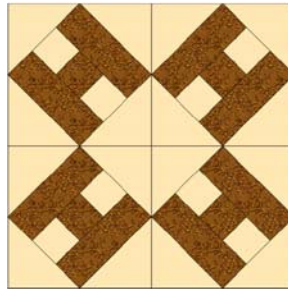

4H Club Quilt

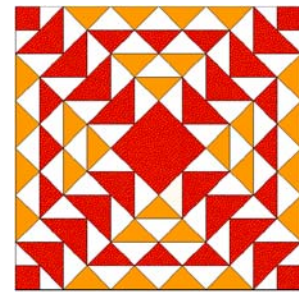

Chinese Holiday

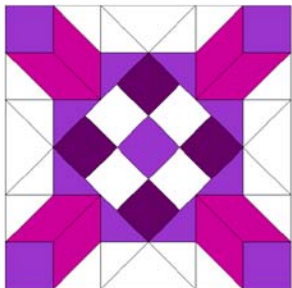

Hopes and

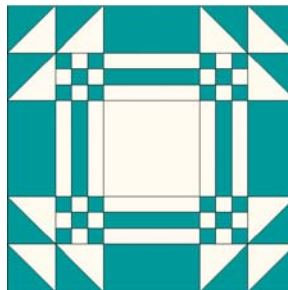

Missouri Puzzle

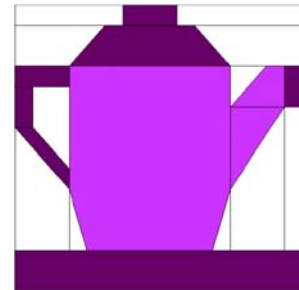

Teapot

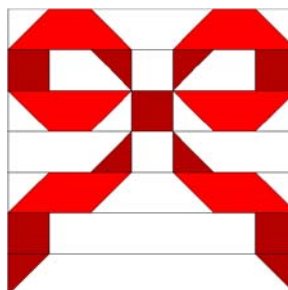

Ribbon Bow

4H Club Quilt

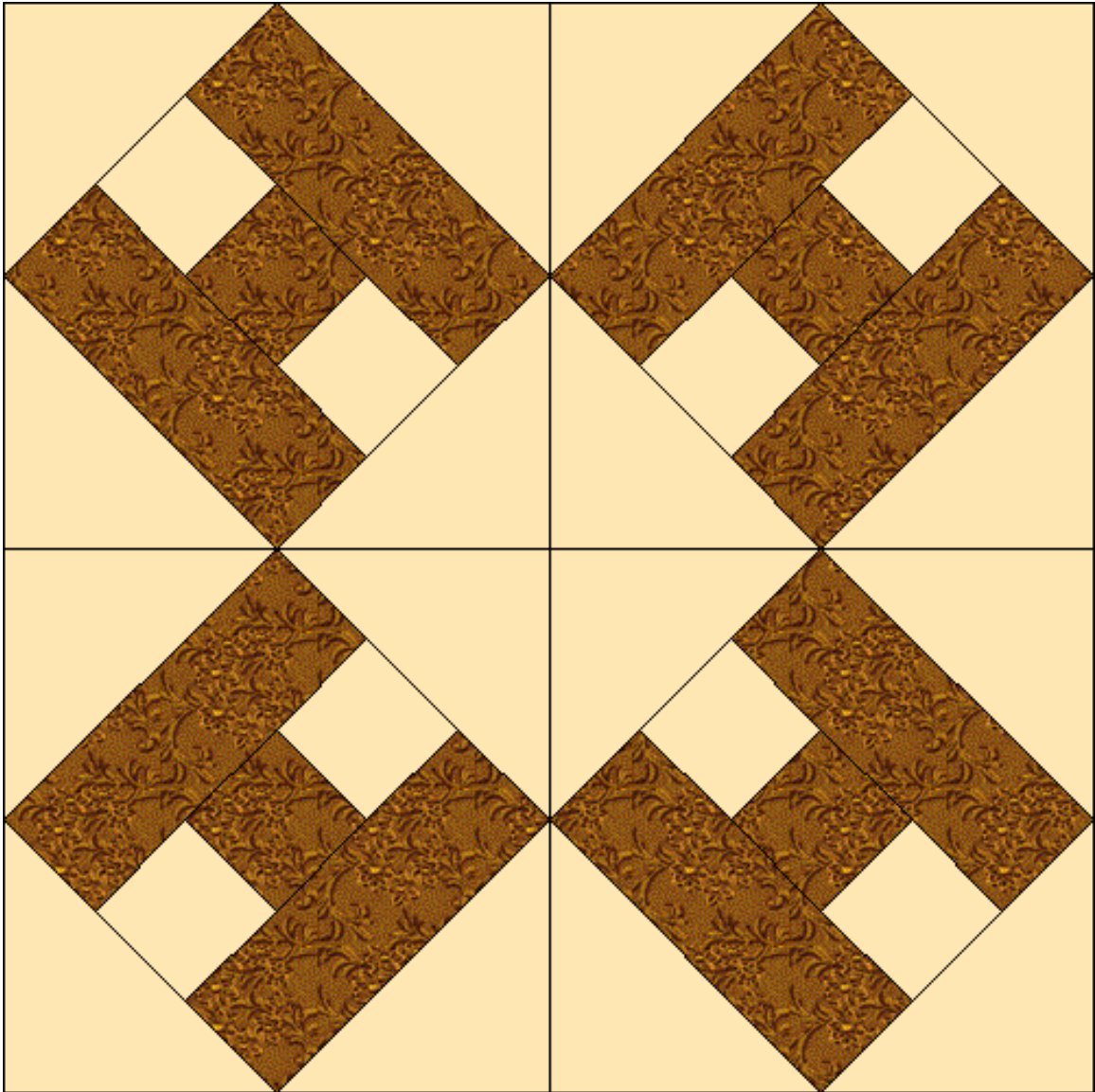

4H Club Quilt
 Pattern for 9.00x9.00 block
 Key Block (27/100 actual size)

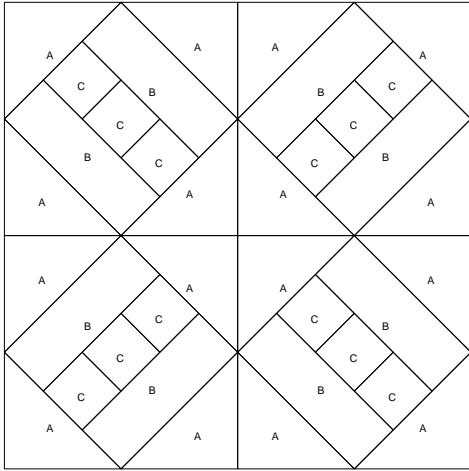

Cutting Diagrams

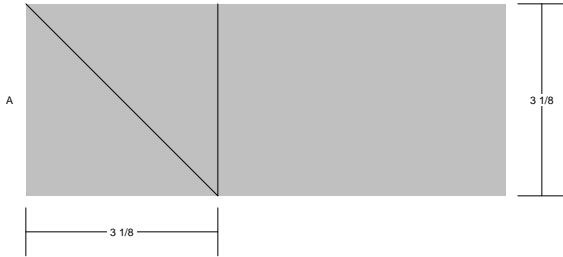

Patch Count

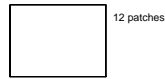
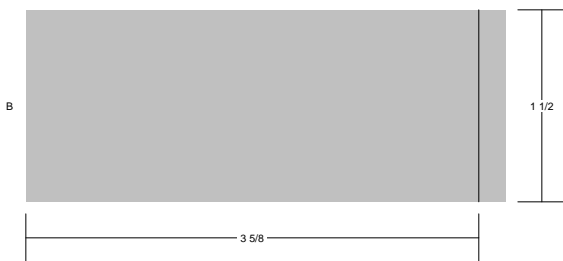

4H Club Quilt
Pattern for 9.00x9.00 block
Key Block (19/50 actual size)

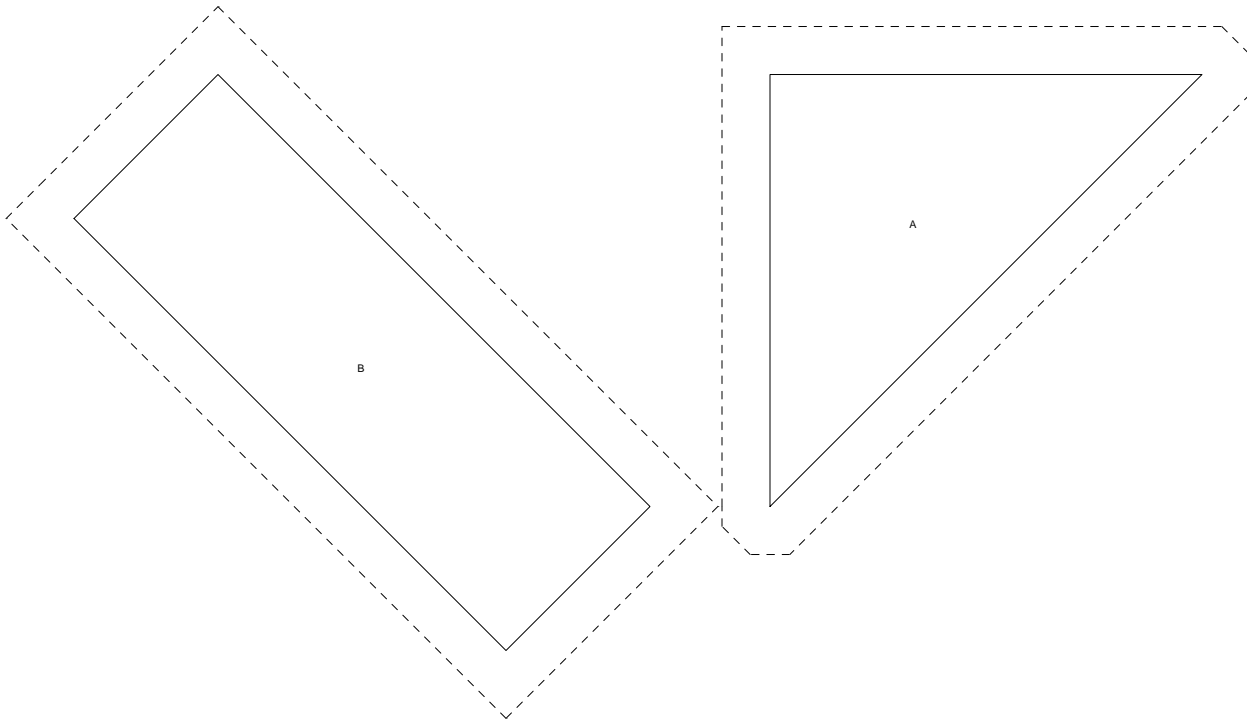
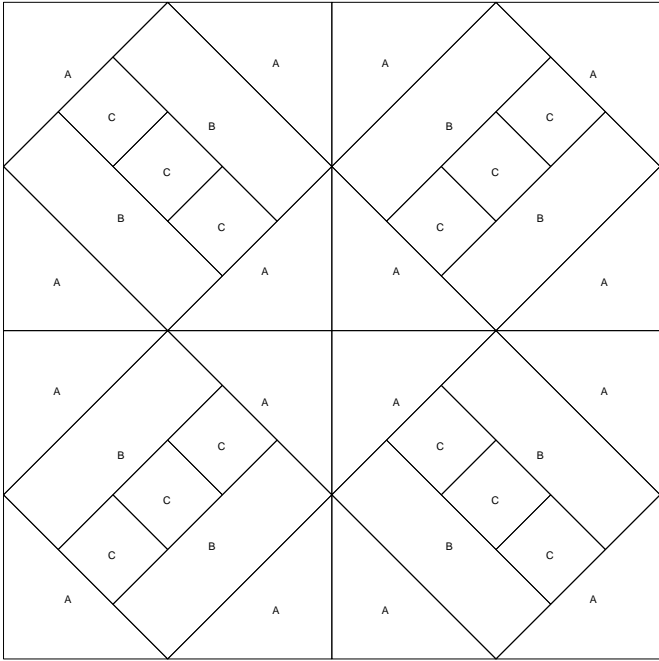

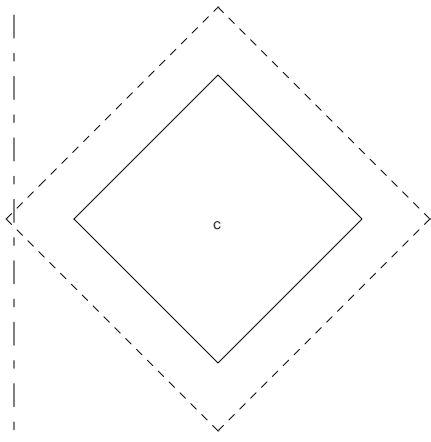

c

Afternoon Shadows

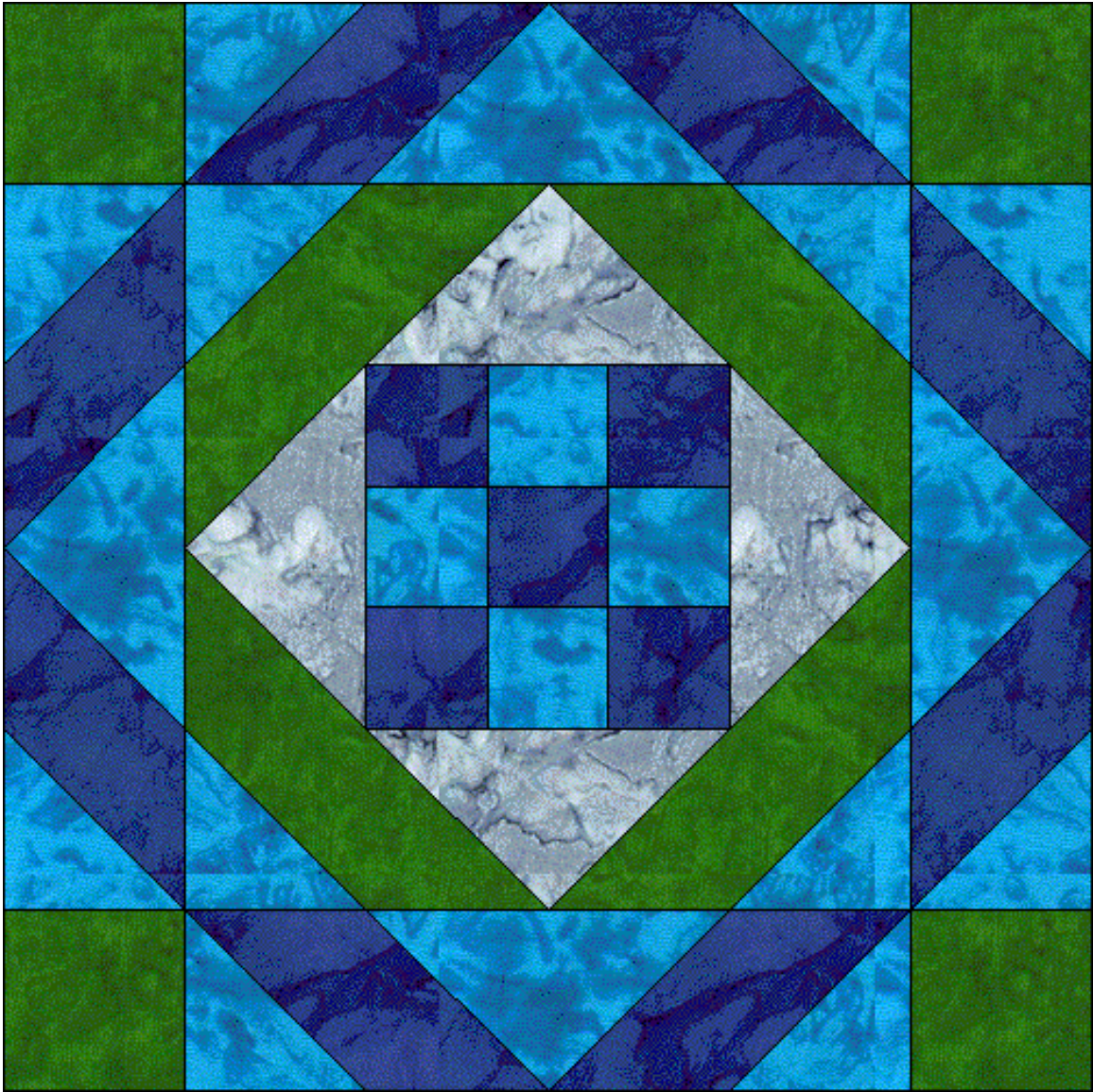

Afternoon Shadows

Pattern for 12.00x12.00 block
Key Block (1/5 actual size)

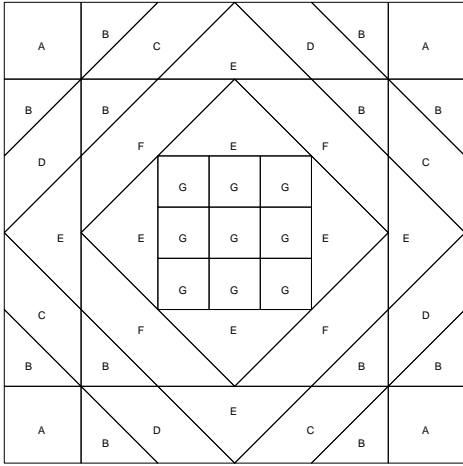

Cutting Diagrams



Patch Count

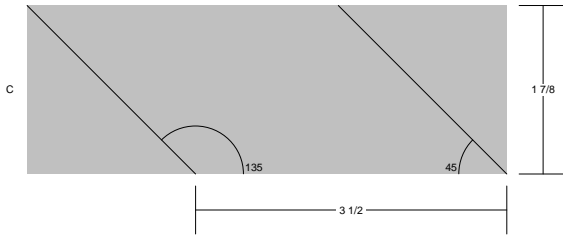
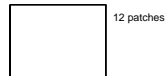
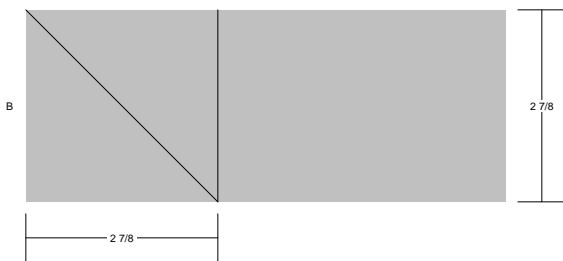

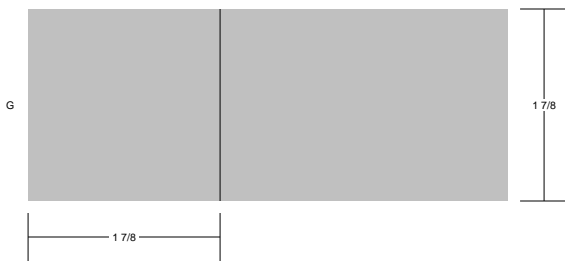
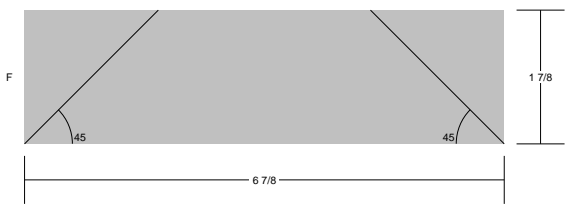
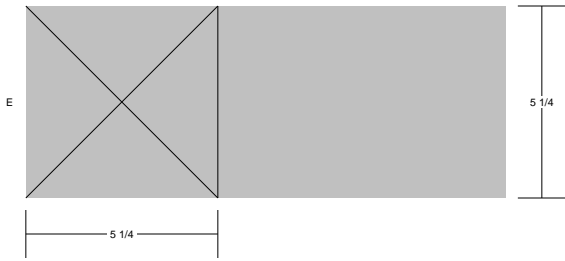
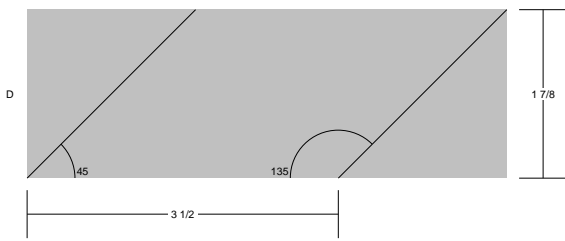

Afternoon Shadows
 Pattern for 12.00x12.00 block
 Key Block (29/100 actual size)

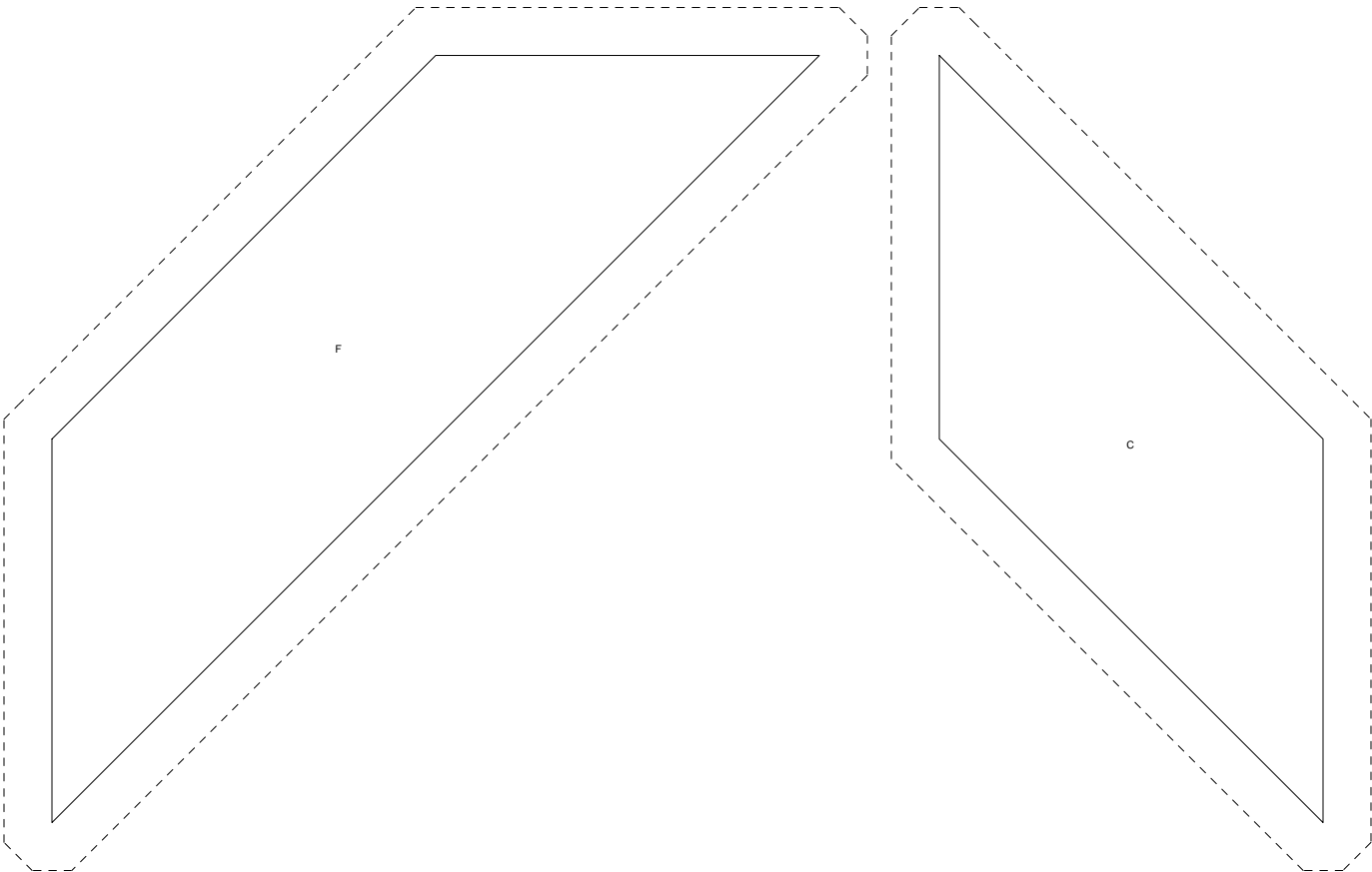
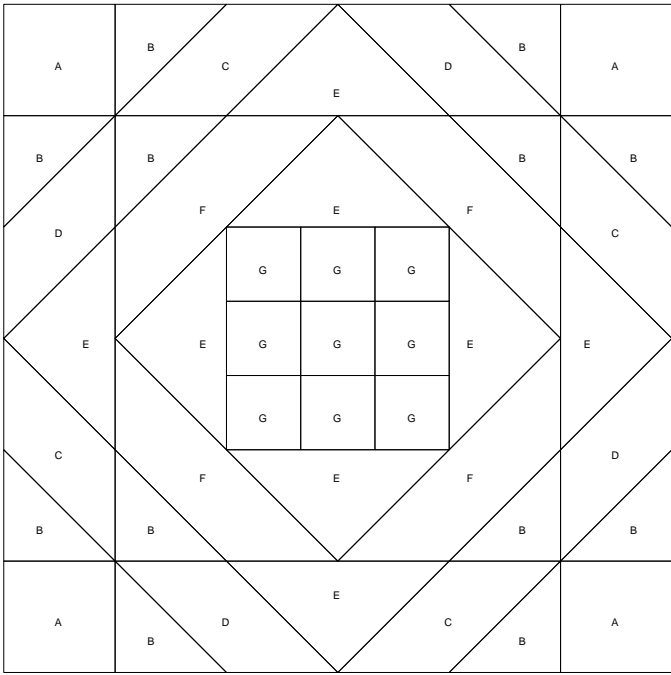

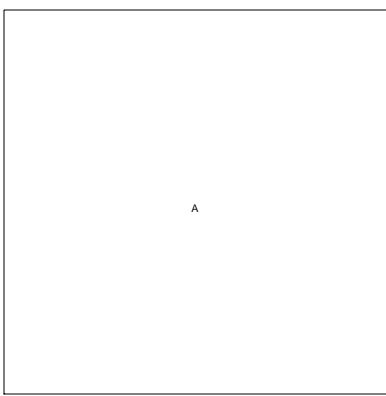
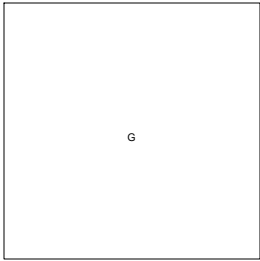
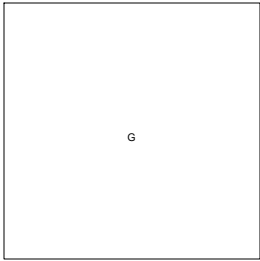
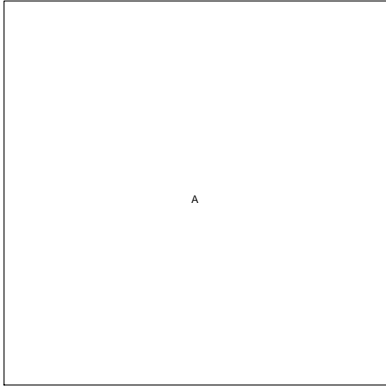
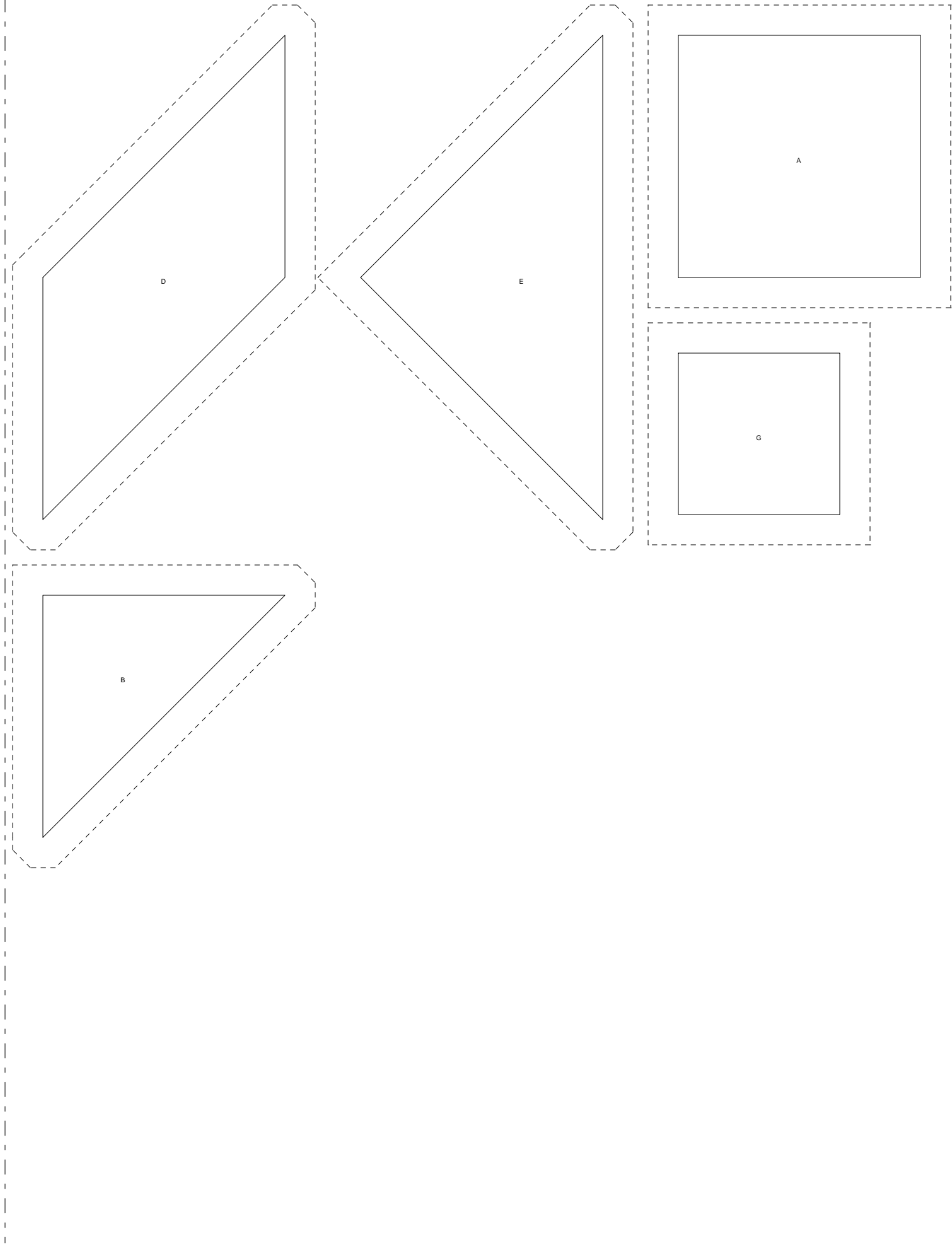

Chinese Holidays

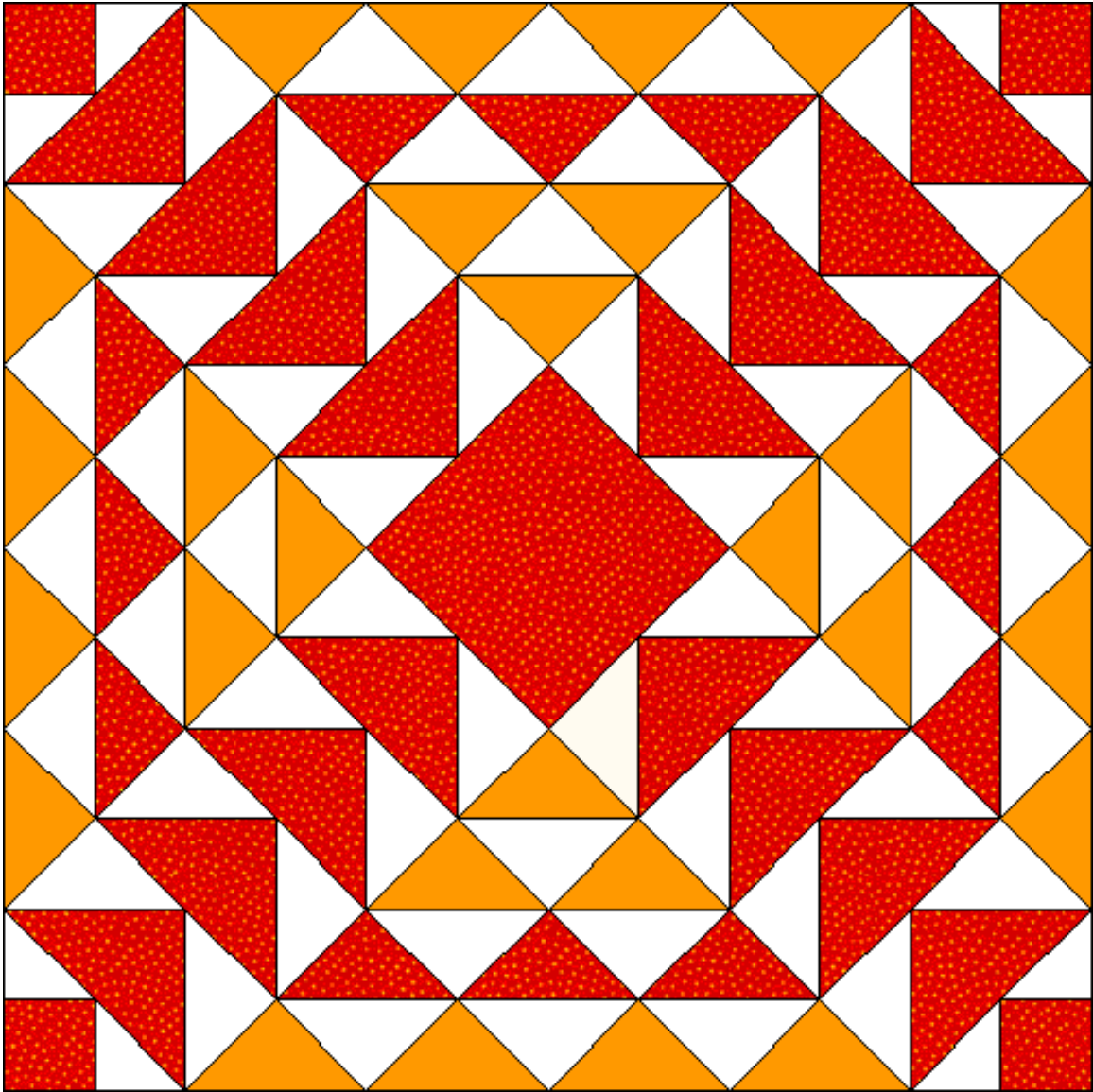

Chinese Holidays
 Pattern for 12.00x12.00 block
 Key Block (1/5 actual size)

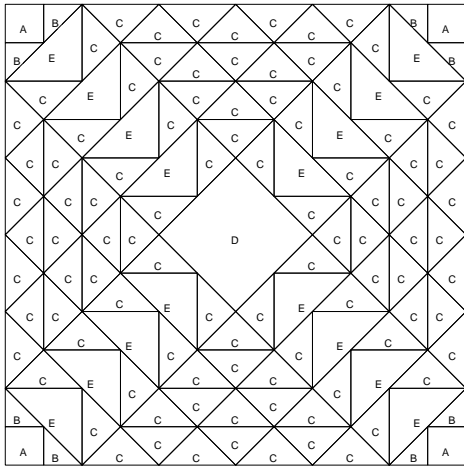

Cutting Diagrams



Patch Count

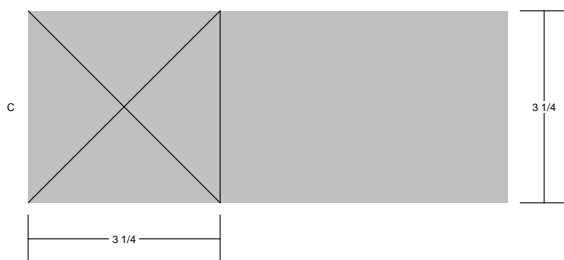
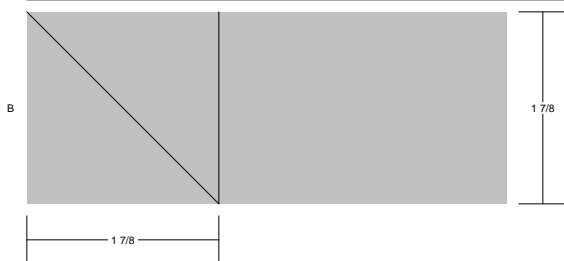

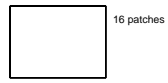
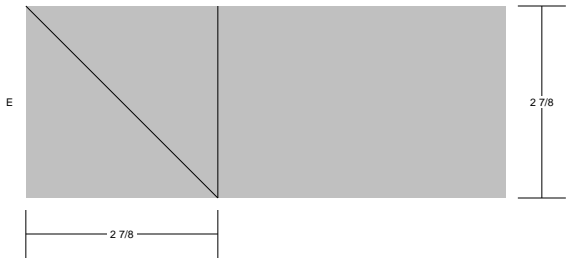

Chinese Holidays
 Pattern for 12.00x12.00 block
 Key Block (29/100 actual size)

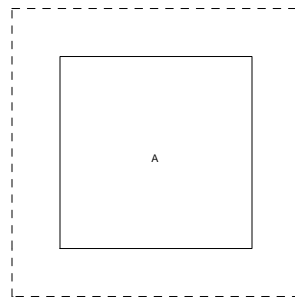
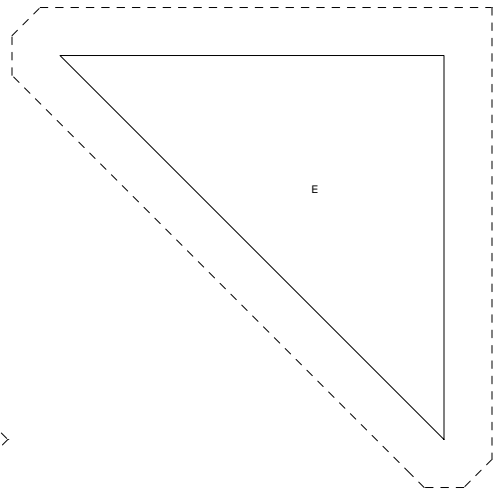
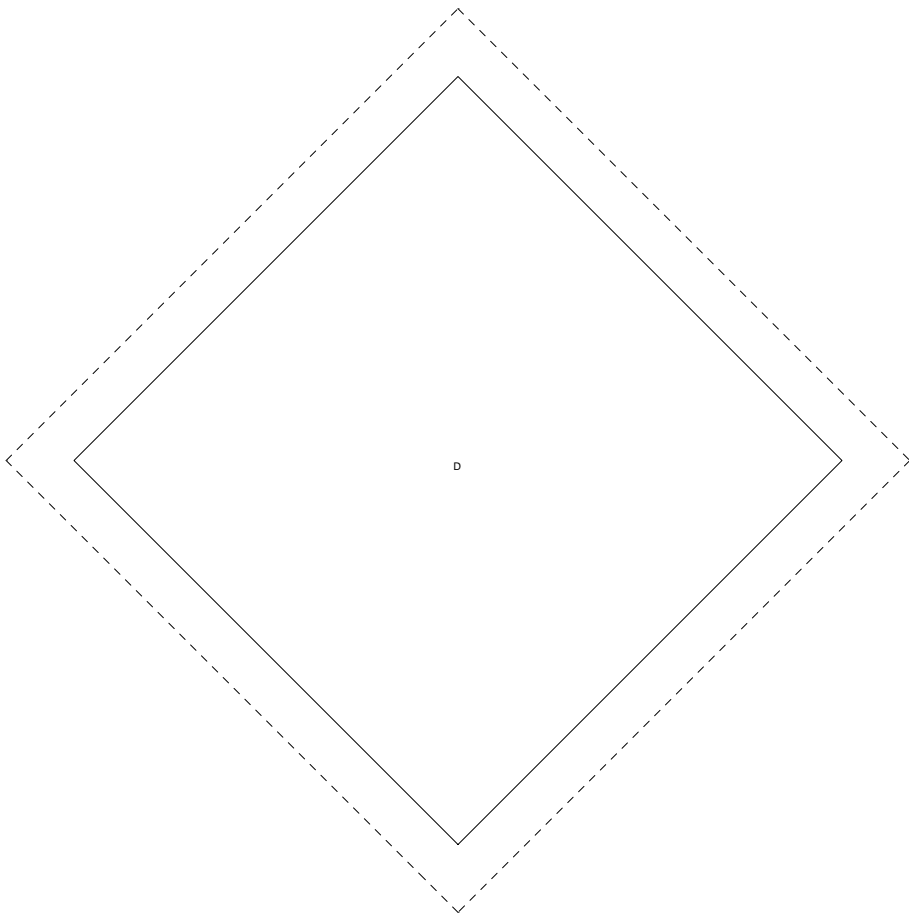
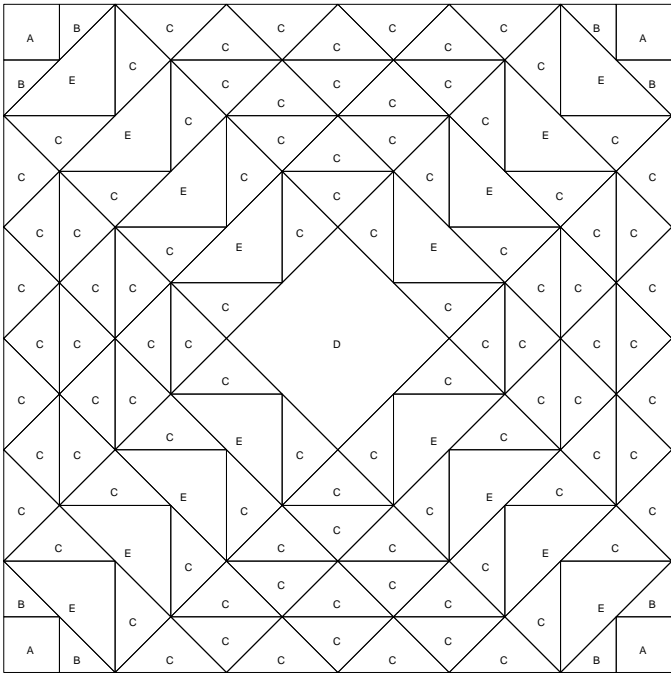

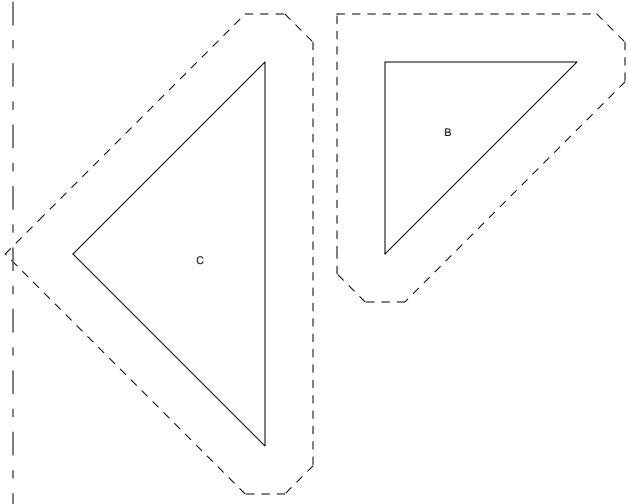

Far West

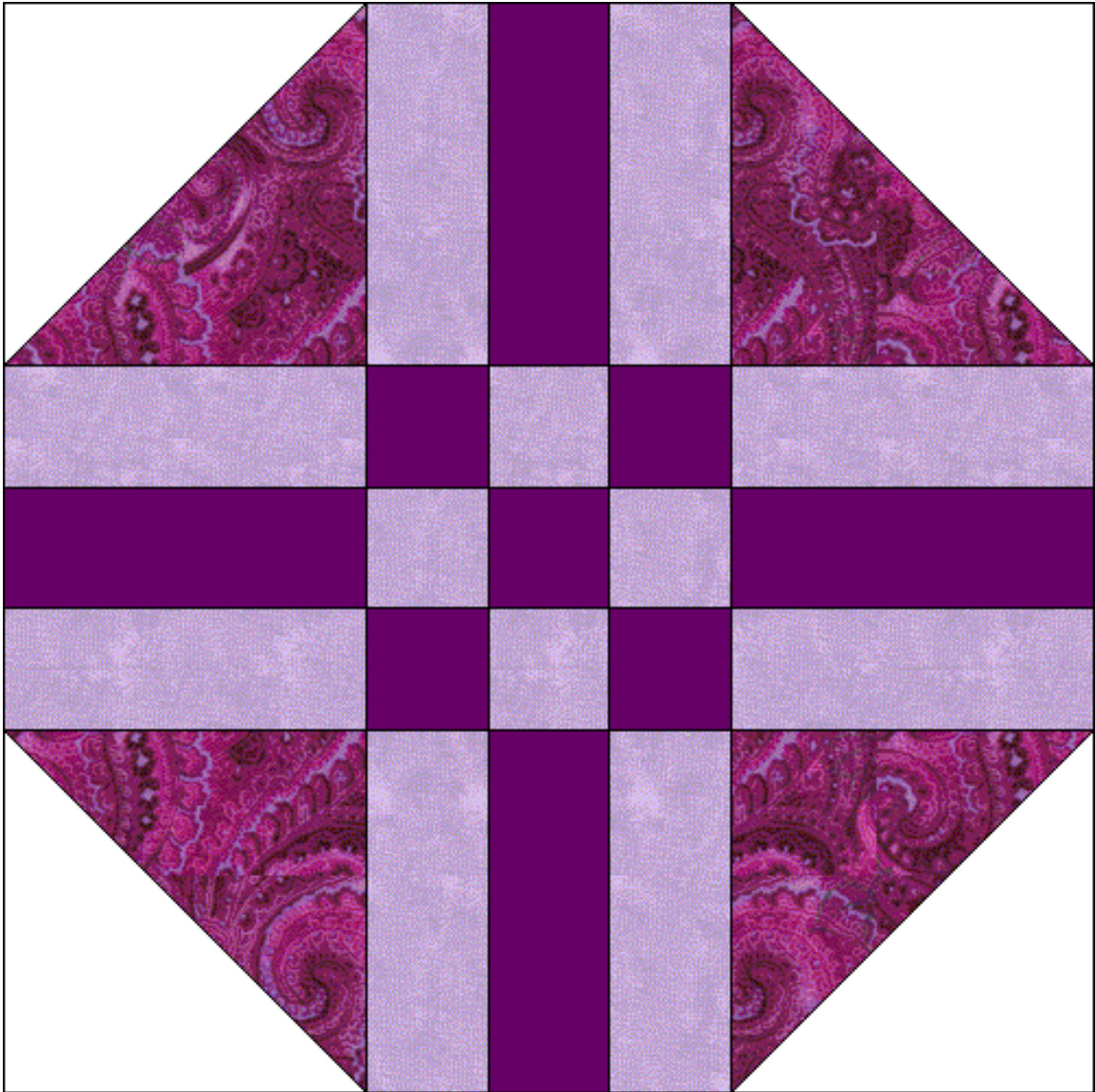

Far West
 Pattern for 12.00x12.00 block
 Key Block (1/5 actual size)

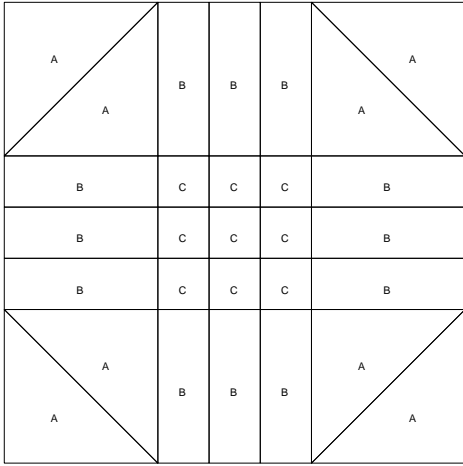

Cutting Diagrams

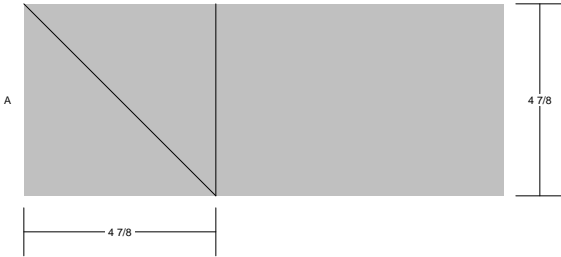

Patch Count

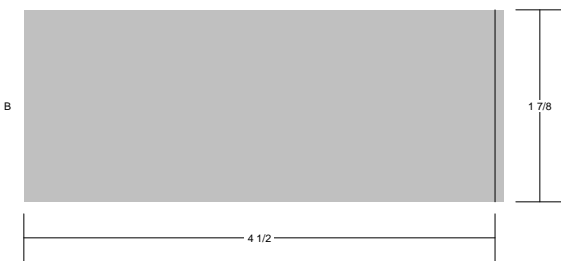

Far West
Pattern for 12.00x12.00 block
Key Block (29/100 actual size)

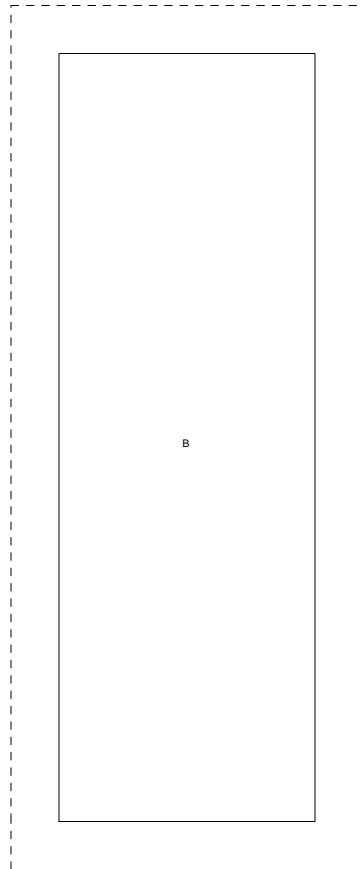
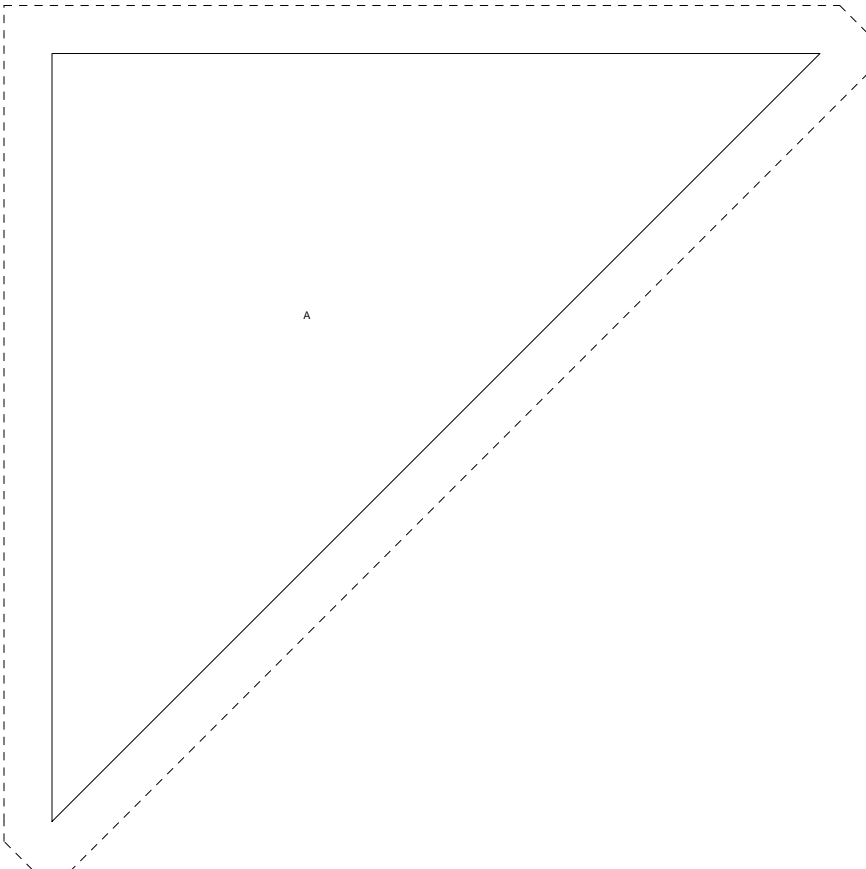
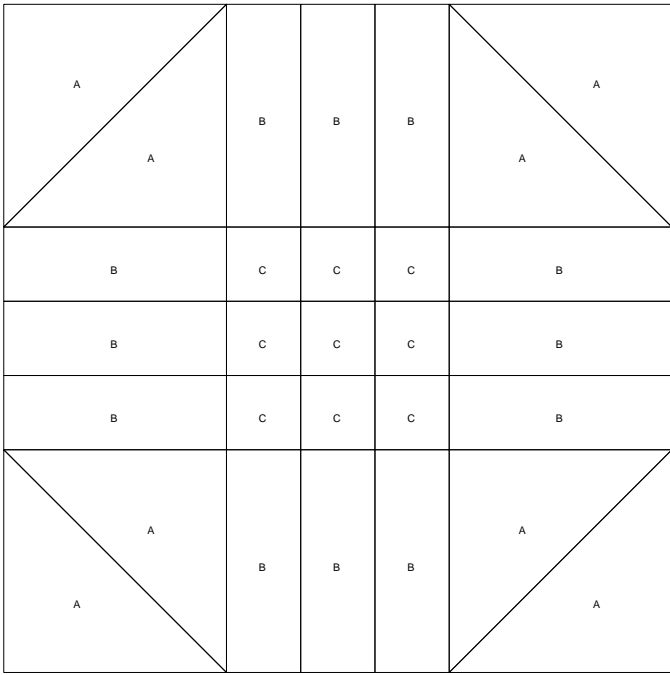

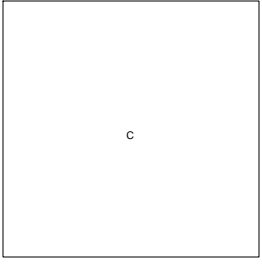

c

Hopes and Wishes

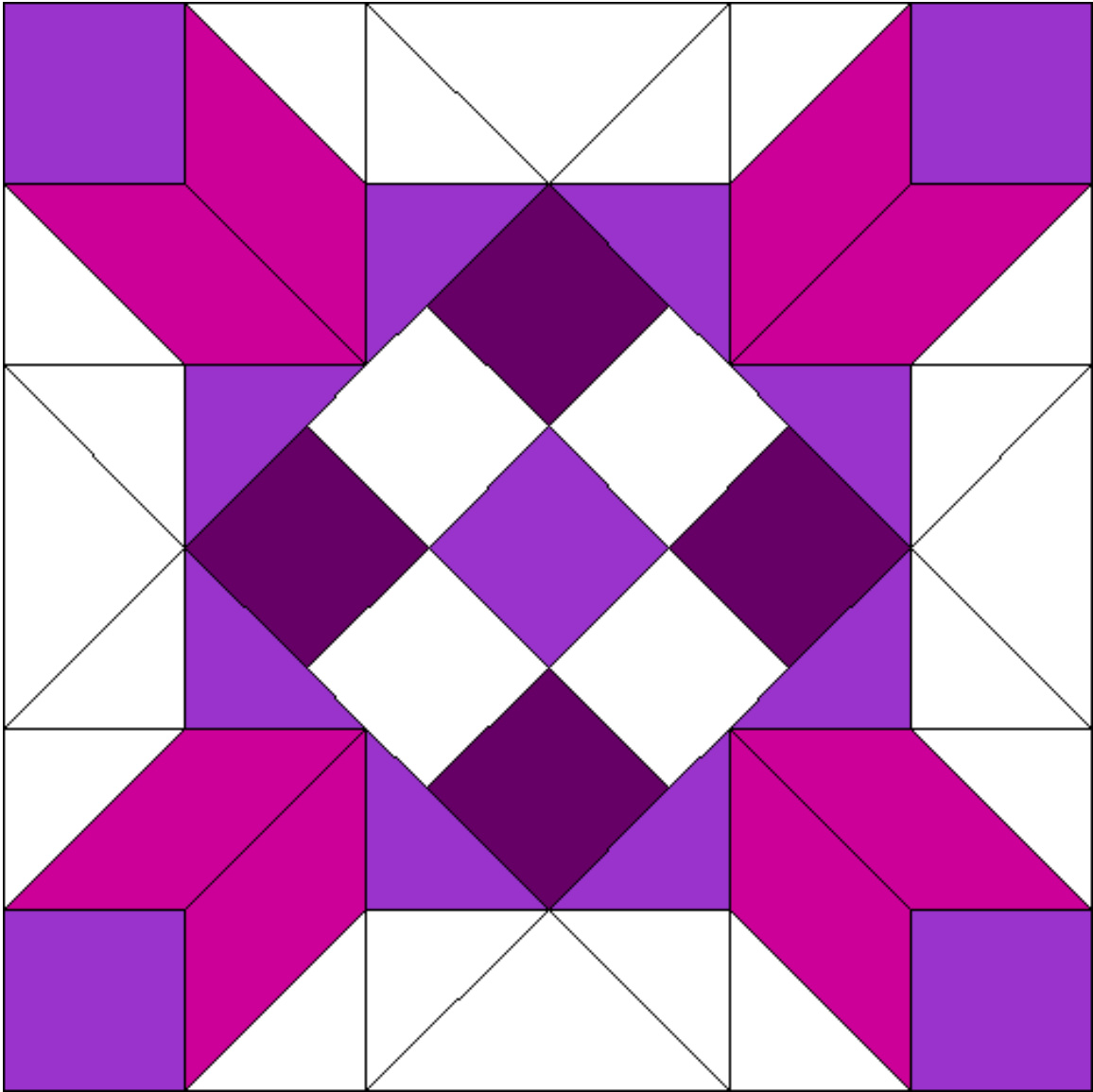

Hopes and Wishes
 Pattern for 12.00x12.00 block
 Key Block (1/5 actual size)

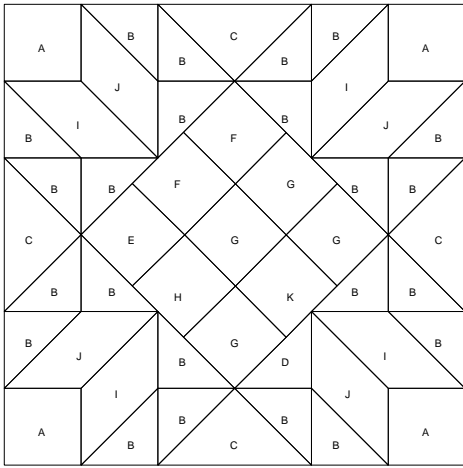

Cutting Diagrams



Patch Count

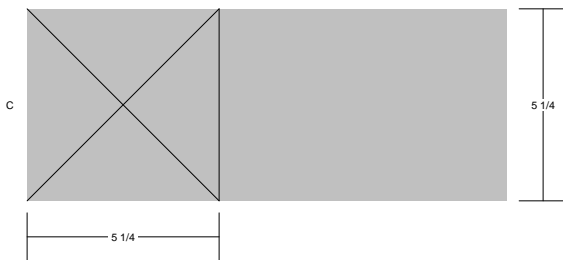
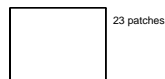
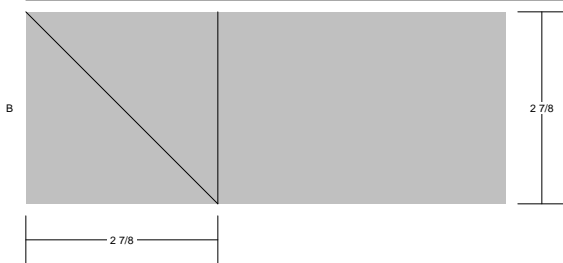

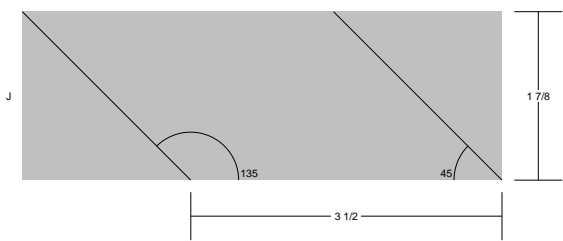
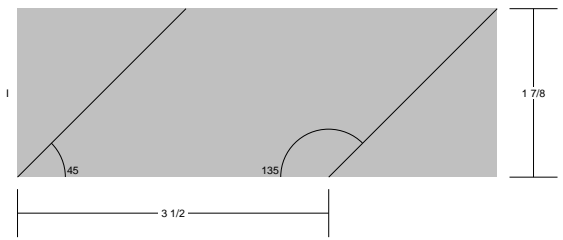
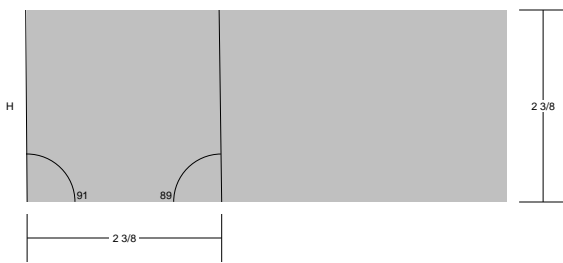
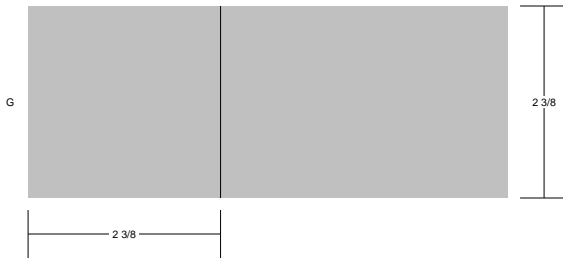
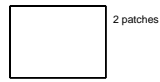
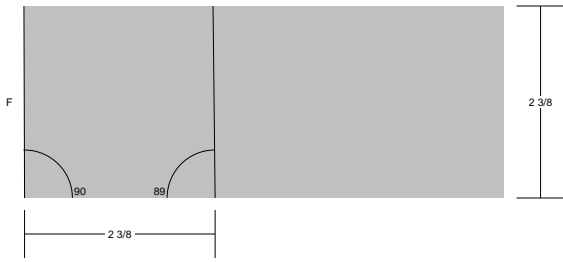

Hopes and Wishes
Pattern for 12.00x12.00 block
Key Block (29/100 actual size)

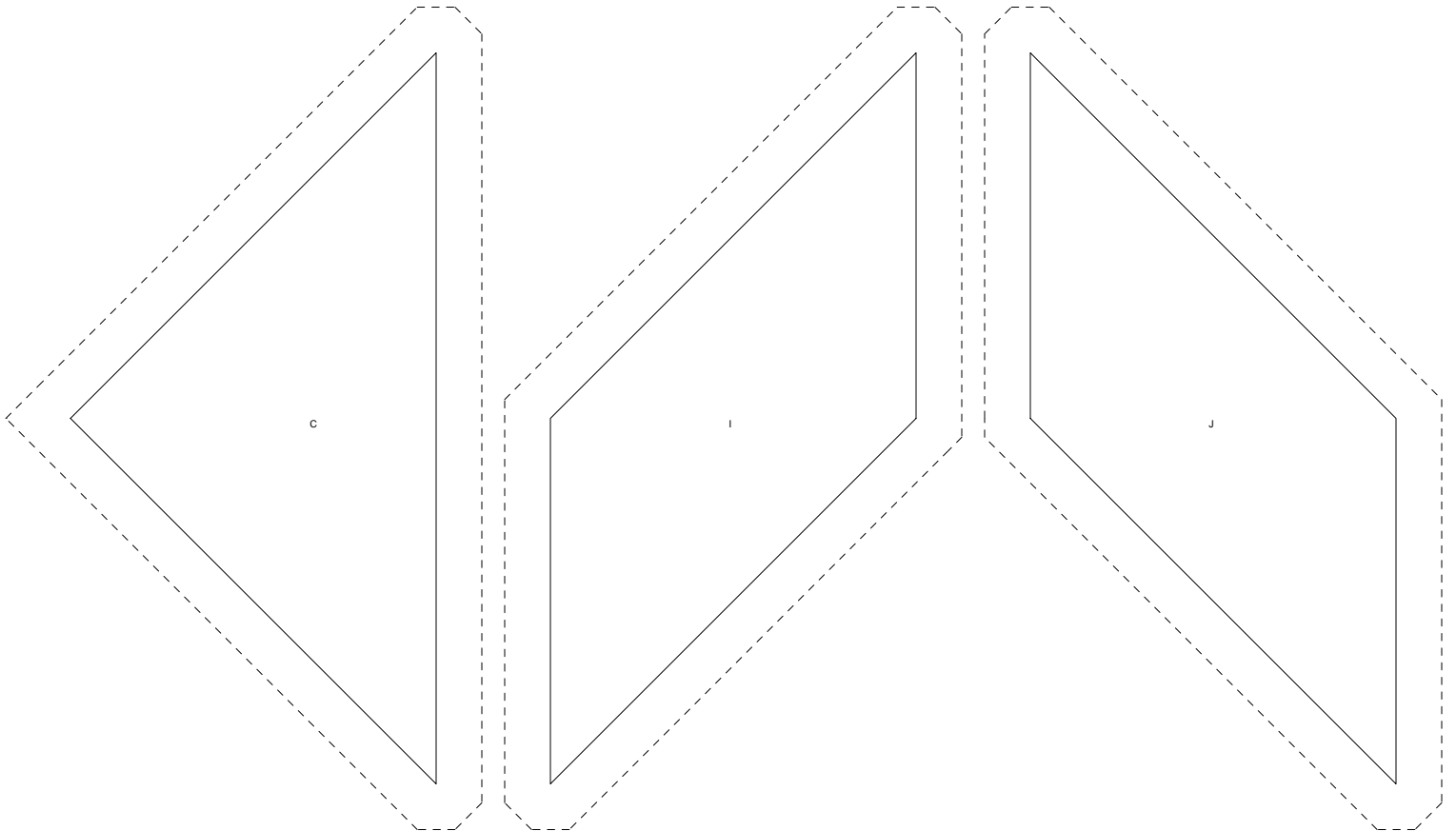
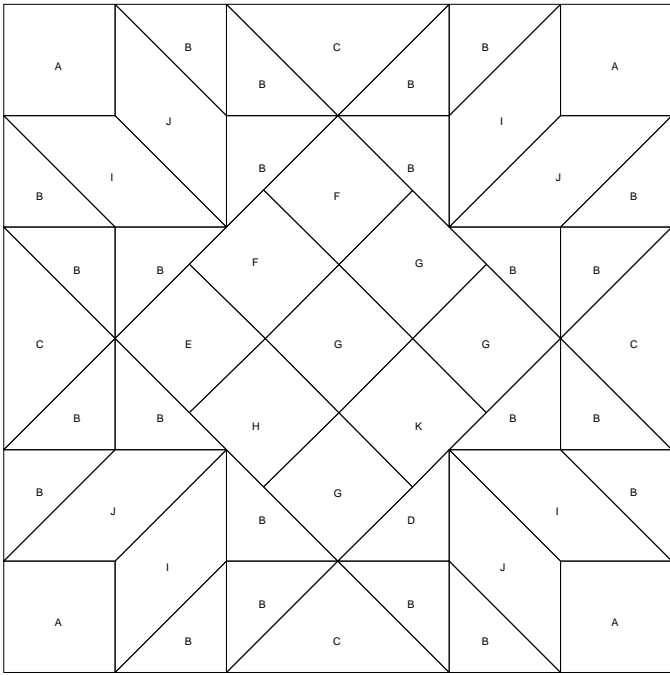

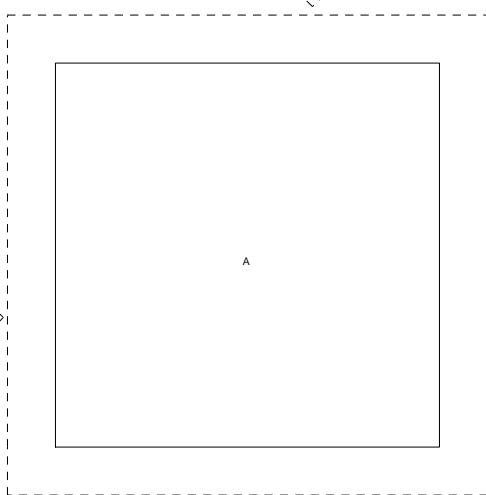
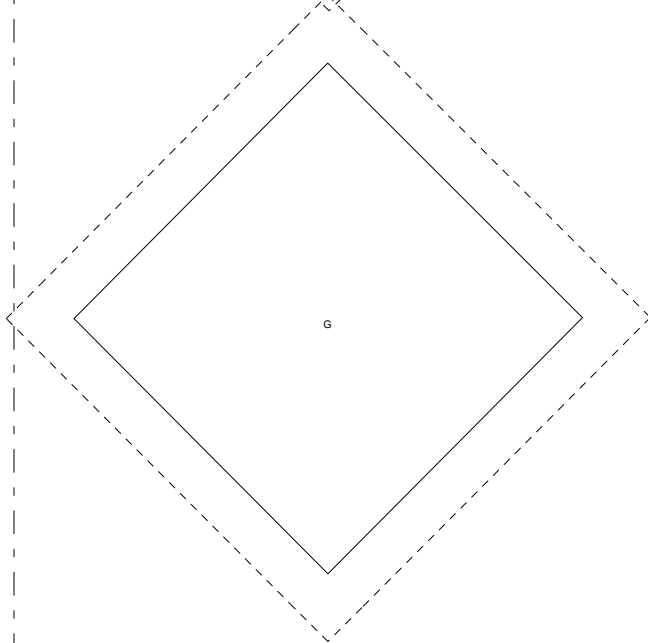
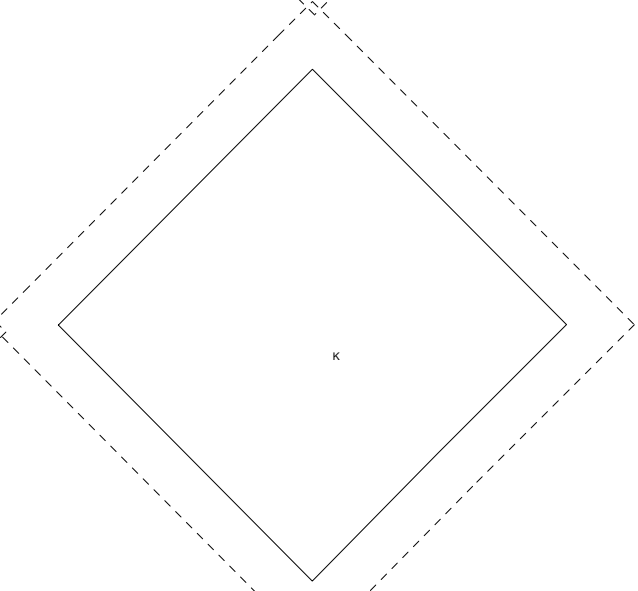
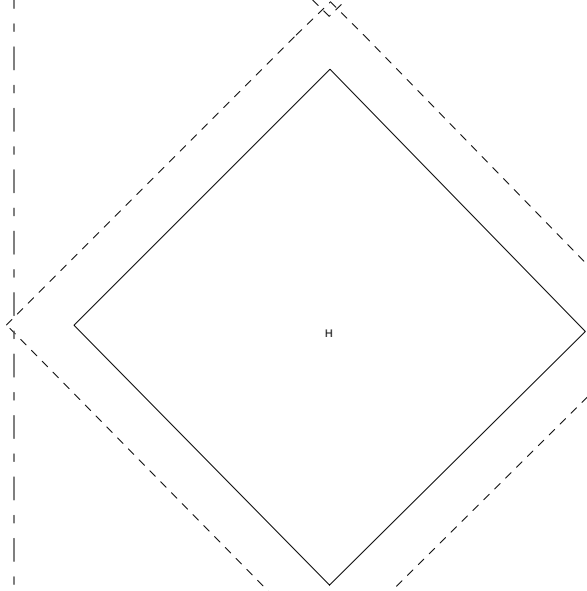
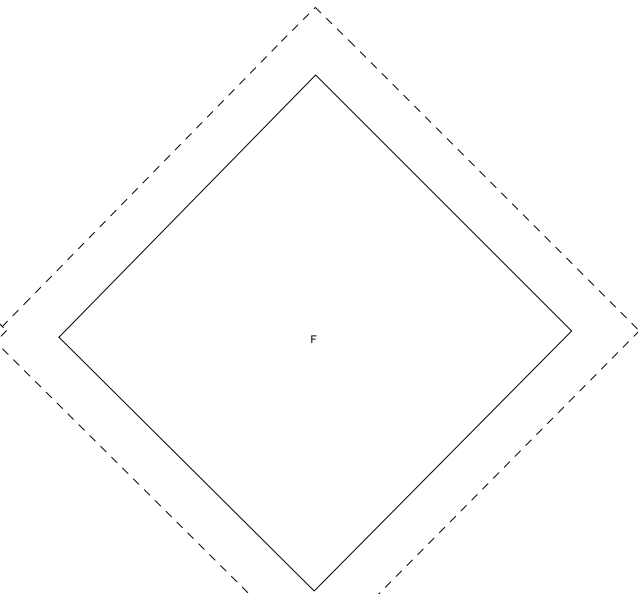
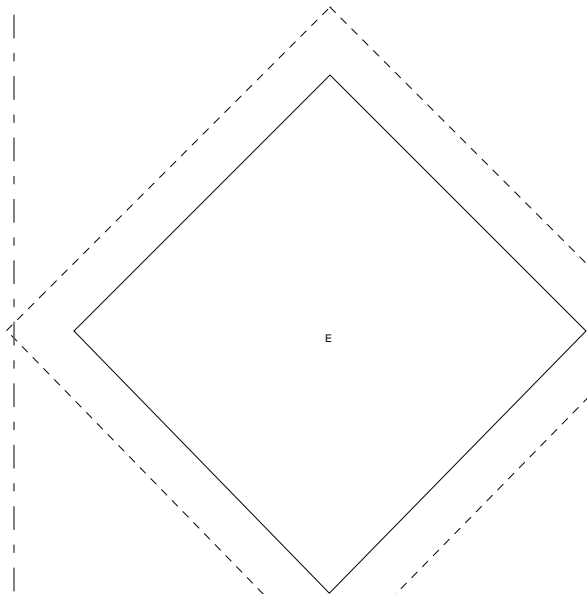

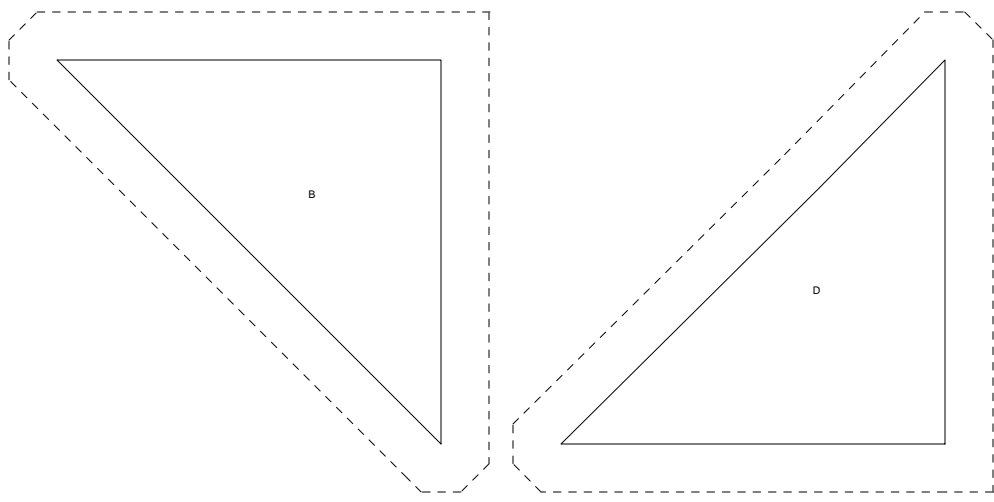

Ladies' Delight

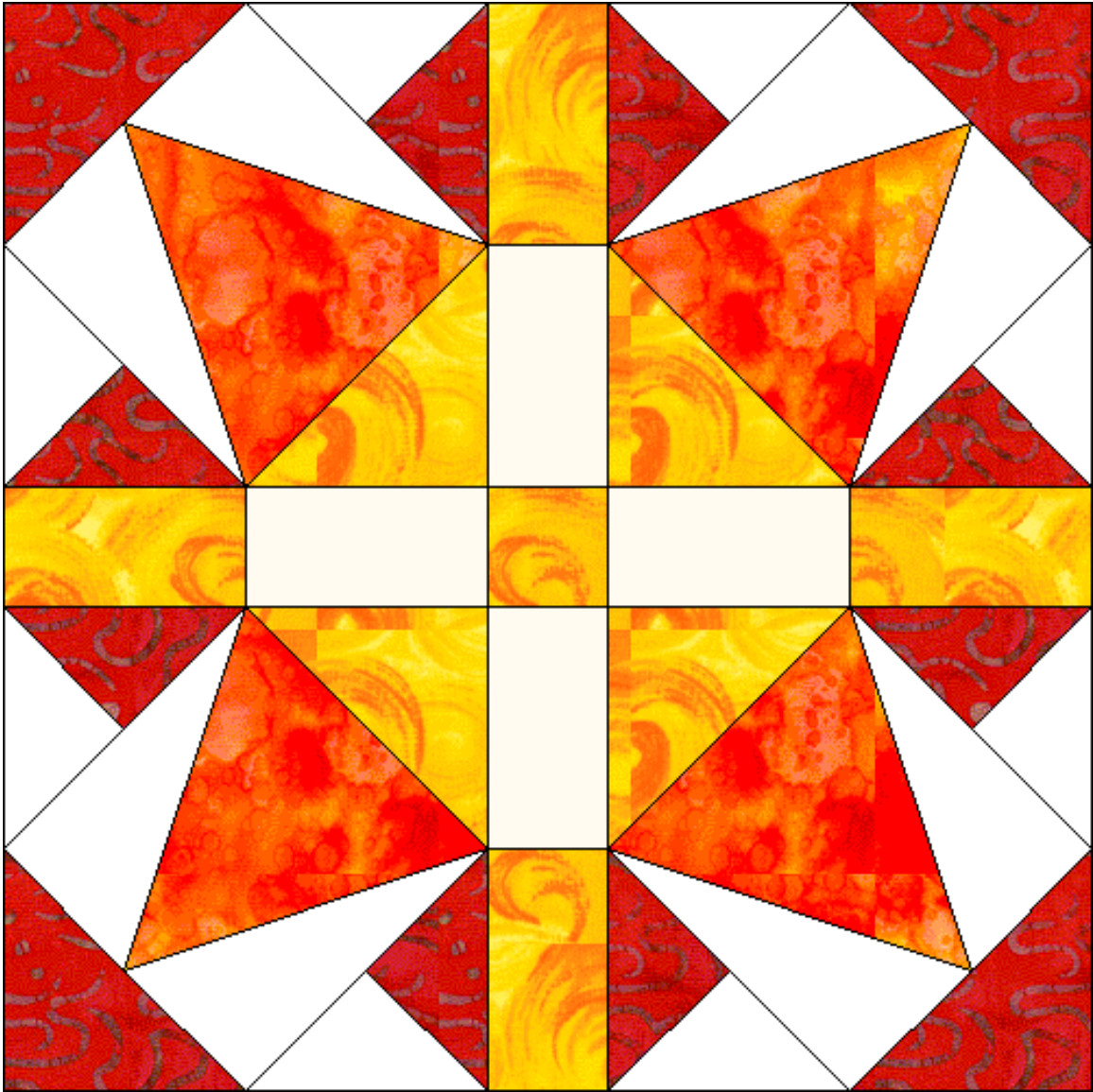

Ladies' Delight
 Pattern for 9.00x9.00 block
 Key Block (27/100 actual size)

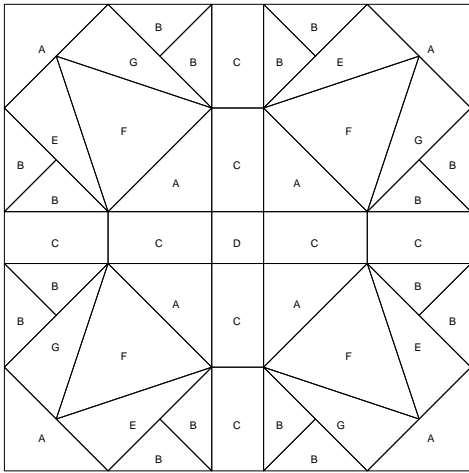

Cutting Diagrams

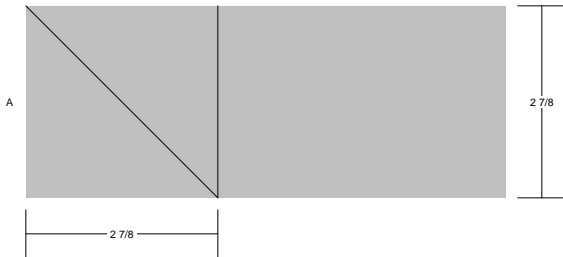

Patch Count

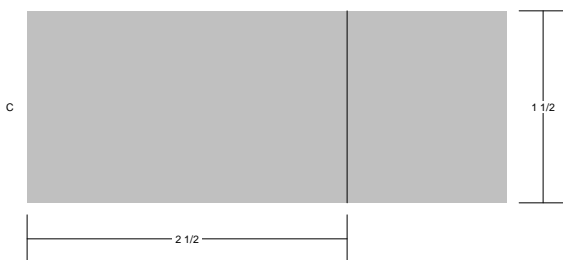
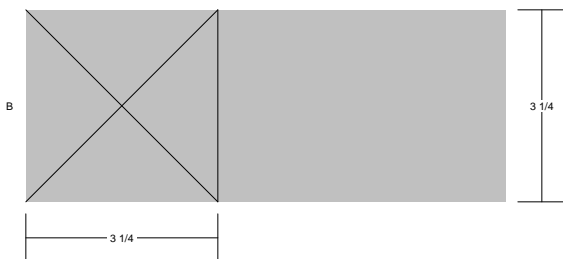

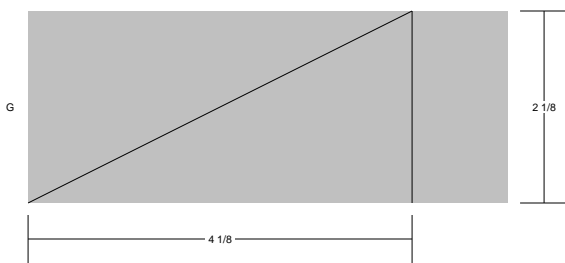
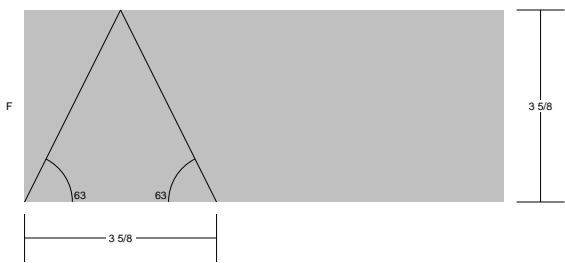
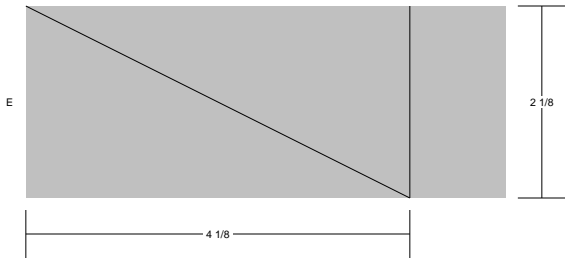

Ladies' Delight
Pattern for 9.00x9.00 block
Key Block (19/50 actual size)

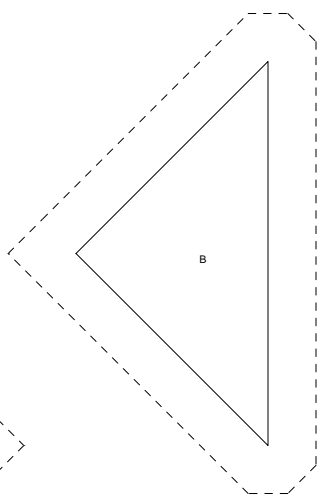
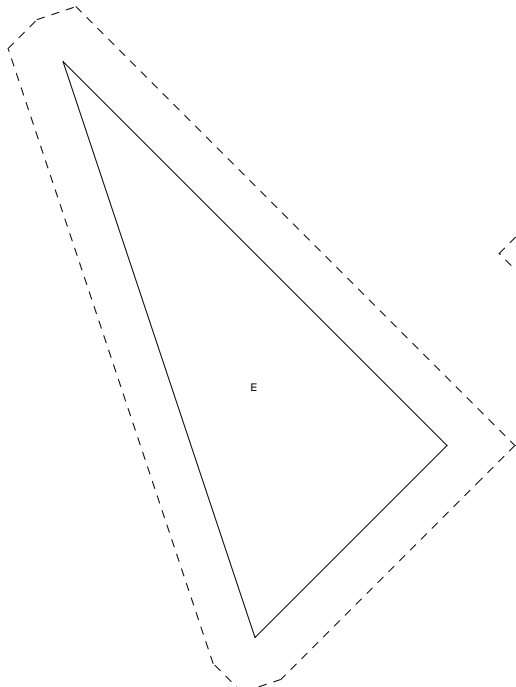
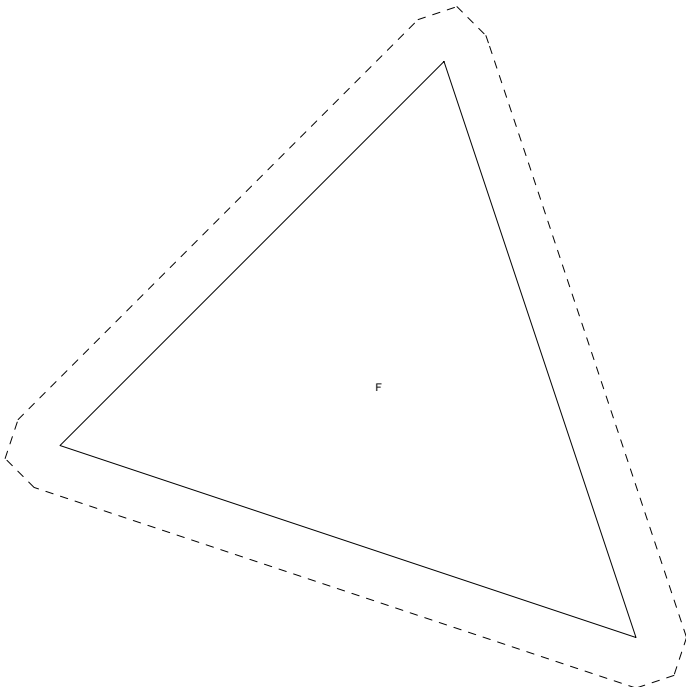
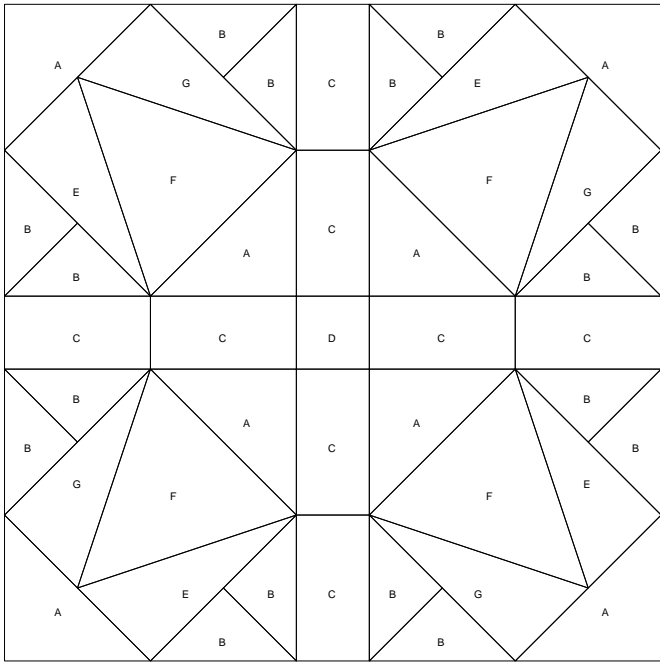

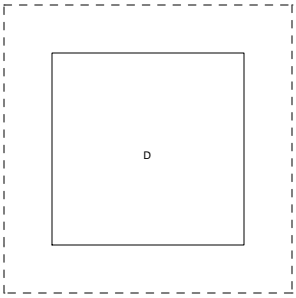
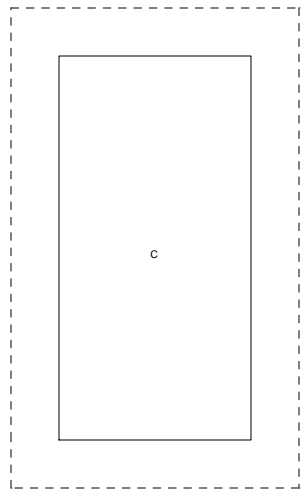
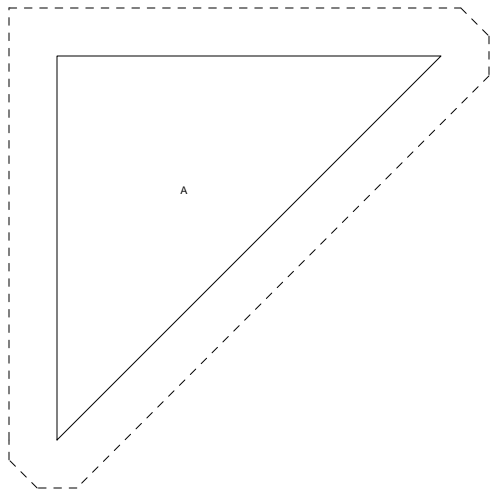
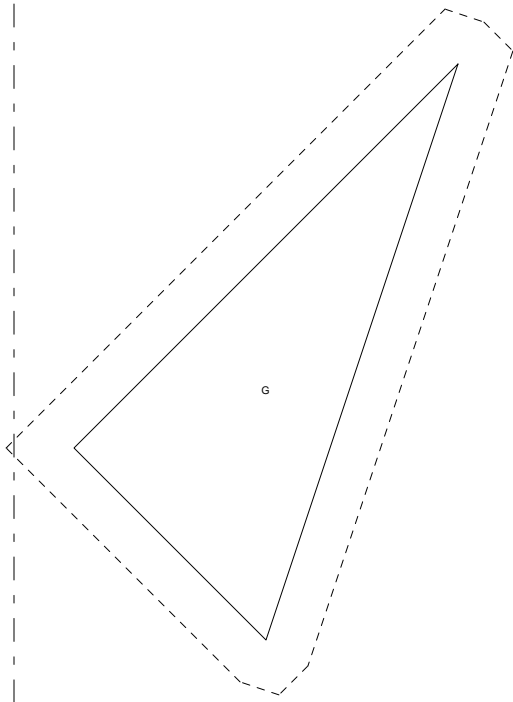

Lady of the White House

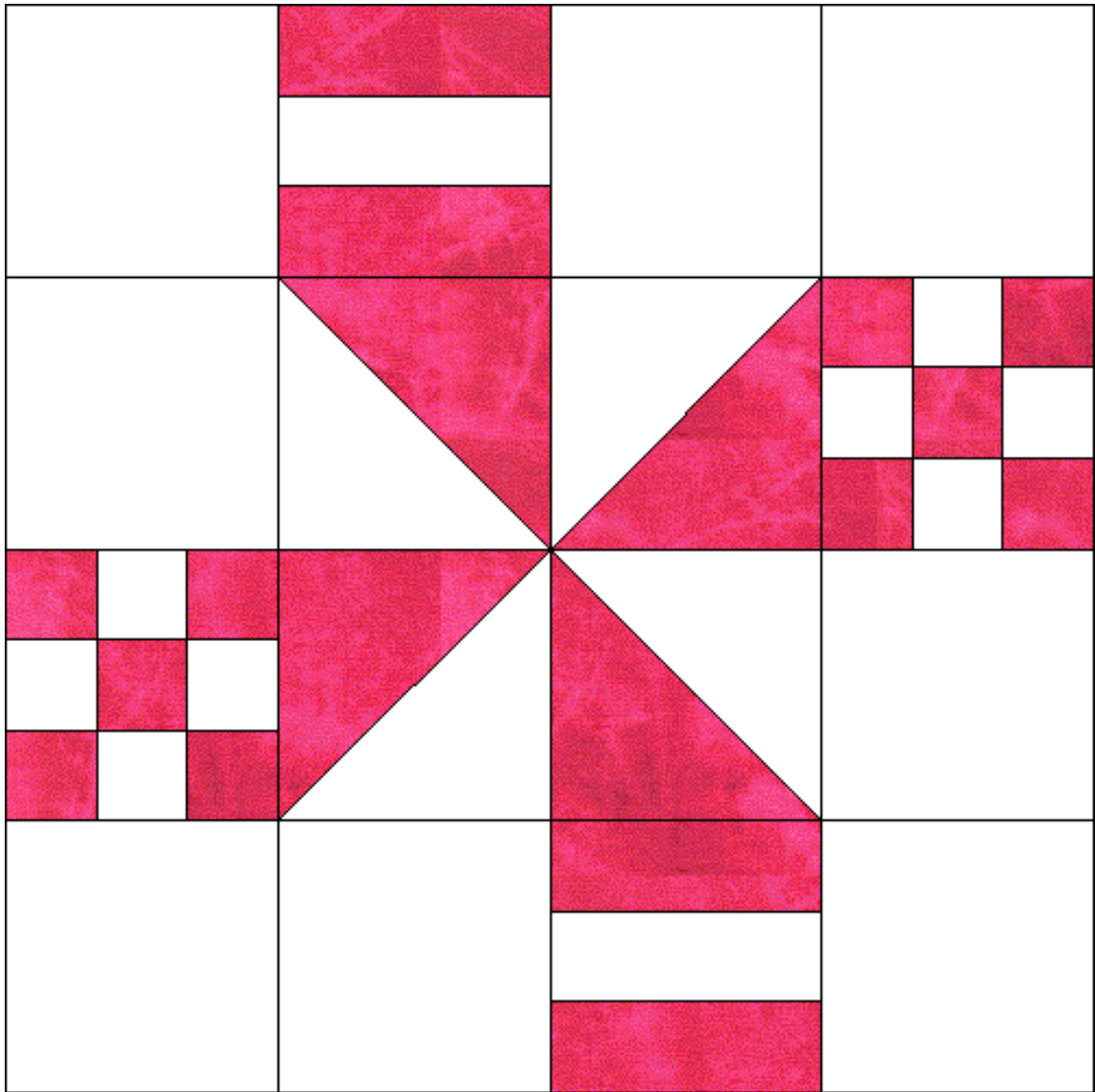

Lady of the White House
 Pattern for 12.00x12.00 block
 Key Block (1/5 actual size)

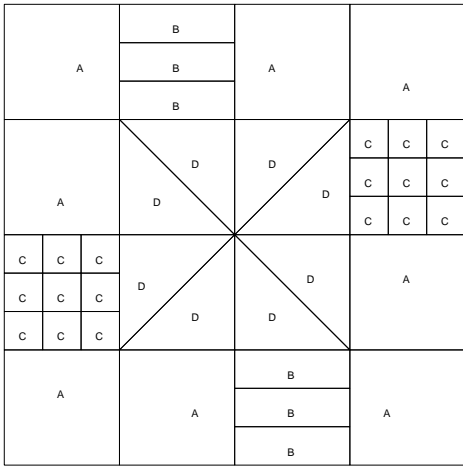

Cutting Diagrams



Patch Count

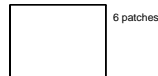
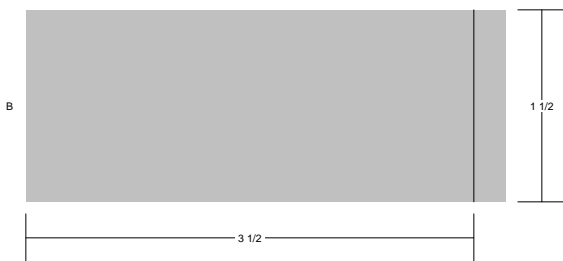

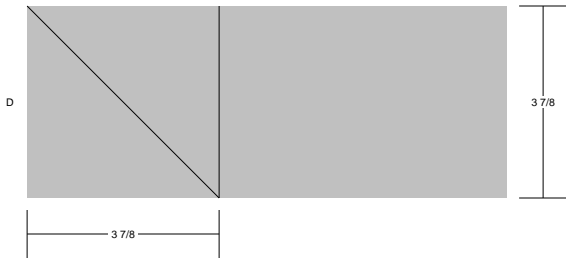

8 patches



Lady of the White House
 Pattern for 12.00x12.00 block
 Key Block (29/100 actual size)

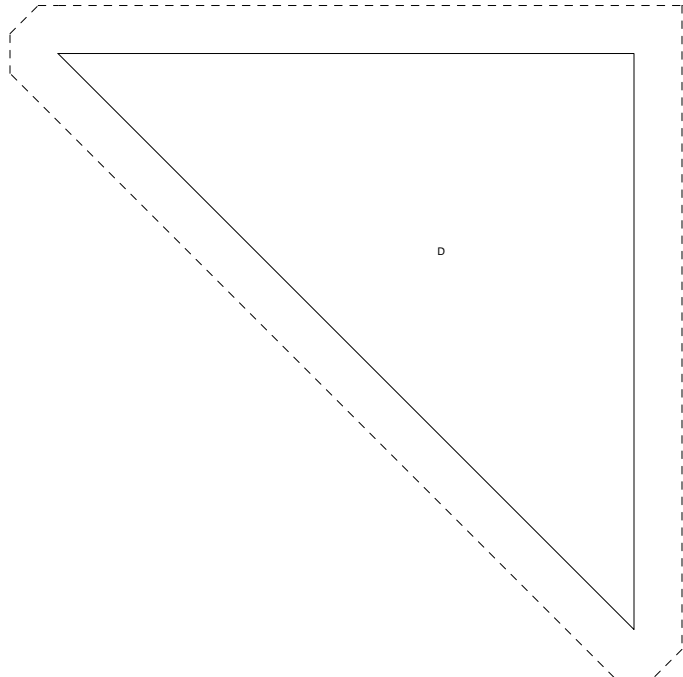
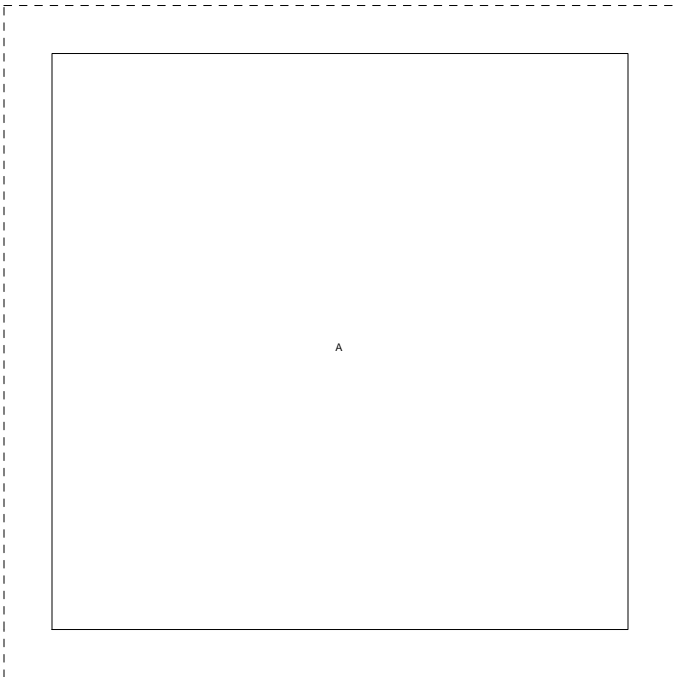
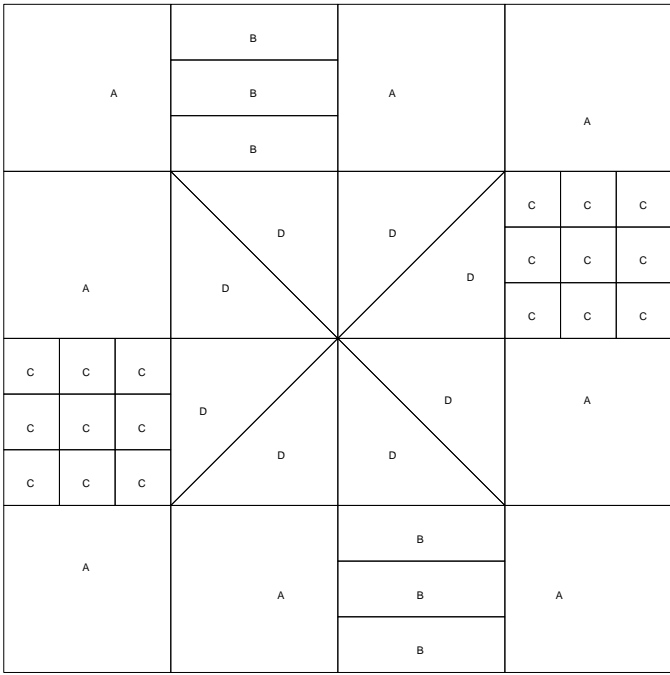

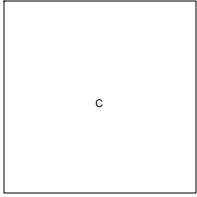
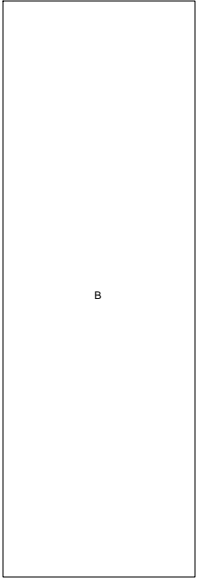

Missouri Puzzle

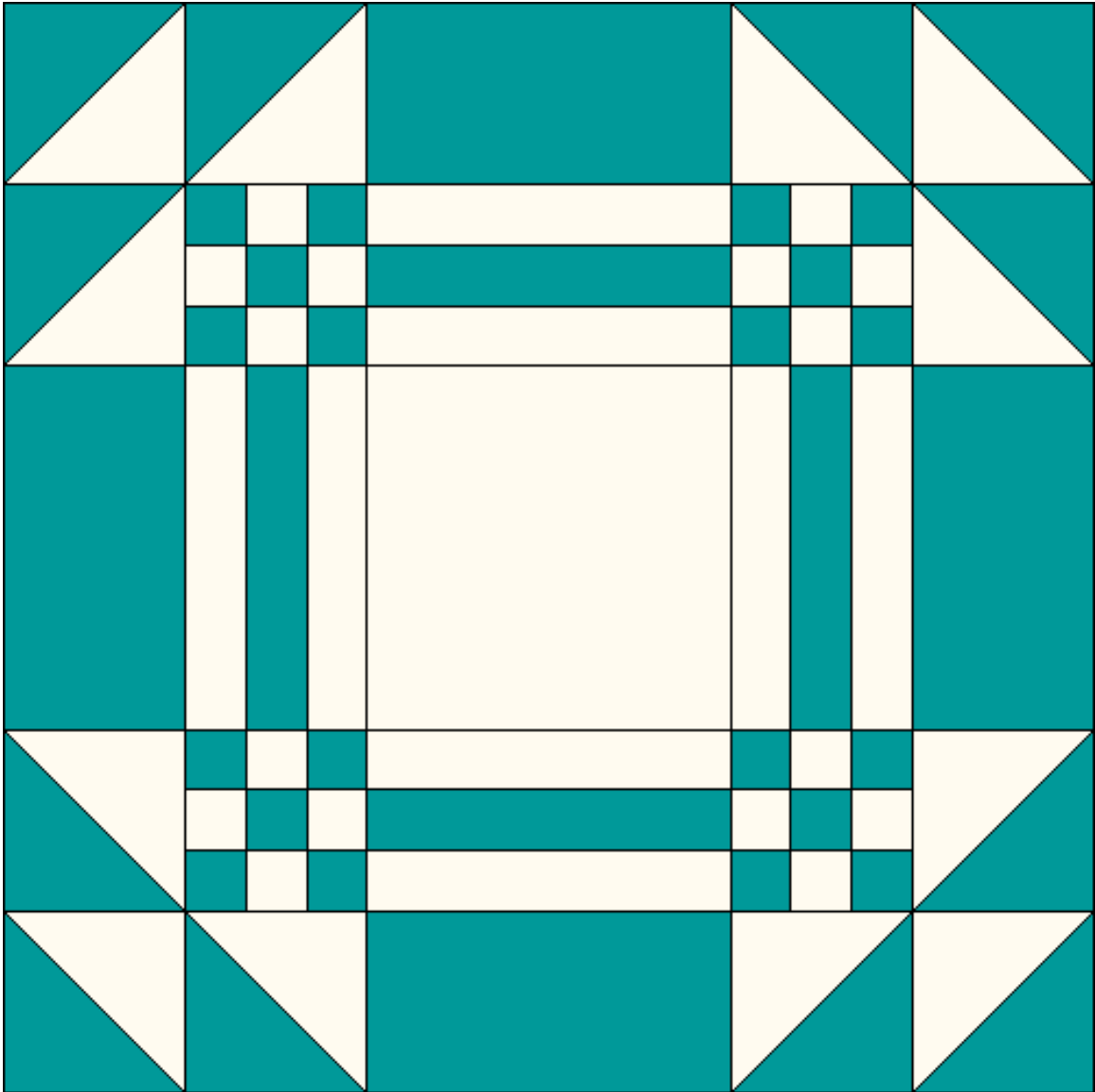

Missouri Puzzle
 Pattern for 6.00x6.00 block
 Key Block (41/100 actual size)

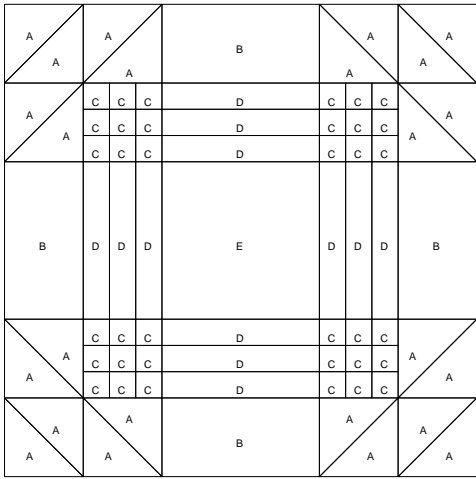

Cutting Diagrams

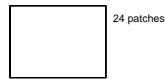
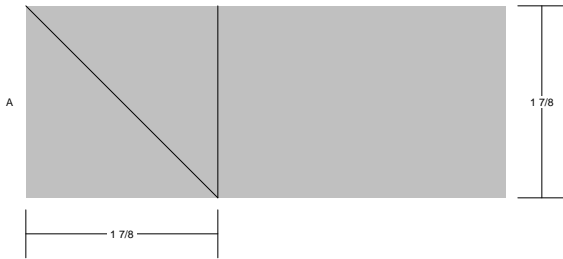

Patch Count

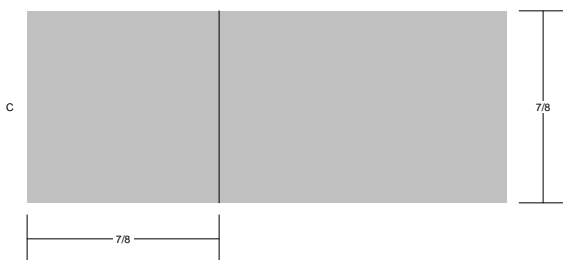
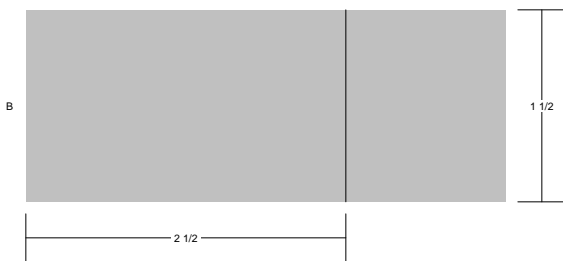

D

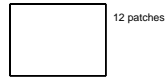
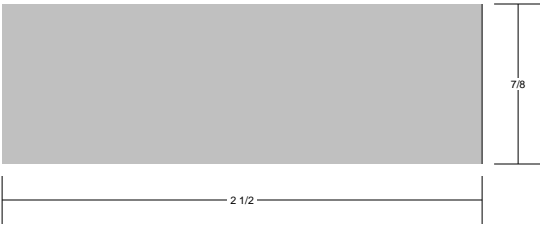

E



Missouri Puzzle
 Pattern for 6.00x6.00 block
 Key Block (29/50 actual size)

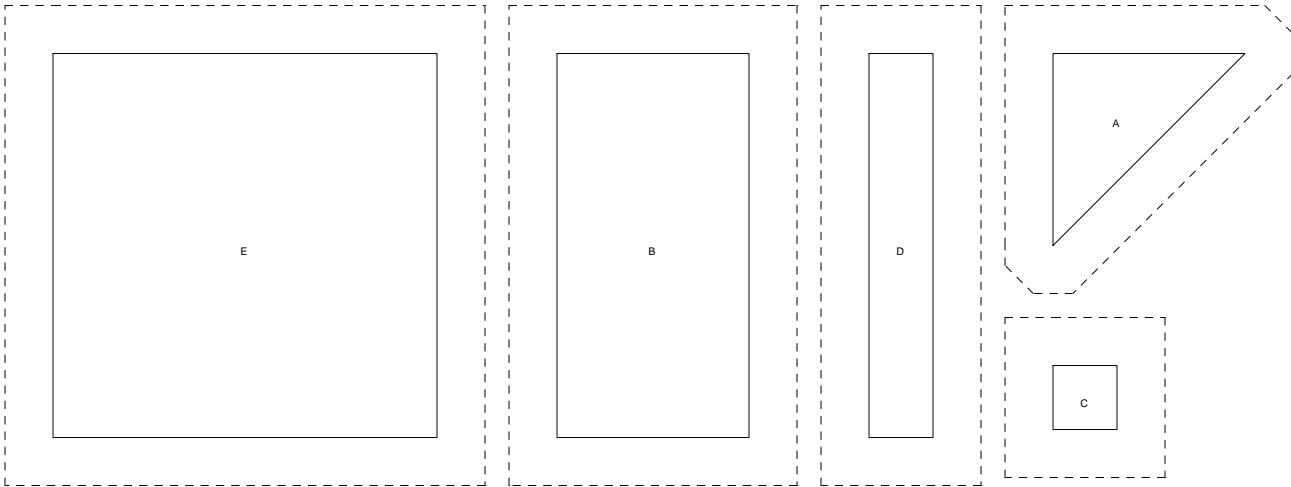
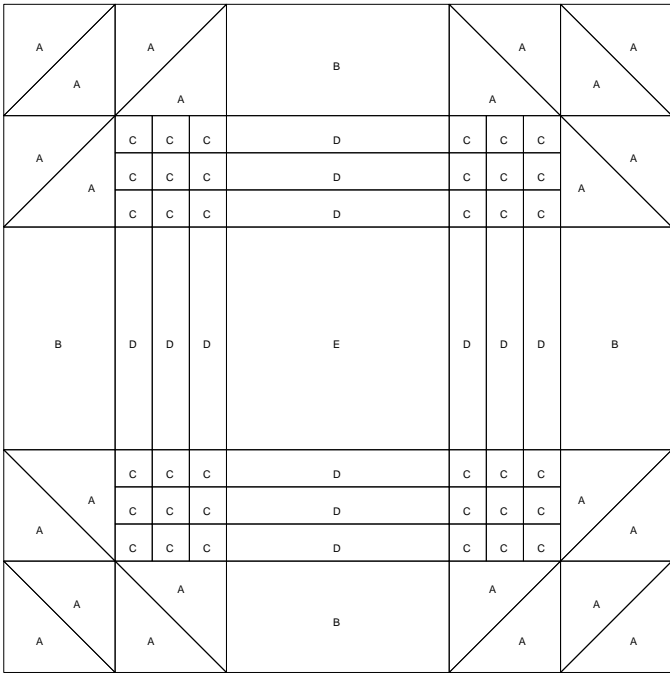

Ribbon Bow

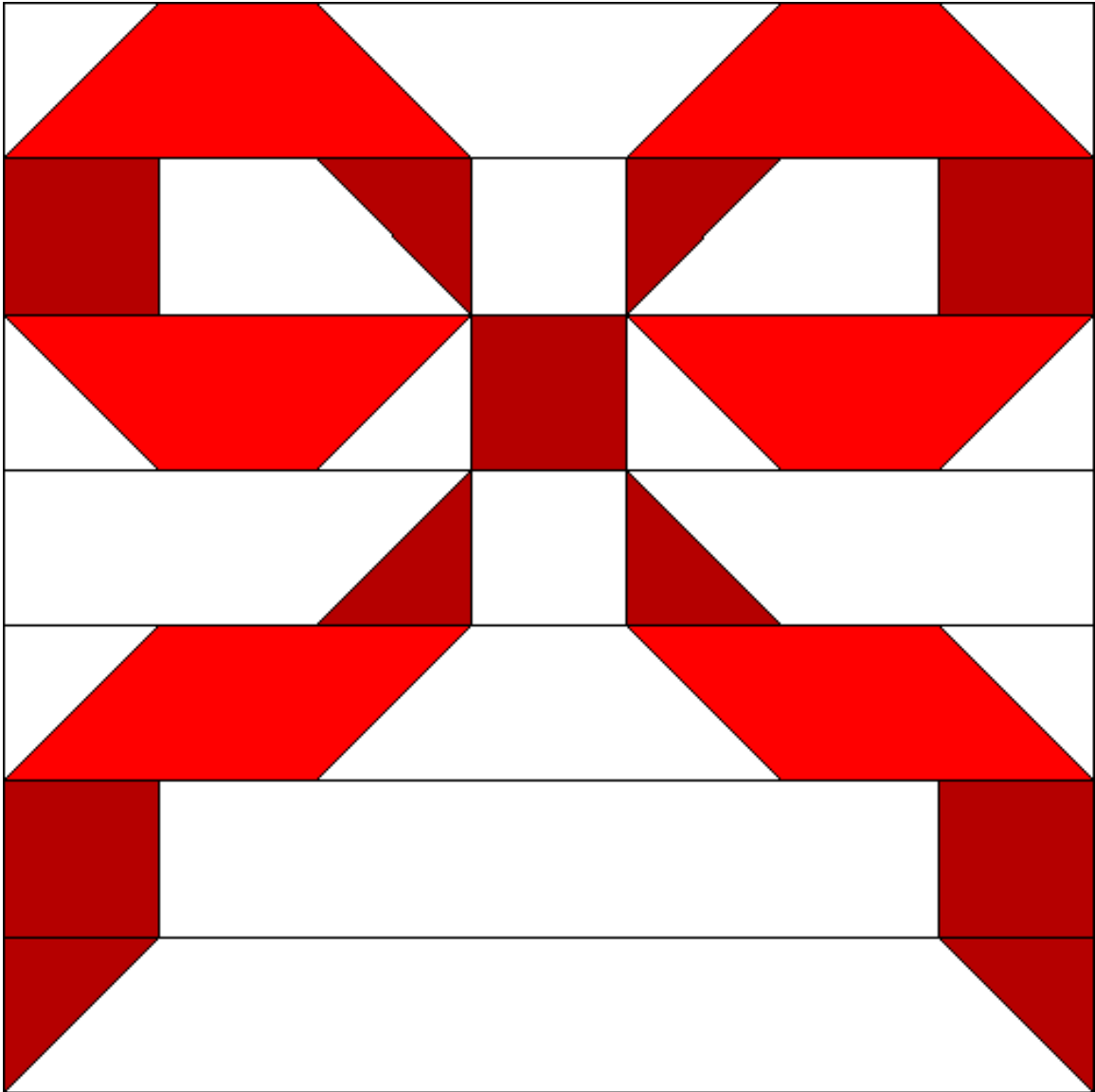

Ribbon Bow
 Pattern for 7.00x7.00 block
 Key Block (7/20 actual size)

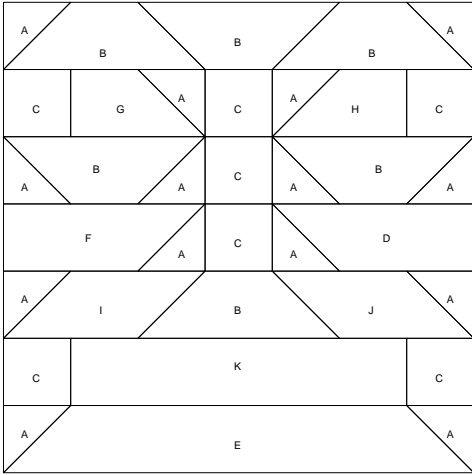

Cutting Diagrams

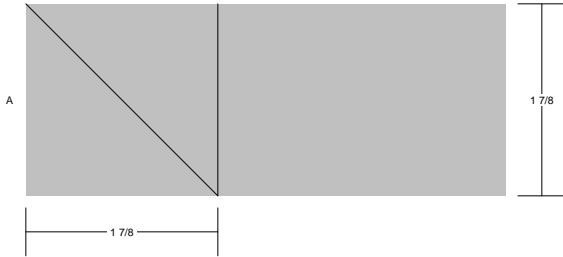

Patch Count

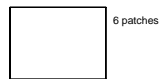
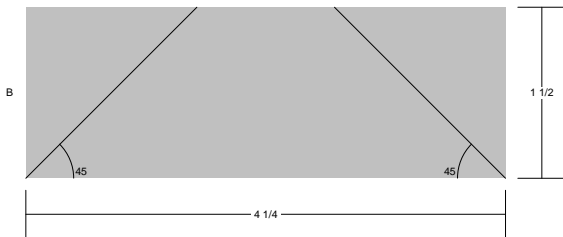

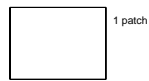
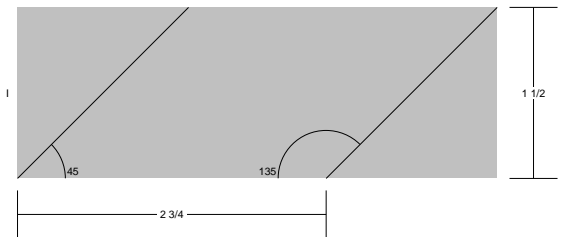
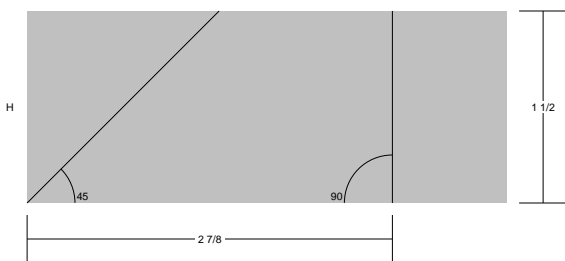
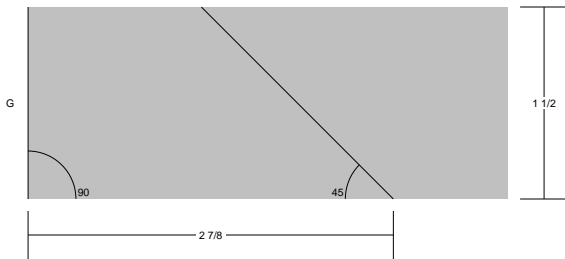
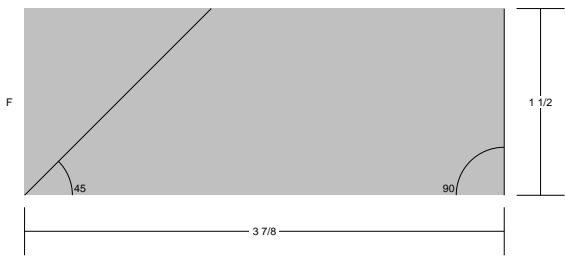
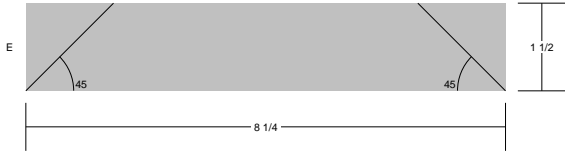
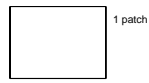
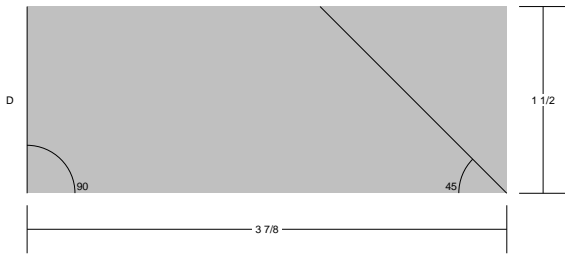

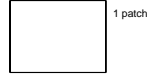
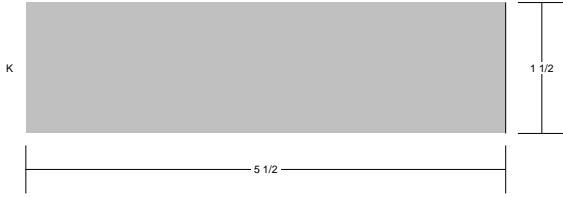
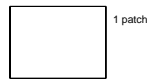
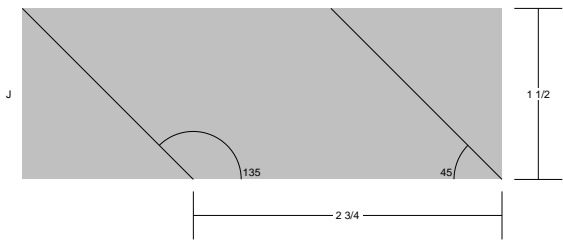

Ribbon Bow
Pattern for 7.00x7.00 block
Key Block (49/100 actual size)

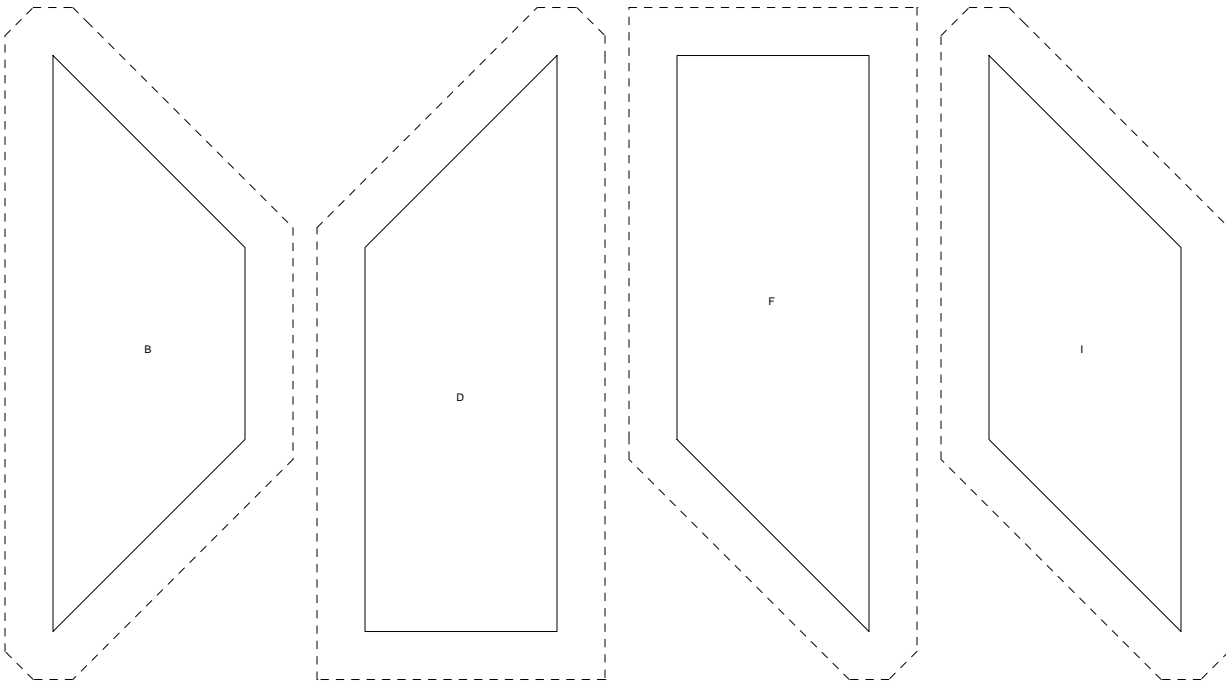
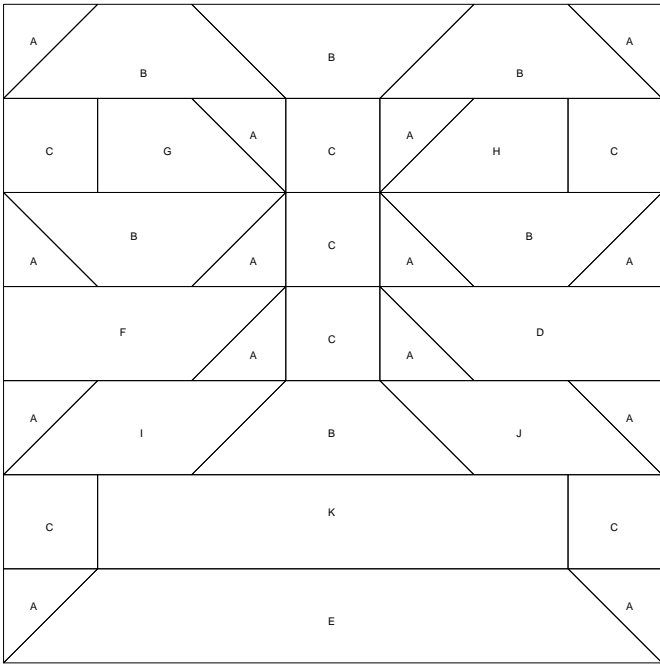

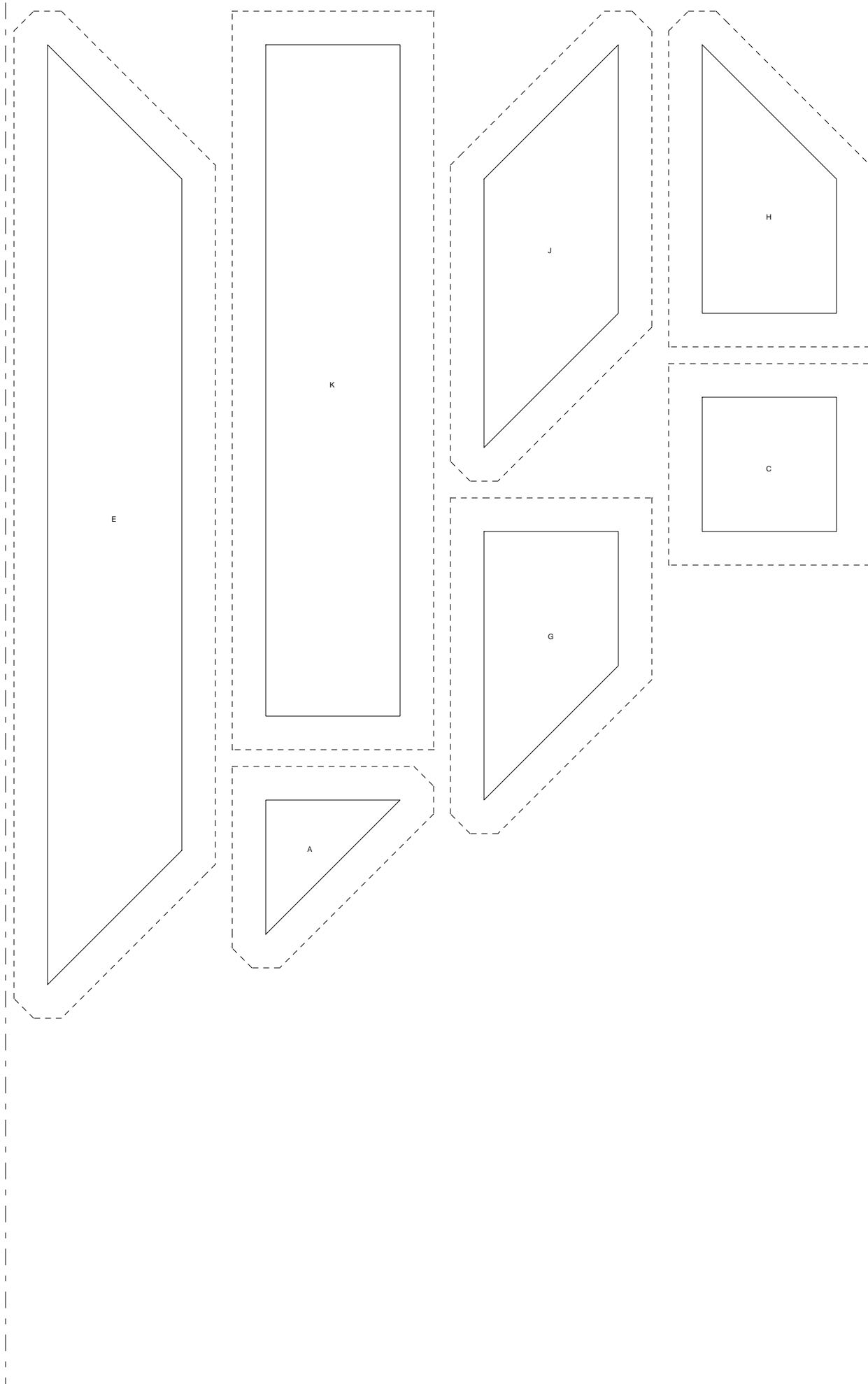

Teapot

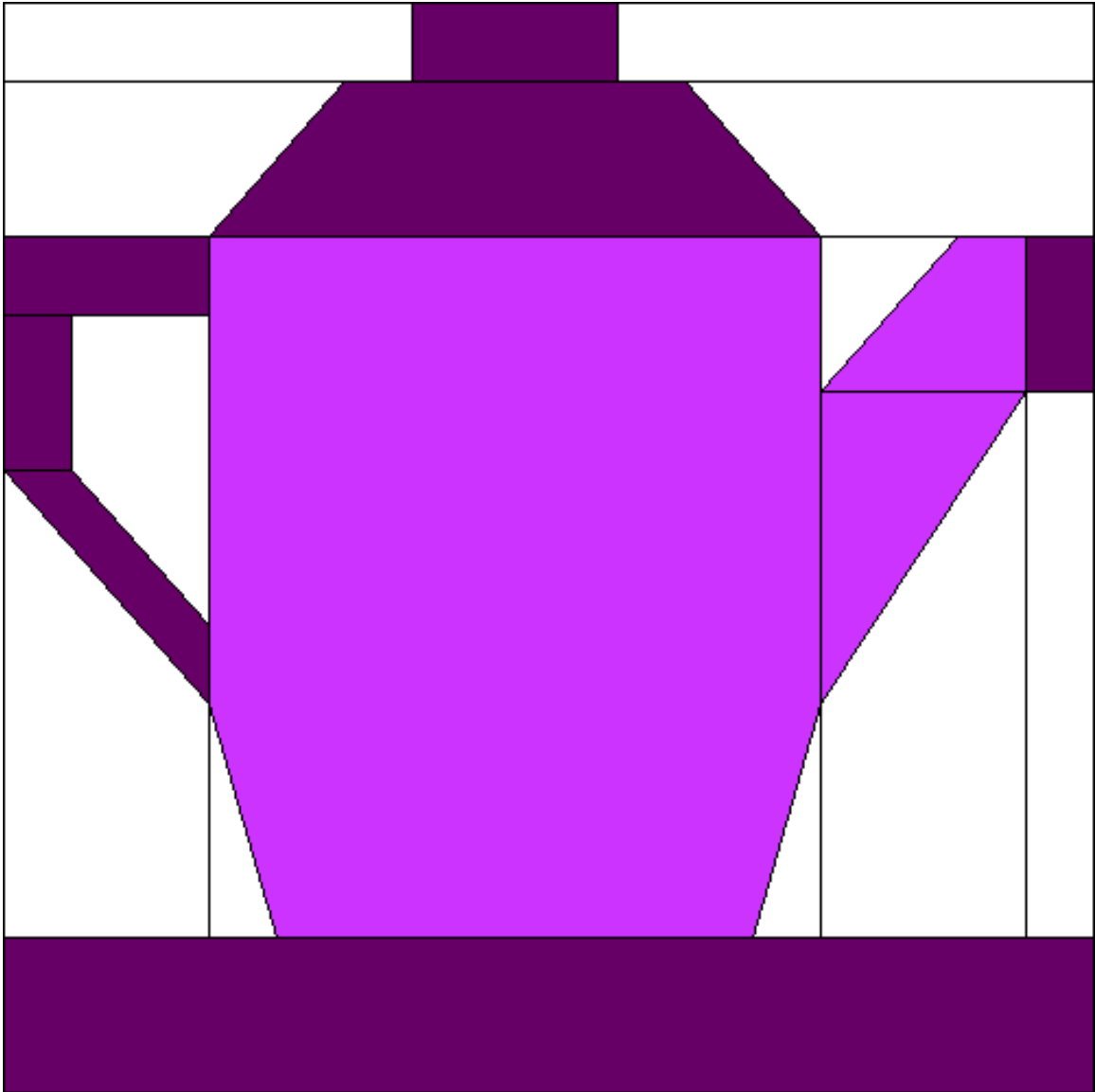

Teapot
 Pattern for 8.00x7.00 block
 Key Block (31/100 actual size)

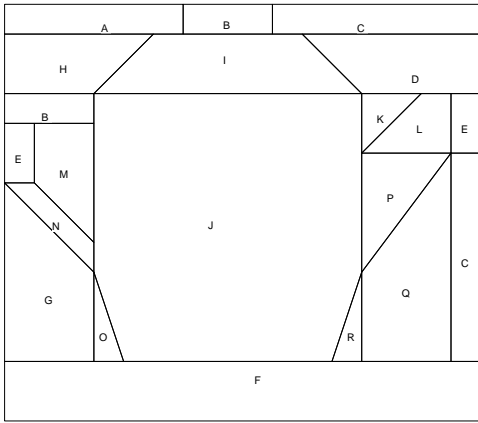

Cutting Diagrams

Patch Count

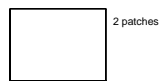
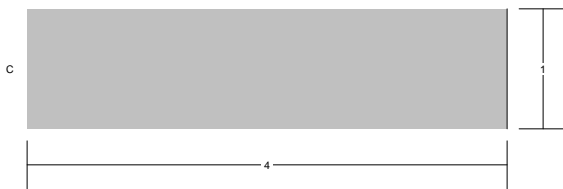
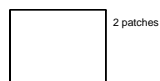
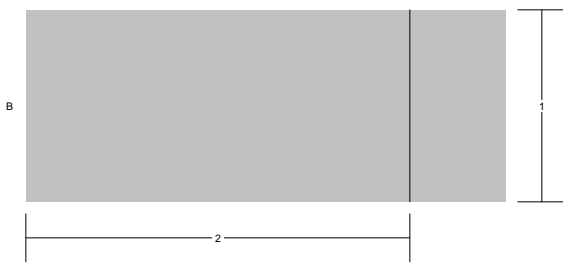
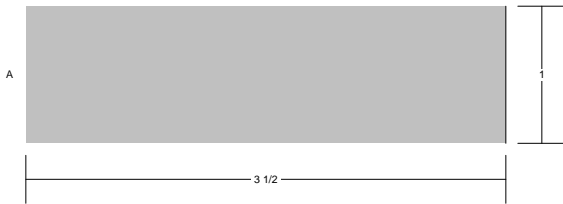

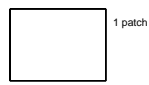
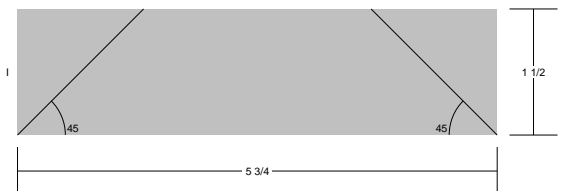
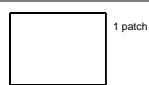
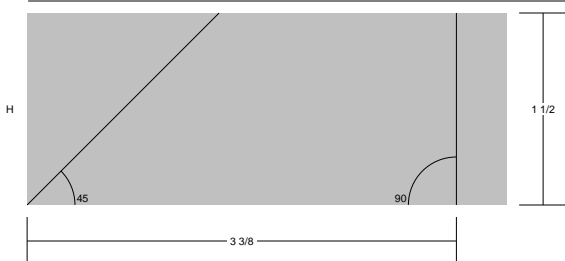
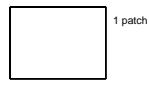
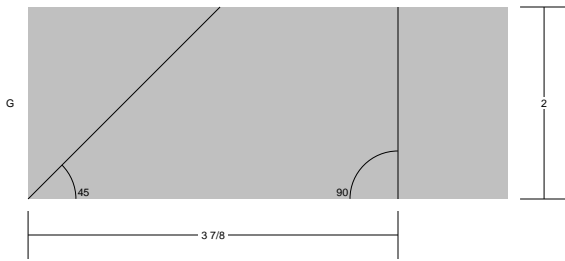
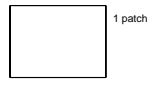
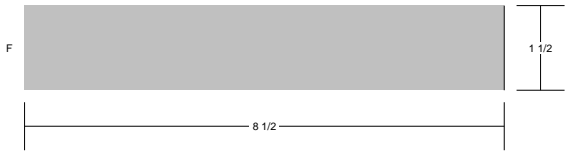
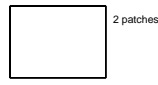
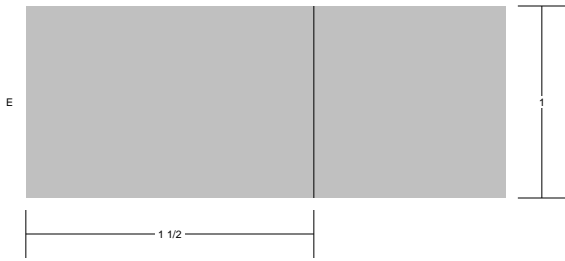
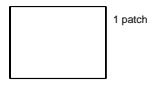
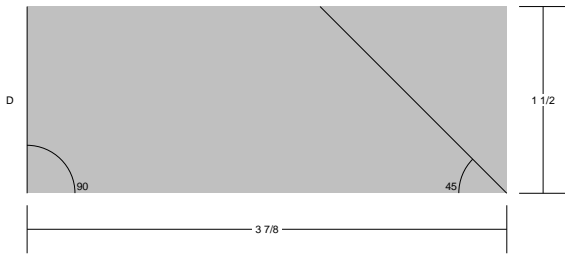

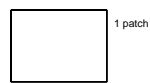
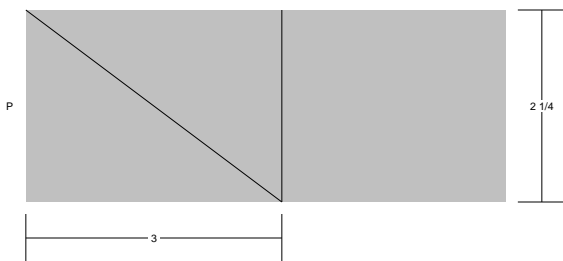
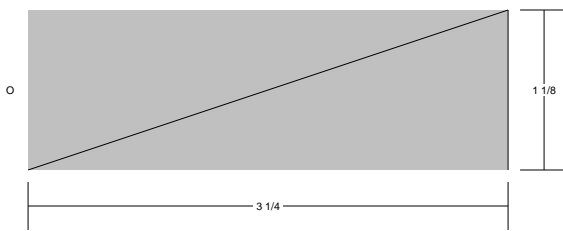
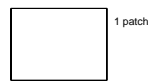
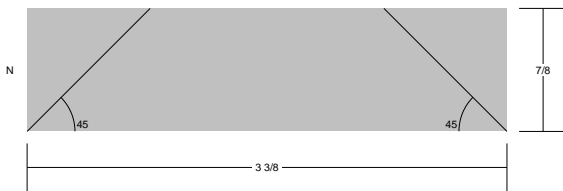
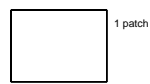
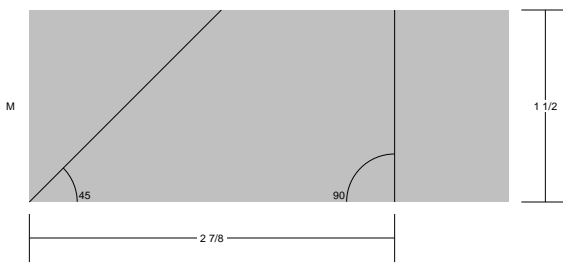
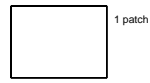
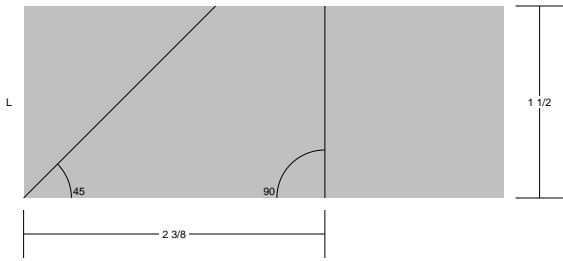
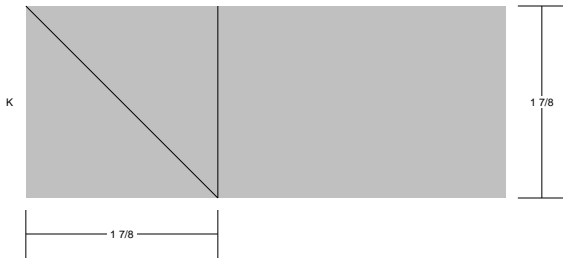

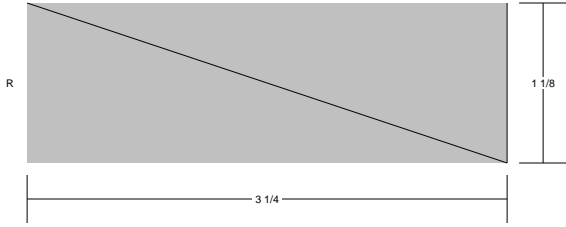
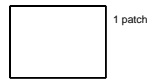
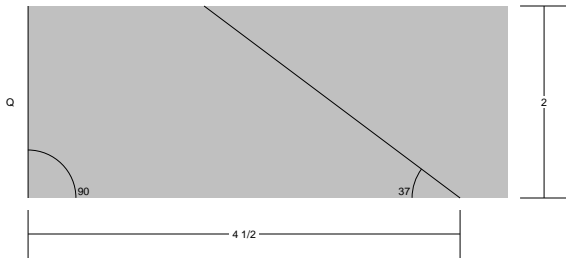

Teapot

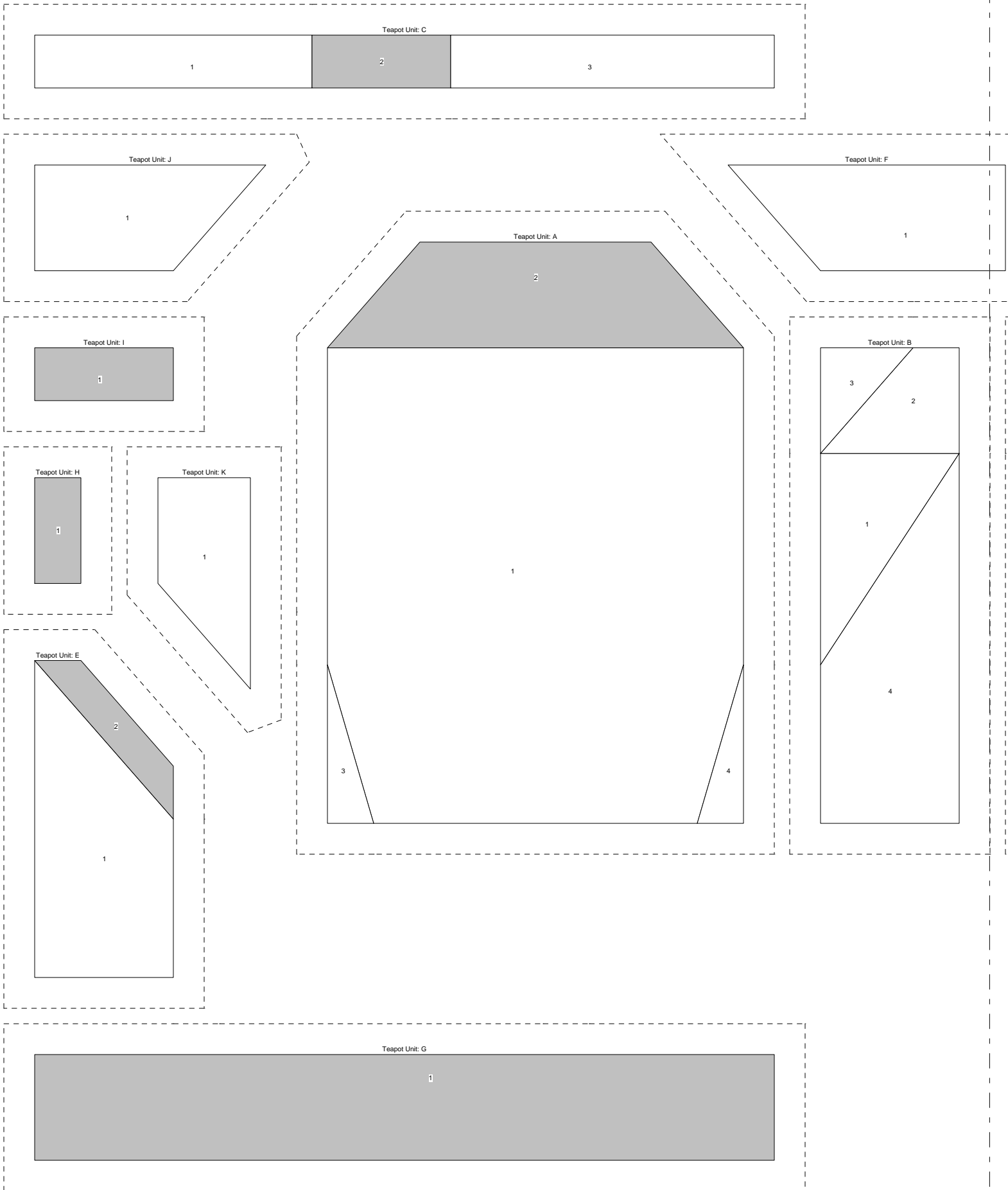

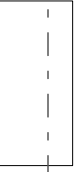

Teapot Unit: D

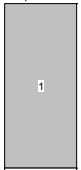

Teapot
Pattern for 8.00x7.00 block
Key Block (43/100 actual size)

