

November How-to-Quilt Patterns

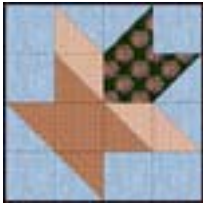

Basket of
Diamonds



Cobwebs



Darting Birds
Variation



Friendship Name
Chain



Little Lost
Sailboat

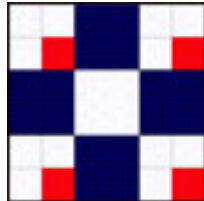

Puss in the
Corner



Rail Fence



Slanted Diamonds



Whirlygig

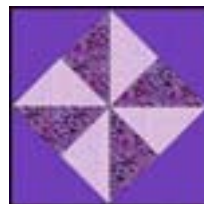

Windmill

Basket of Diamonds

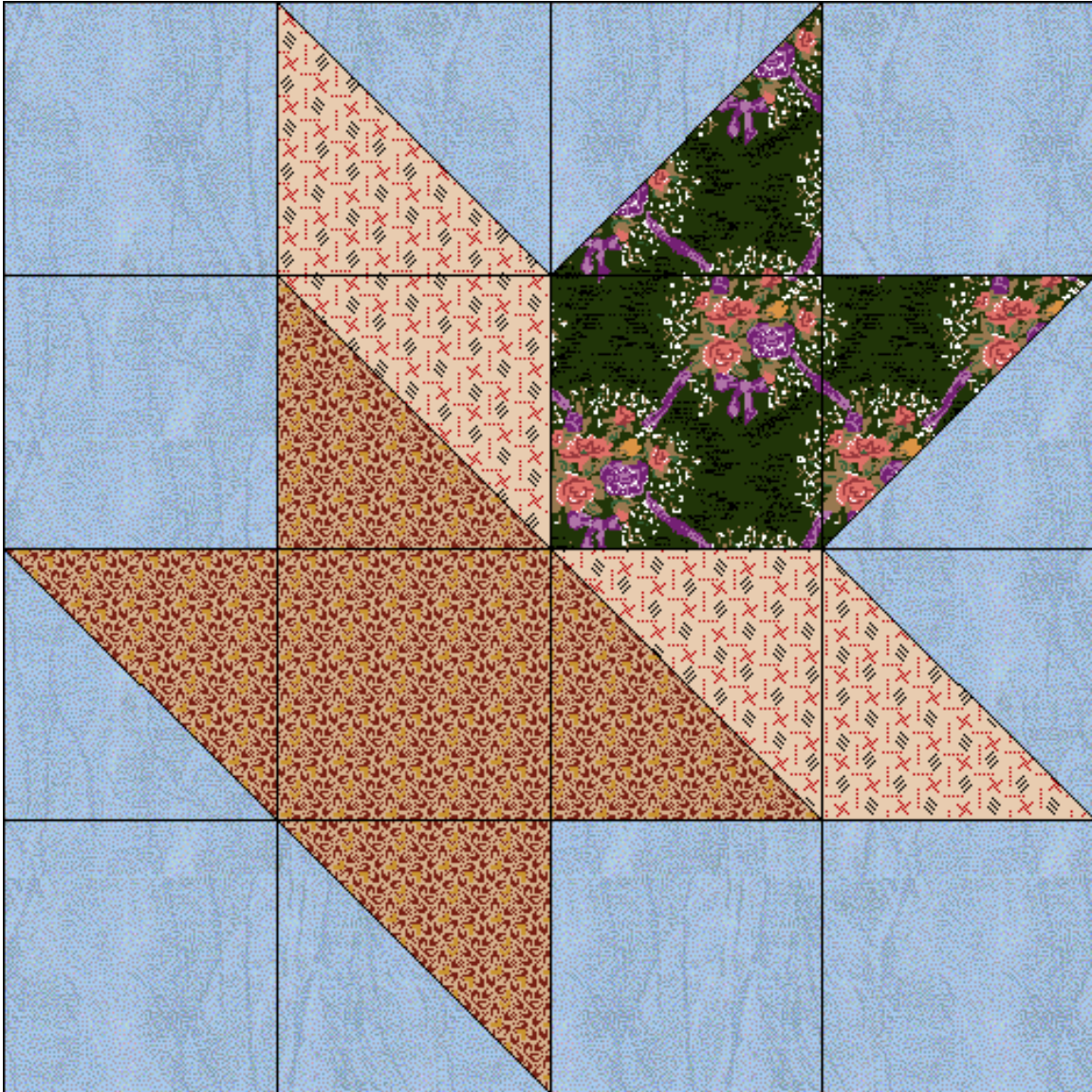

Basket of Diamonds

Pattern for 8.00x8.00 block
Key Block (2/5 actual size)

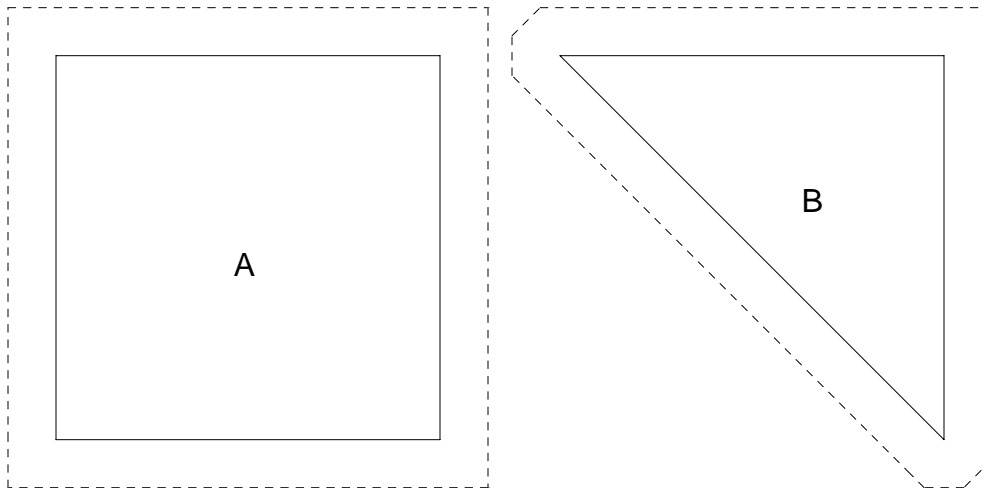
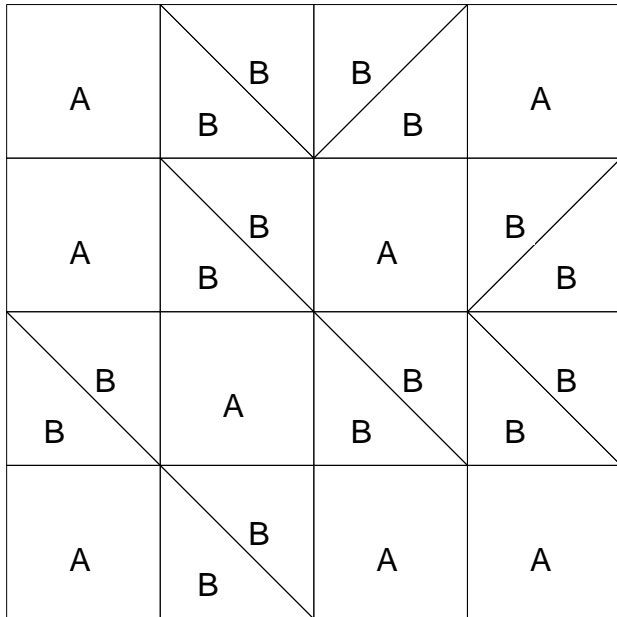

Basket of Diamonds

Pattern for 8.00x8.00 block
Key Block (31/100 actual size)

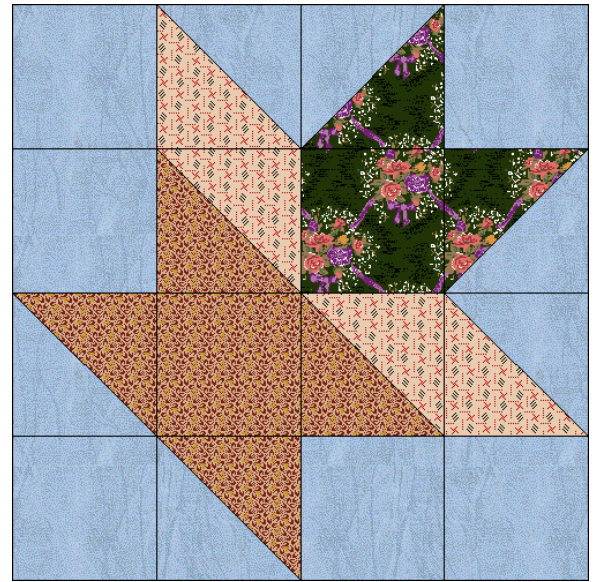
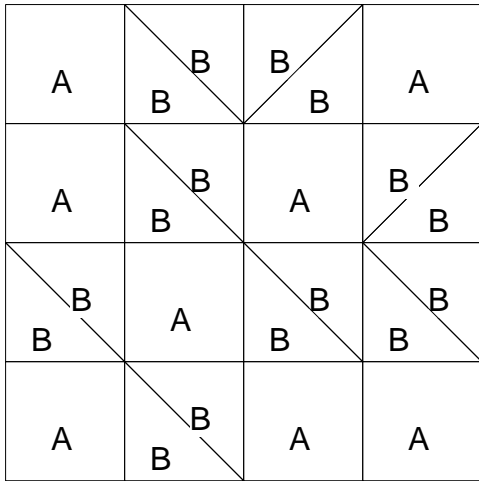

Cutting Diagrams

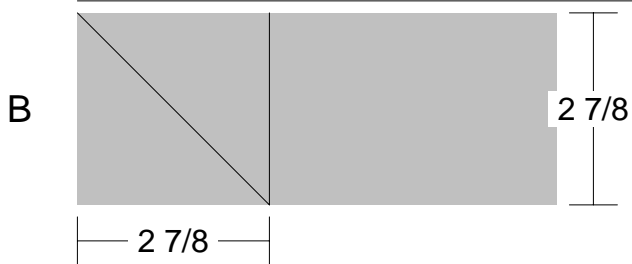

Patch Count

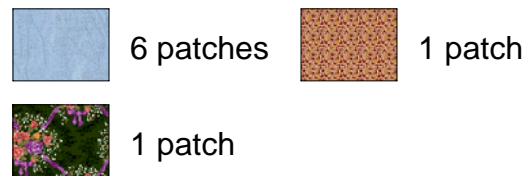

Cobwebs

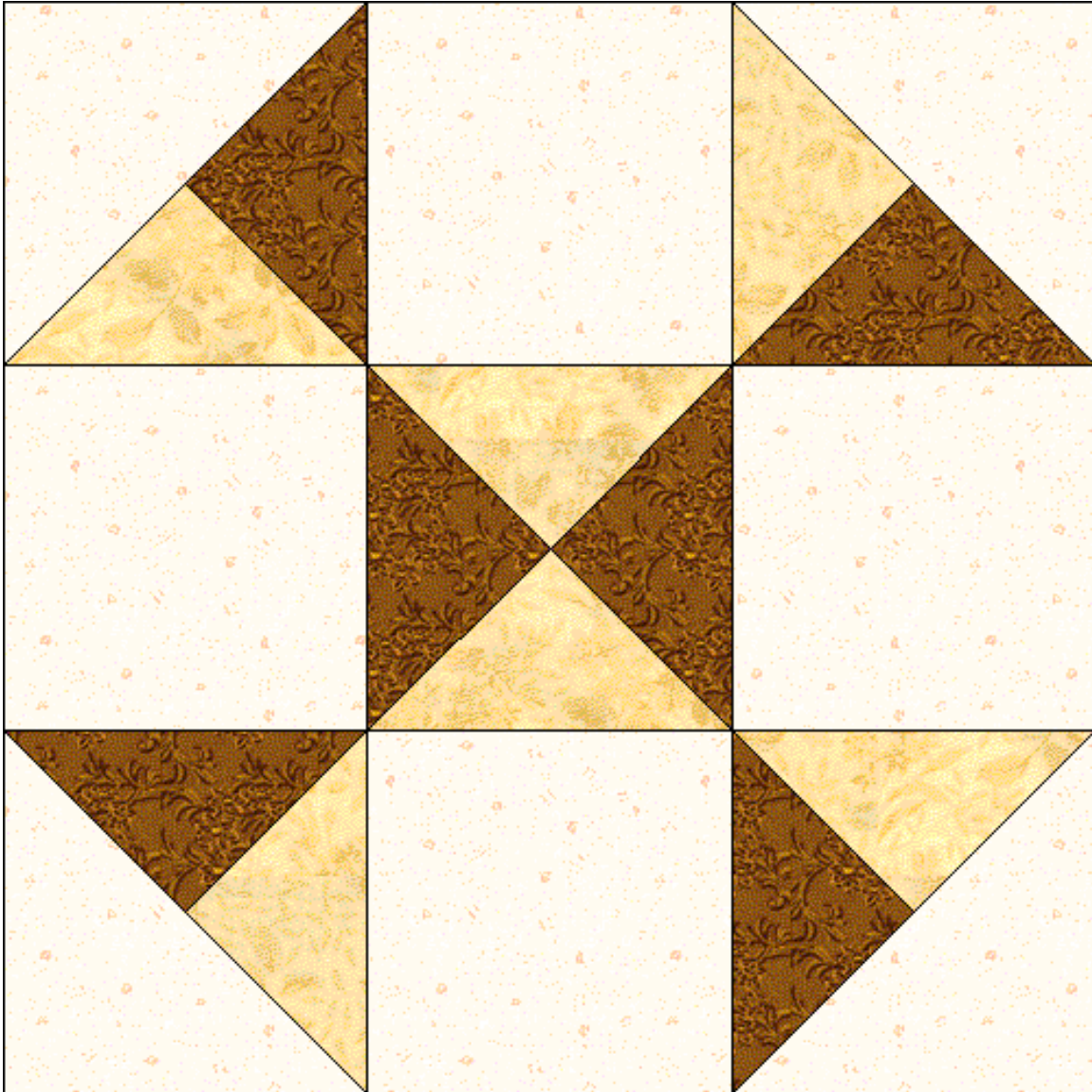

Cobwebs

Pattern for 9.00x9.00 block
Key Block (18/50 actual size)

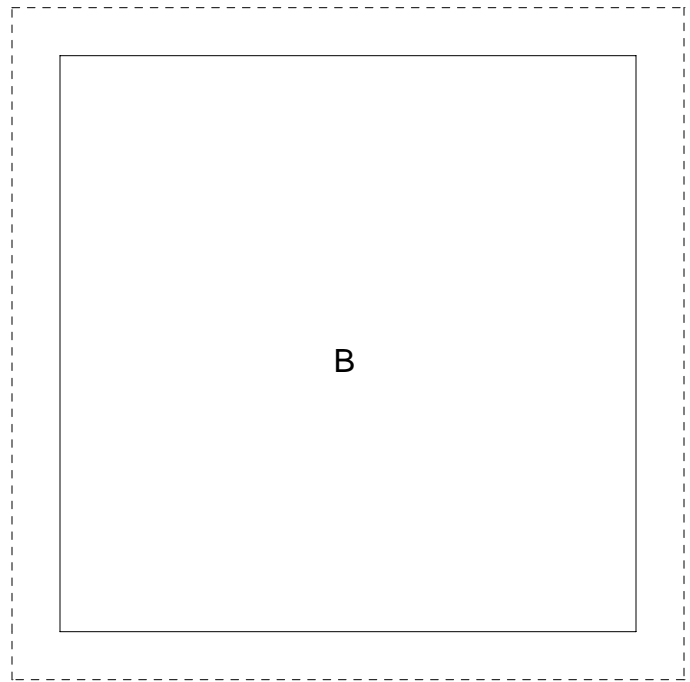
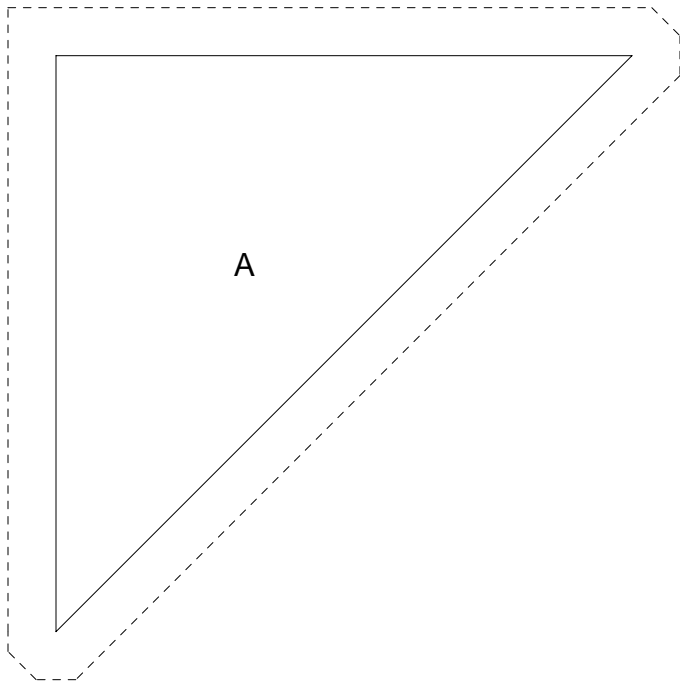
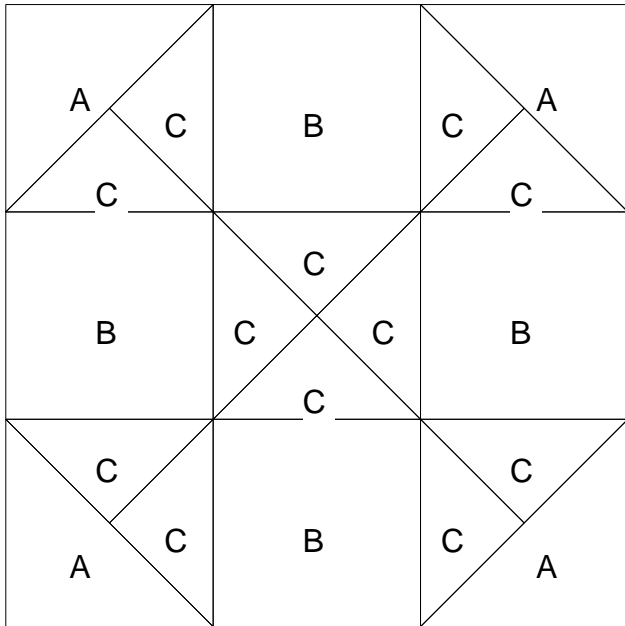

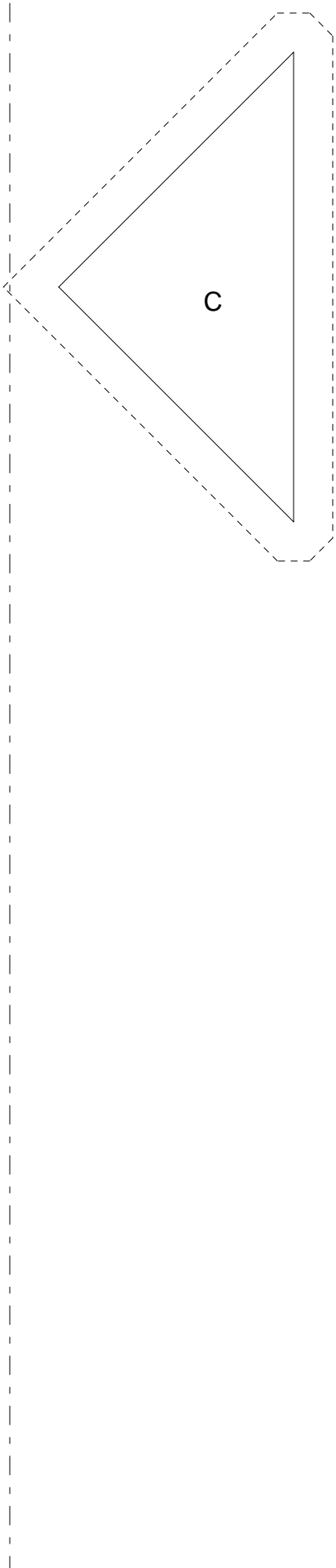

Cobwebs

Pattern for 9.00x9.00 block
Key Block (27/100 actual size)

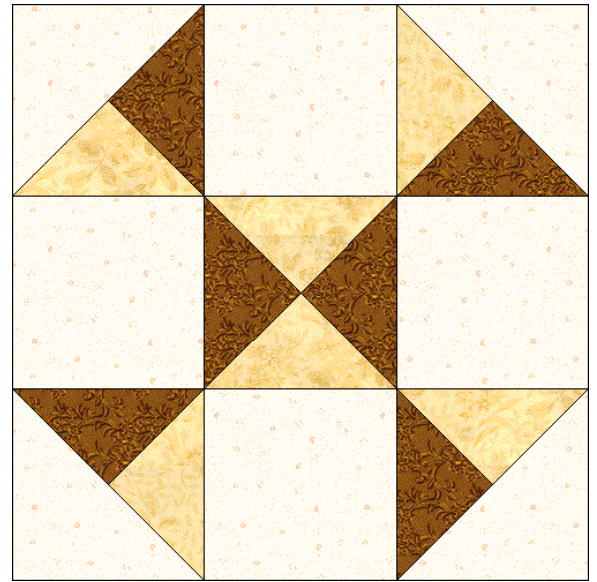
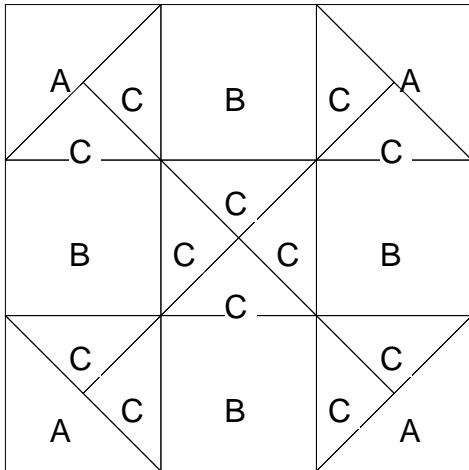

Cutting Diagrams

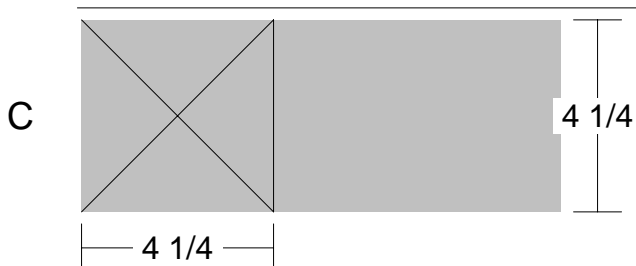
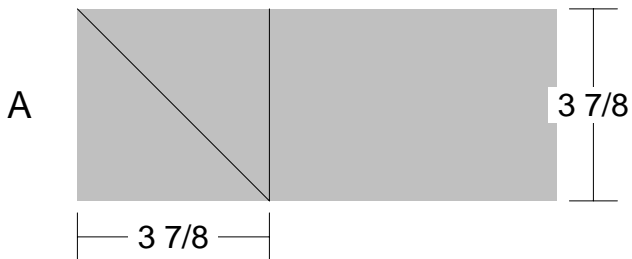

Patch Count

Darting Birds

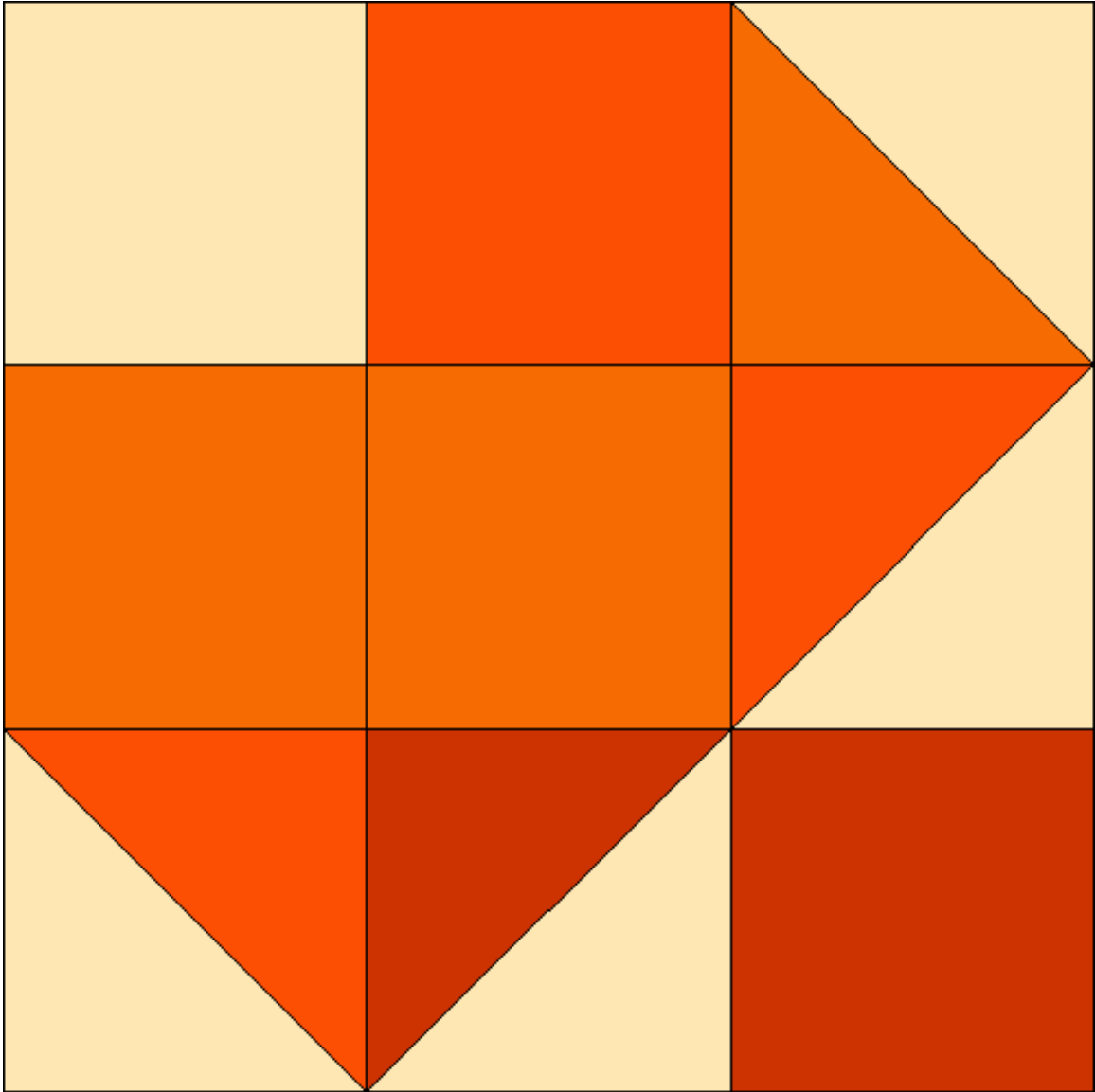

Darting Birds

Pattern for 9.00x9.00 block
Key Block (18/50 actual size)

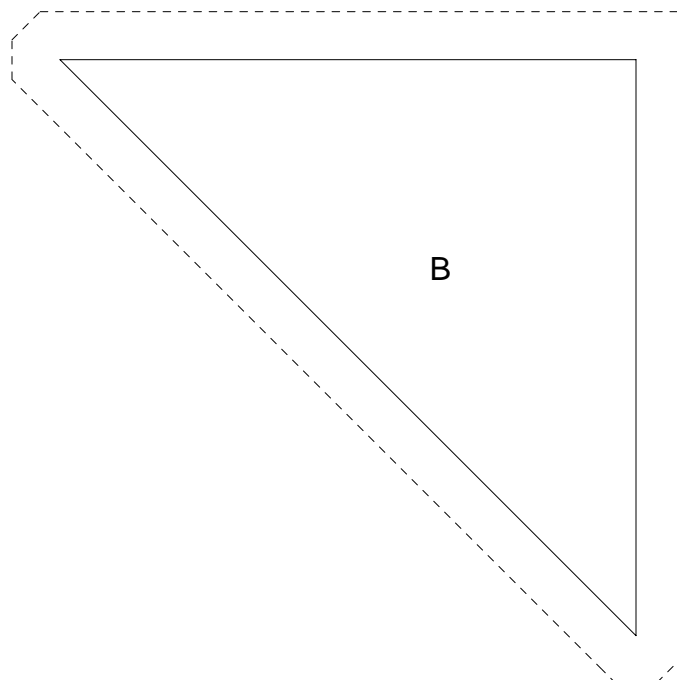
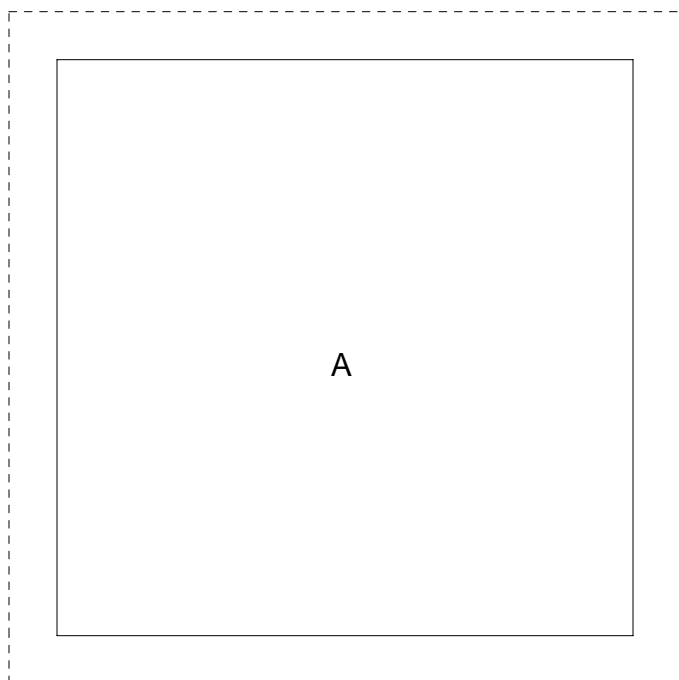
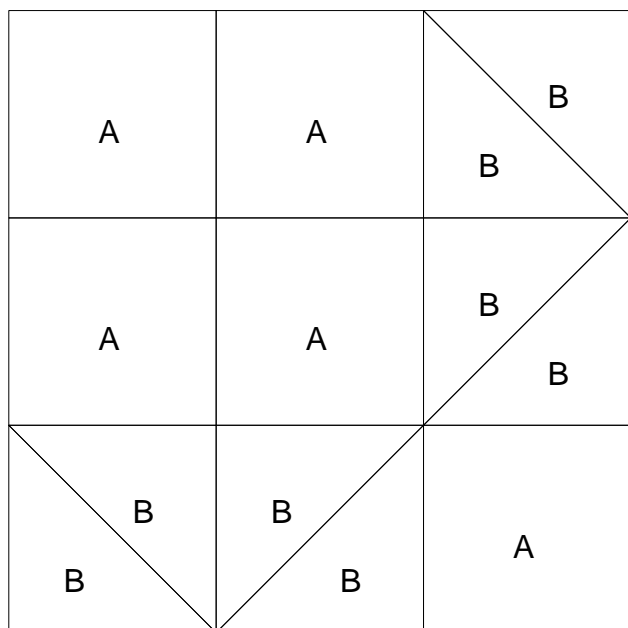

Darting Birds

Pattern for 9.00x9.00 block
Key Block (27/100 actual size)

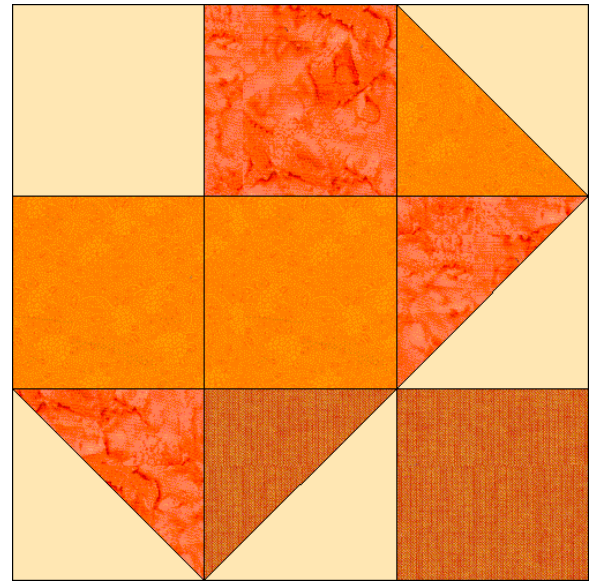
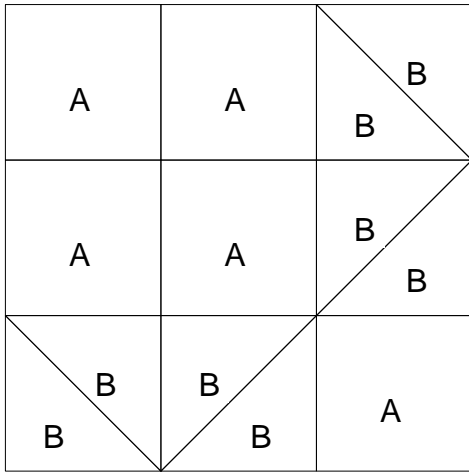

Cutting Diagrams

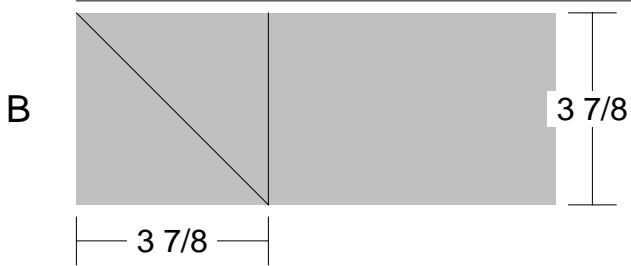

Patch Count

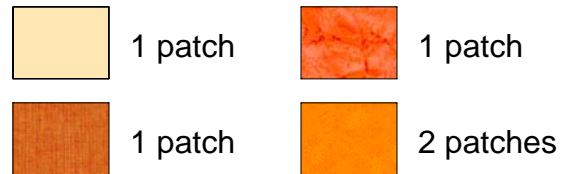

Friendship Name Chain

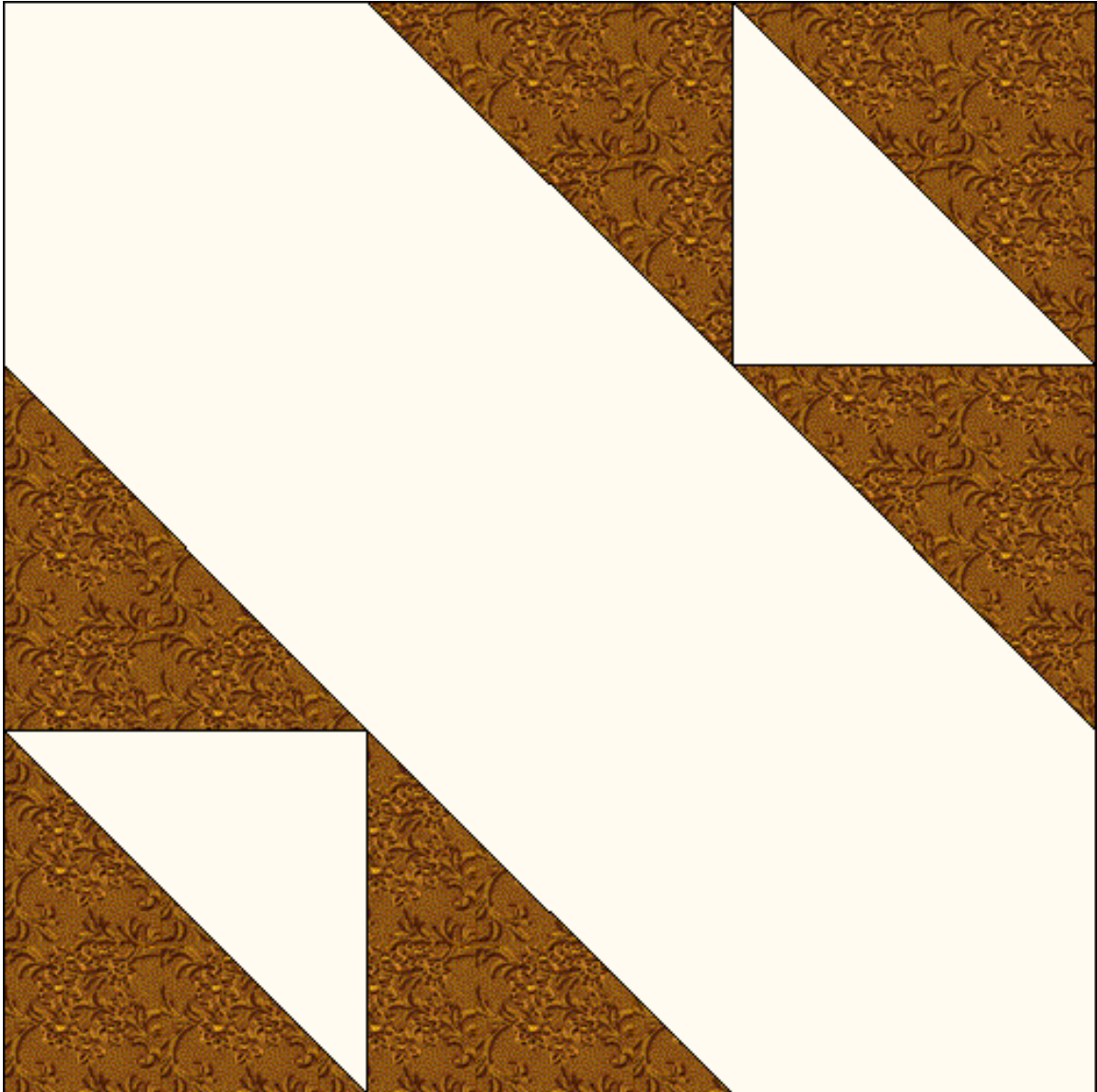

Friendship Name Chain

Pattern for 9.00x9.00 block
Key Block (18/50 actual size)

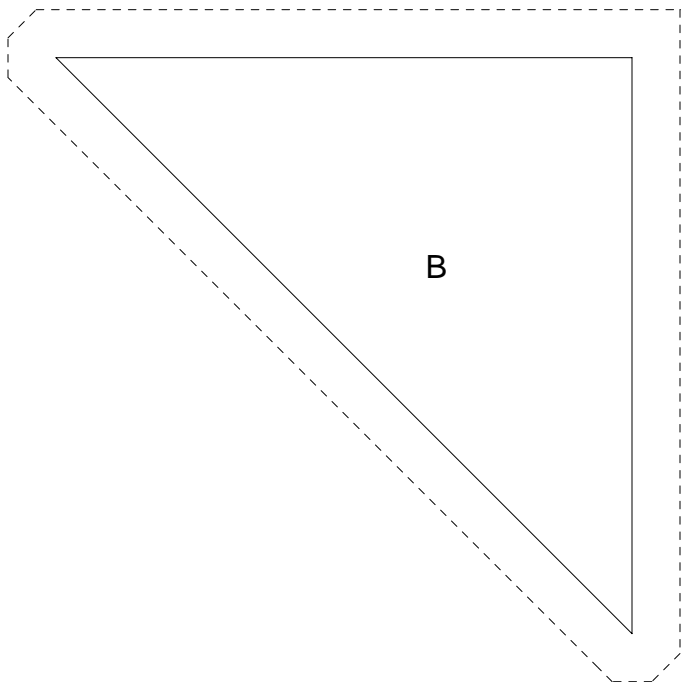
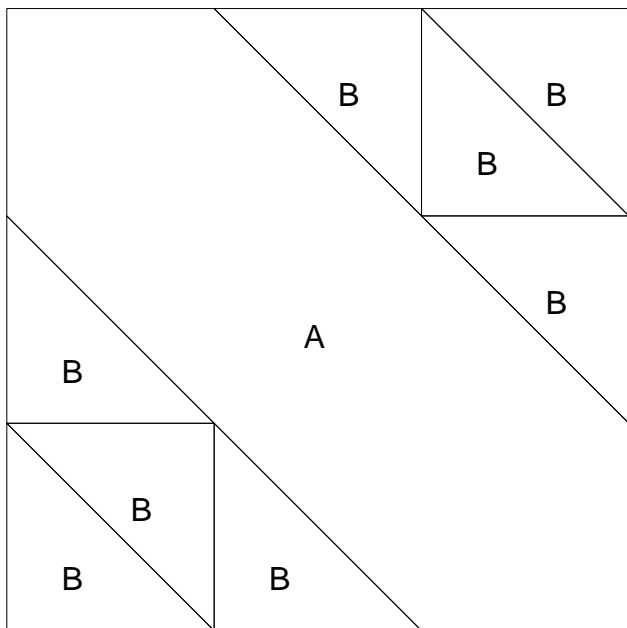

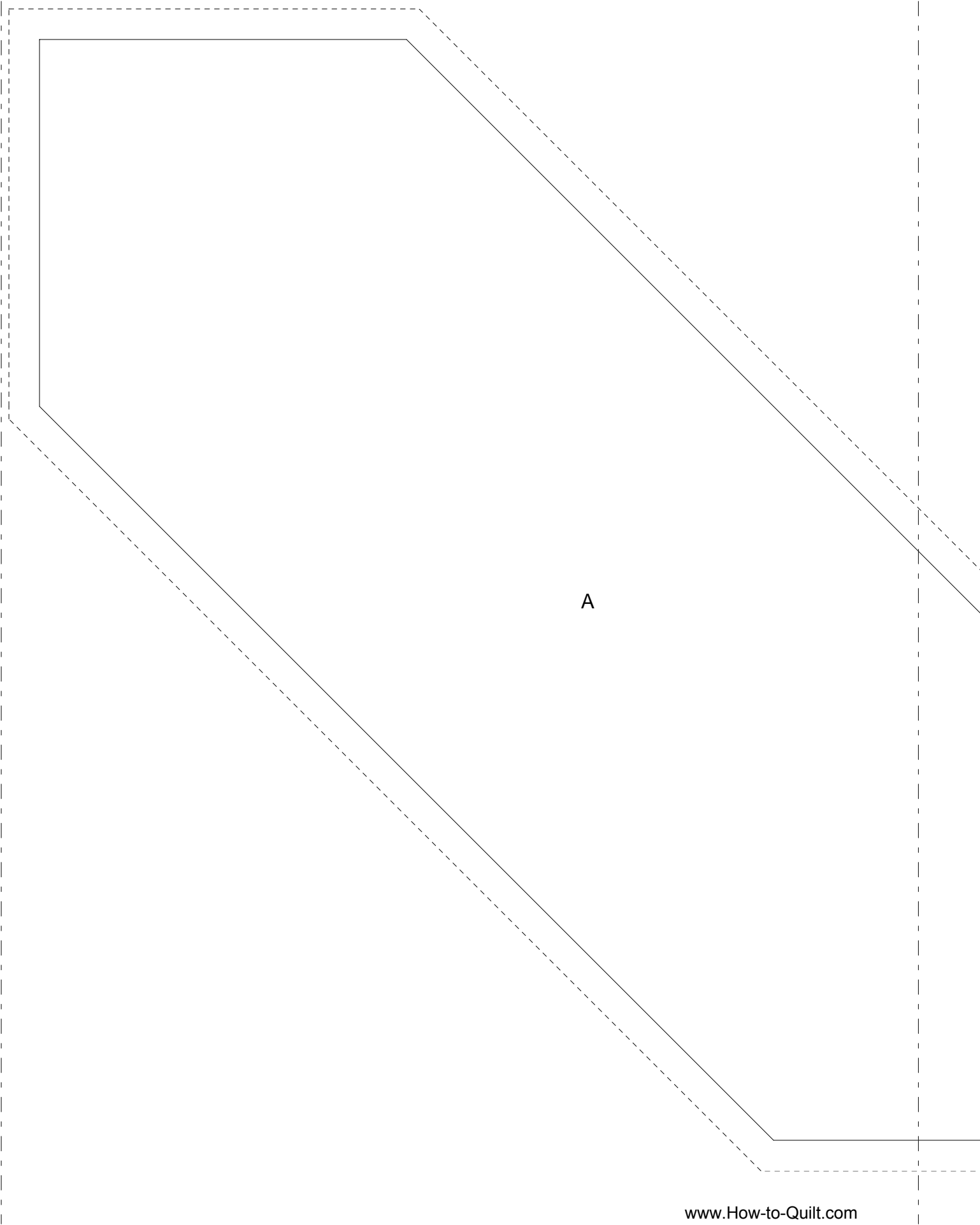

A

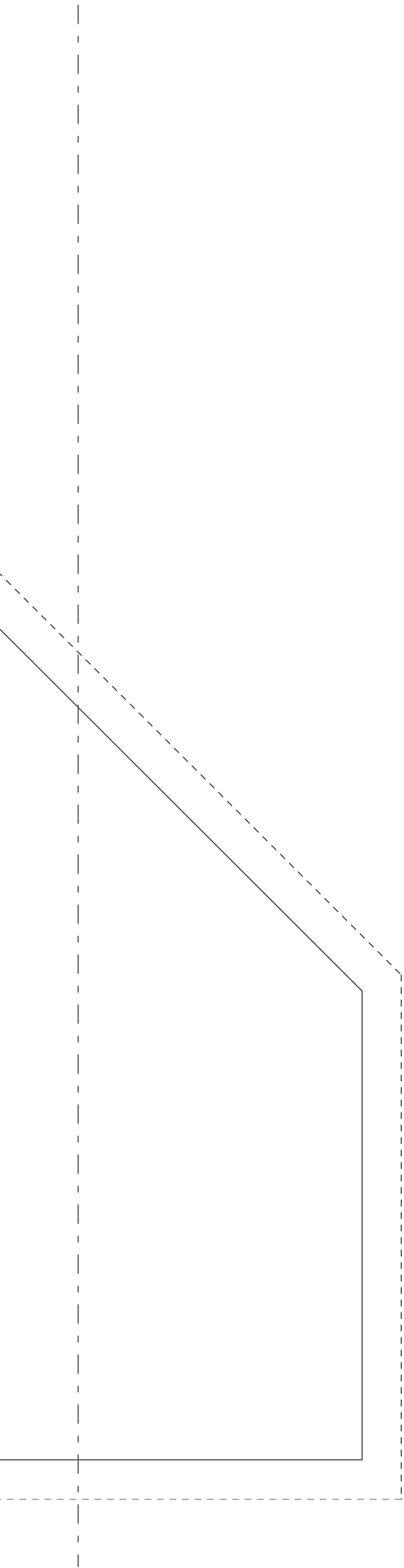

Friendship Name Chain

Pattern for 9.00x9.00 block
Key Block (27/100 actual size)

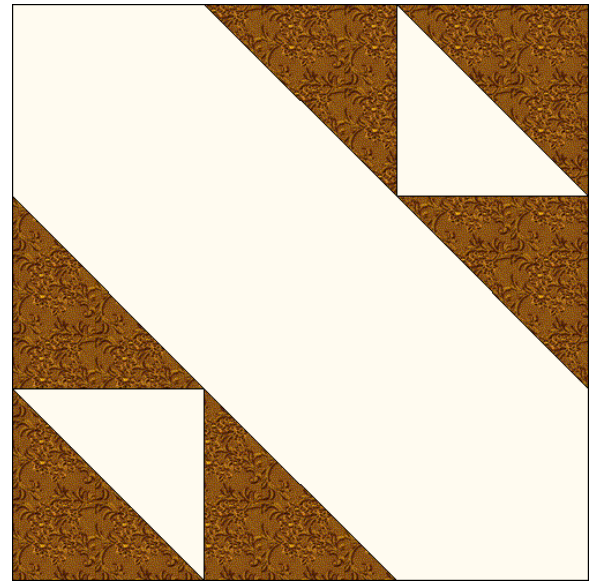
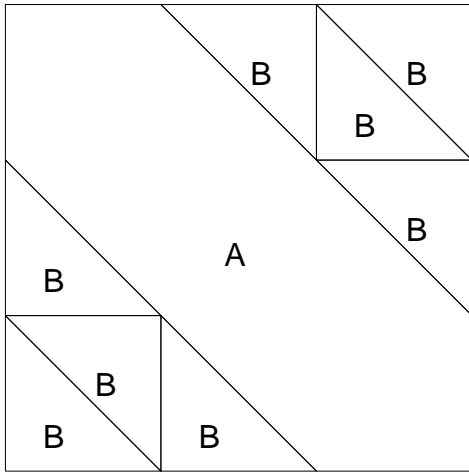

Cutting Diagrams

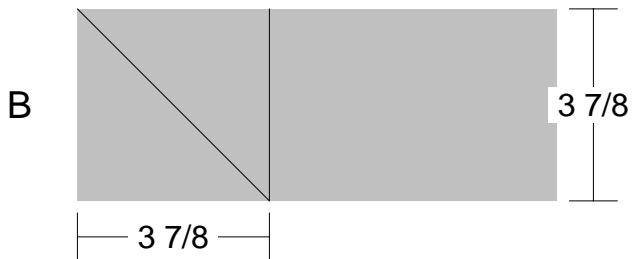

Patch Count



Little Lost Sailboat

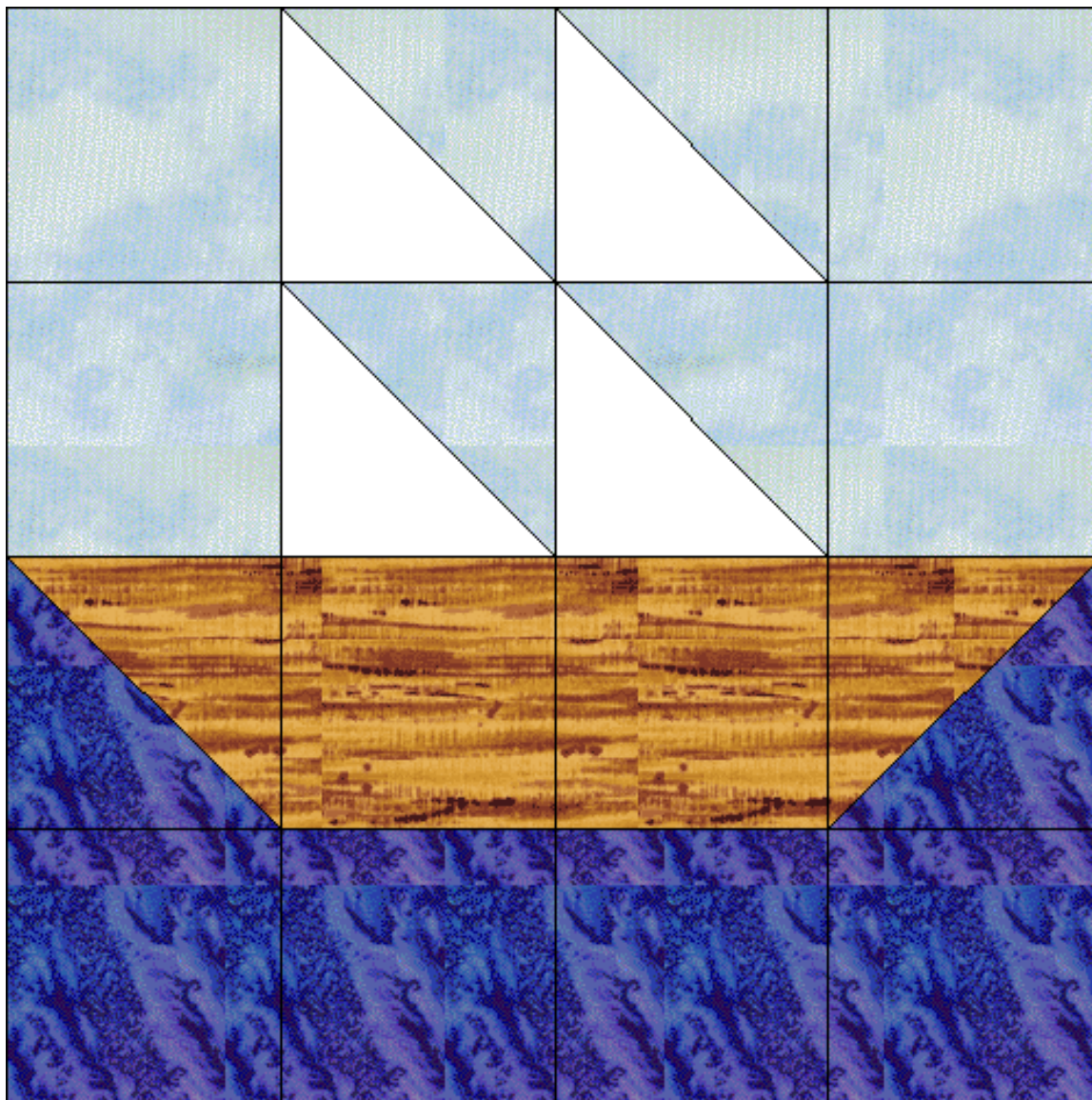

Little Lost Sailboat

Pattern for 8.00x8.00 block
Key Block (2/5 actual size)

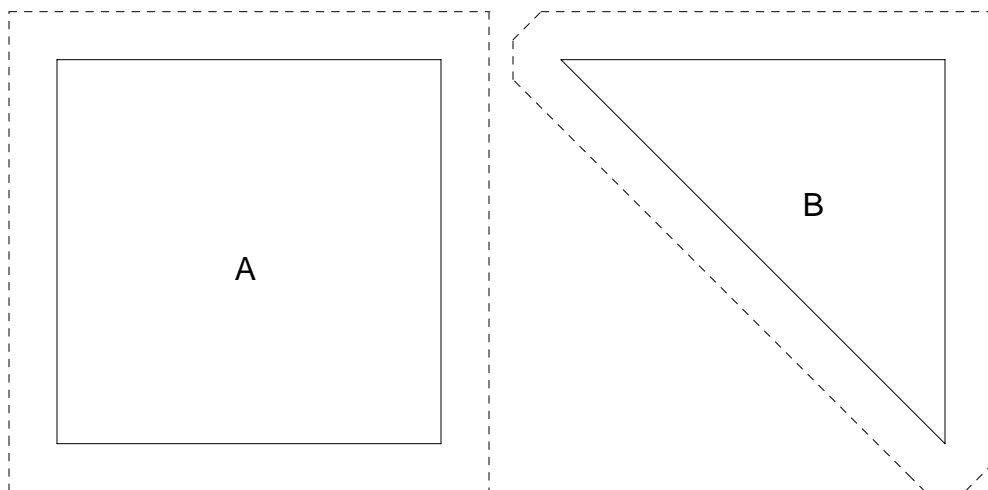
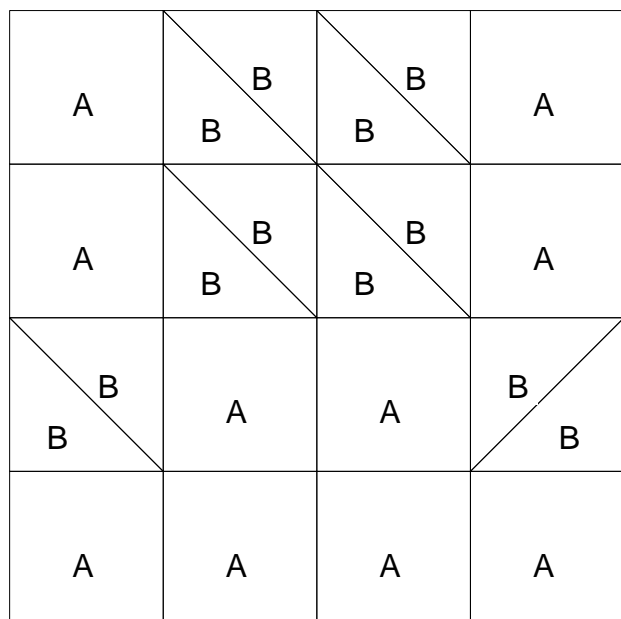

Little Lost Sailboat

Pattern for 8.00x8.00 block
Key Block (31/100 actual size)

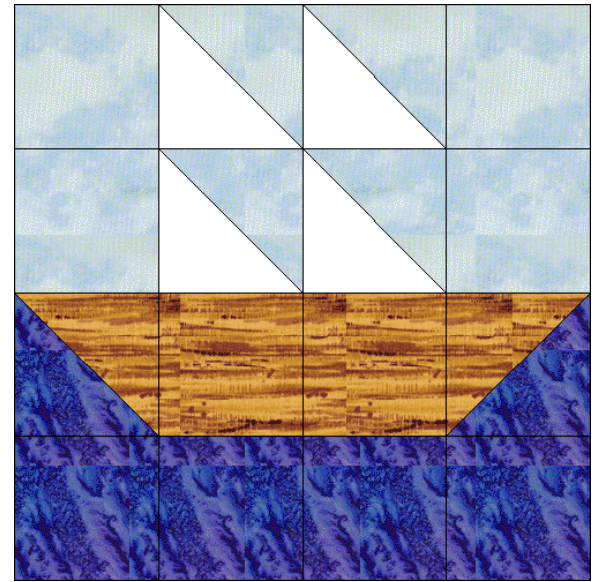
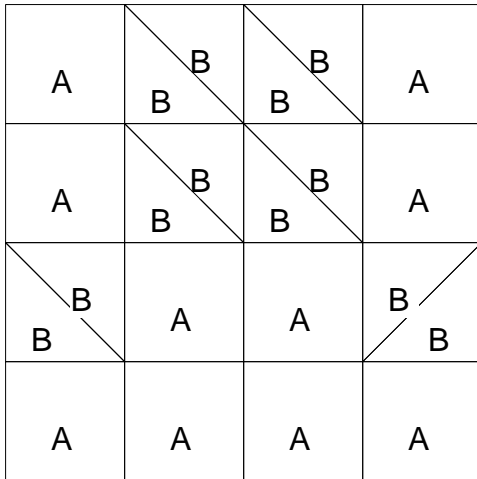

Cutting Diagrams

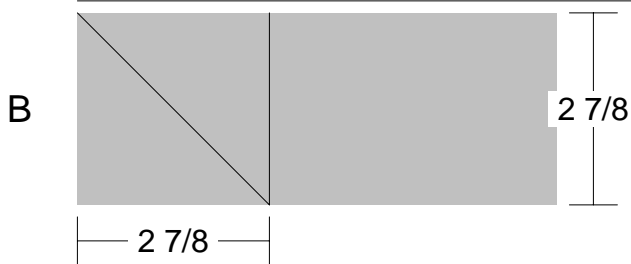
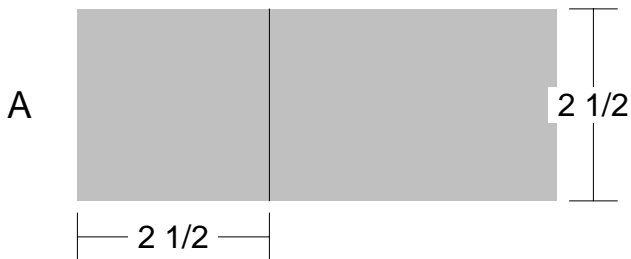

Patch Count



Puss in the Corner

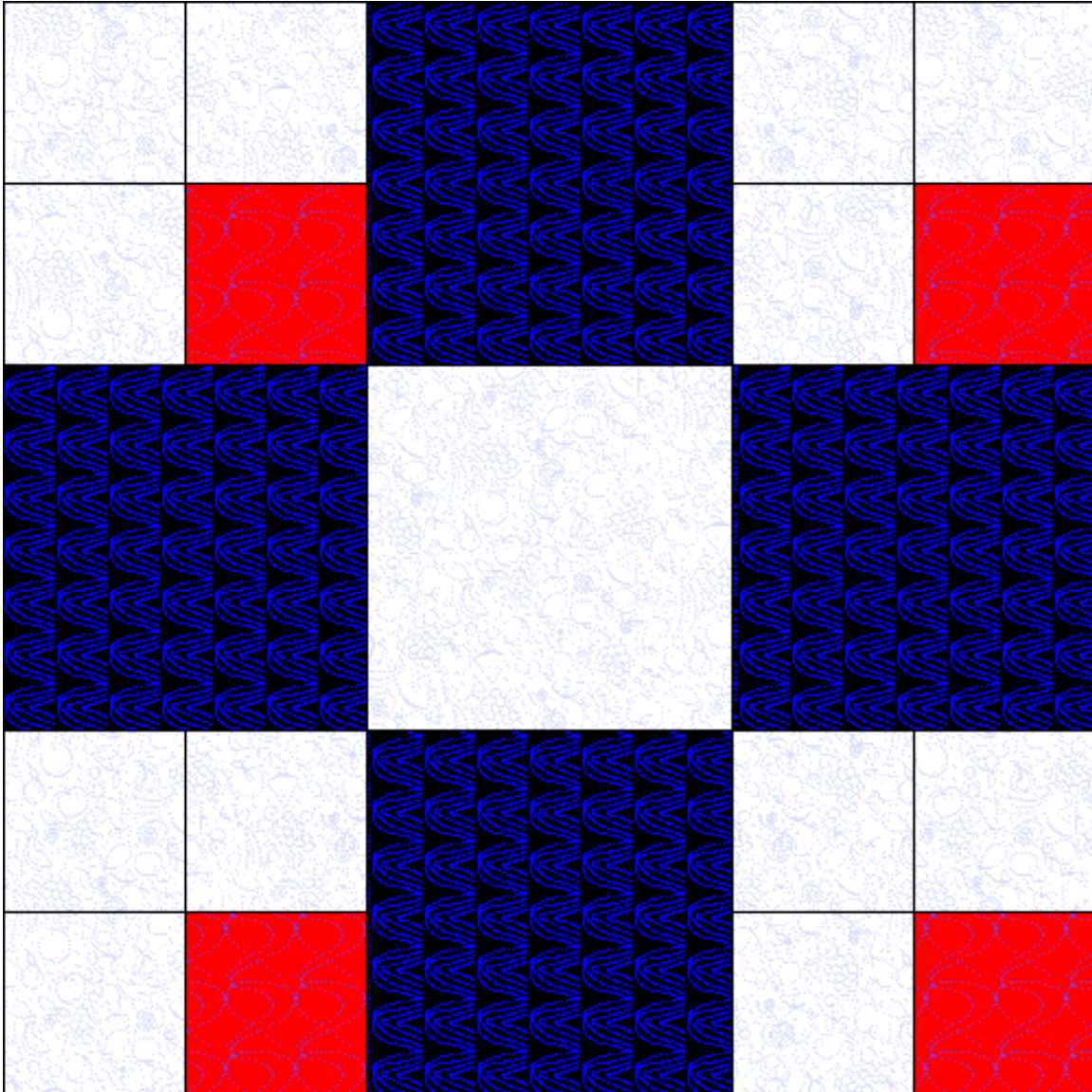

Puss in the Corner
Pattern for 12.00x12.00 block
Key Block (27/100 actual size)

A	A	B	A	A
A	A		A	A
B		B	B	
A	A	B	A	A
A	A		A	A

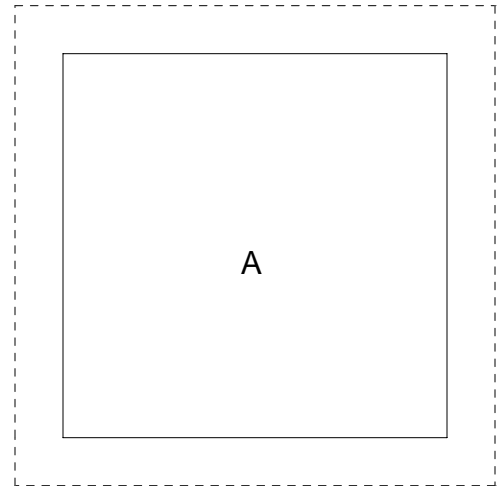
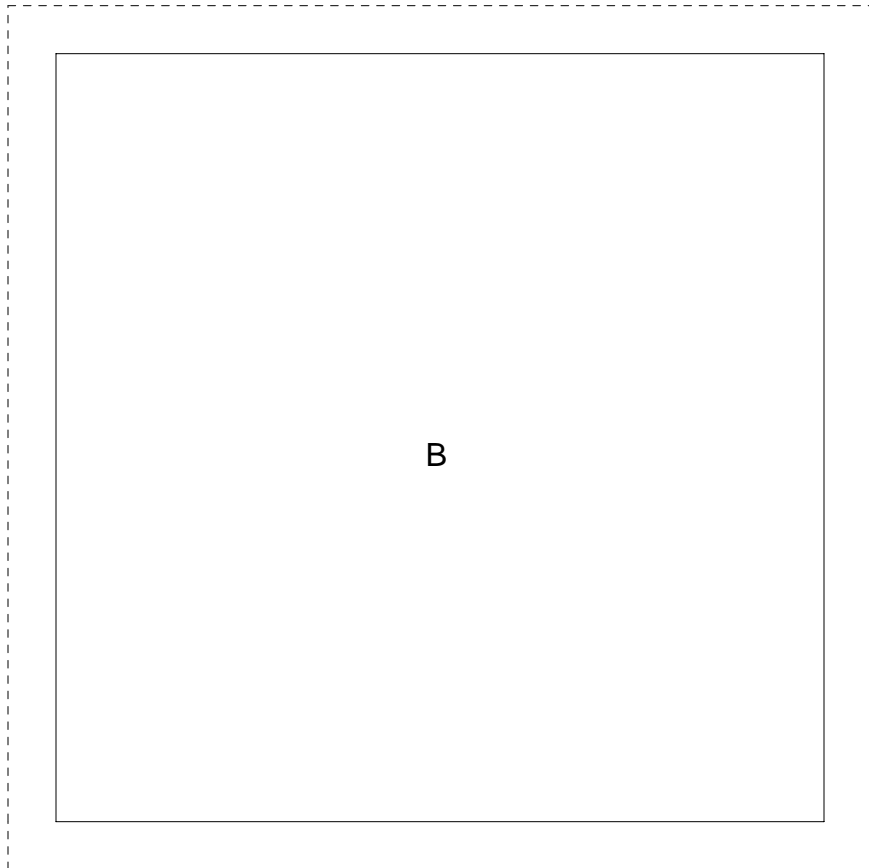

Puss in the Corner

Pattern for 12.00x12.00 block
Key Block (1/5 actual size)

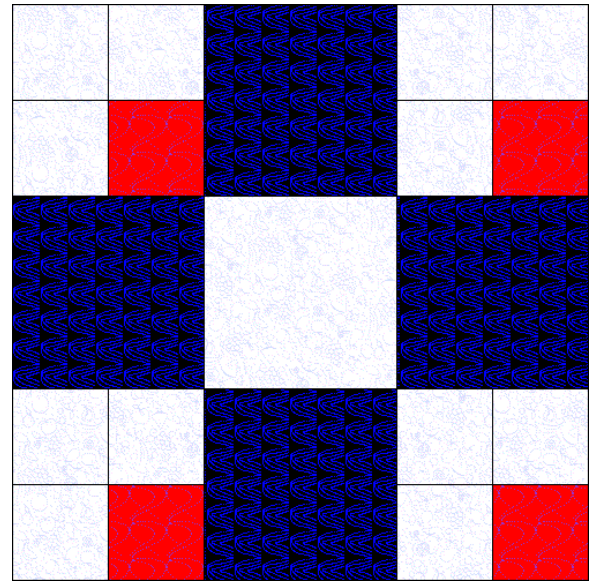
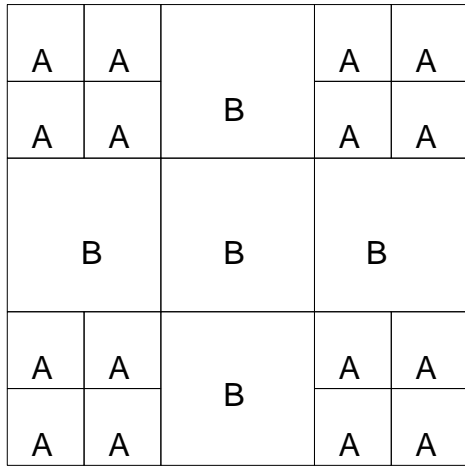

Cutting Diagrams

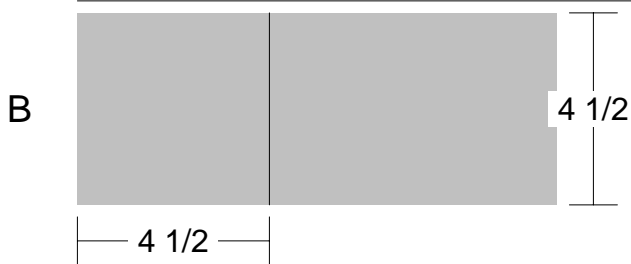
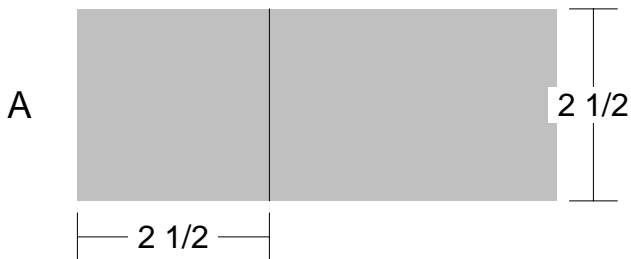

Patch Count



Rail Fence

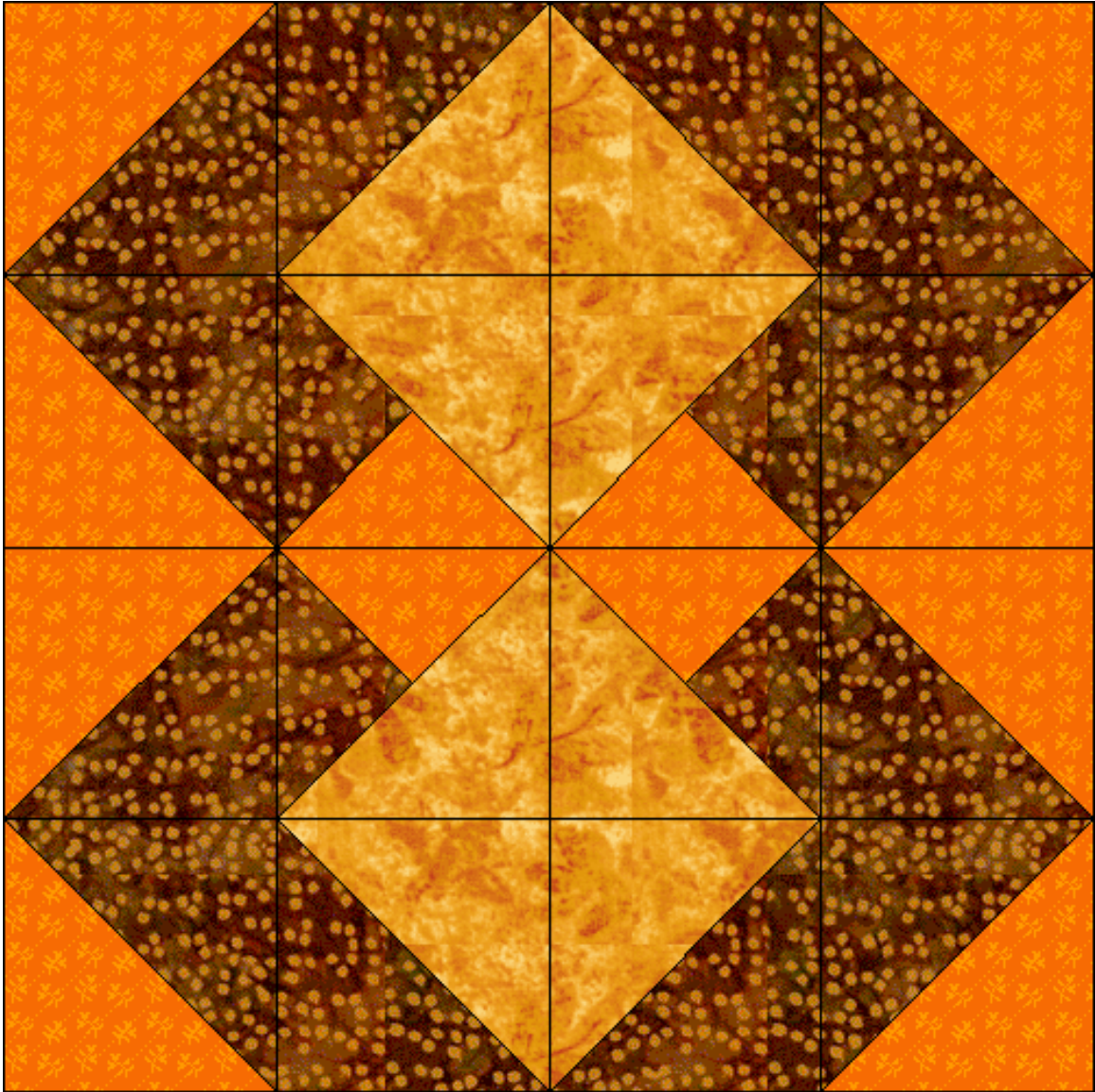

Rail Fence

Pattern for 8.00x8.00 block
Key Block (2/5 actual size)

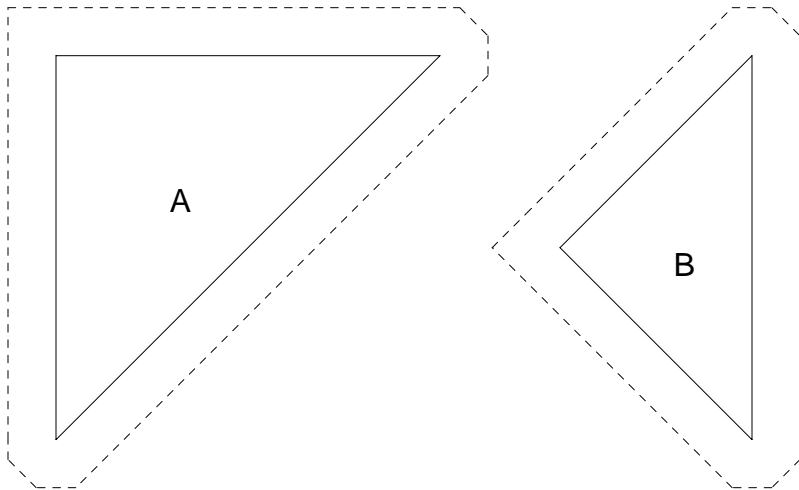
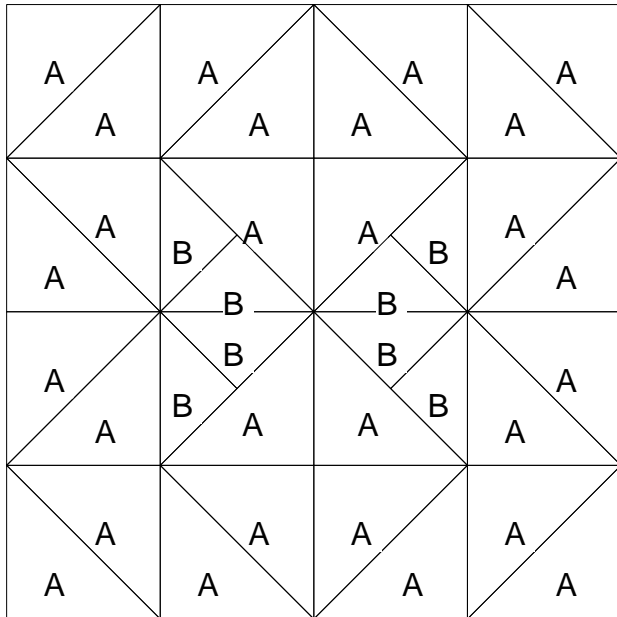

Rail Fence

Pattern for 8.00x8.00 block
Key Block (31/100 actual size)

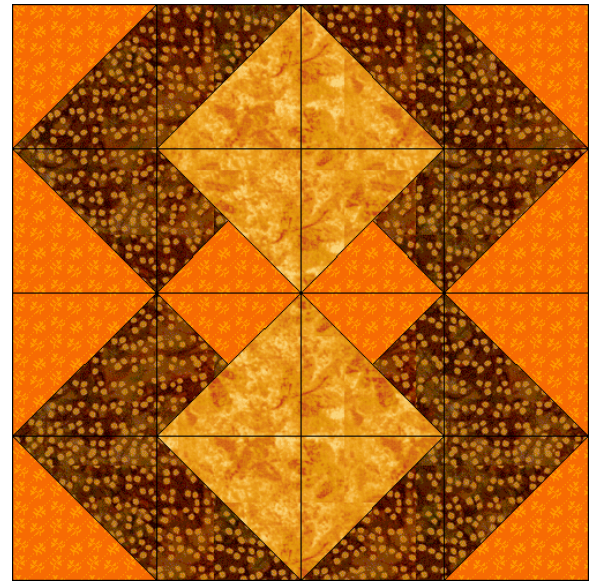
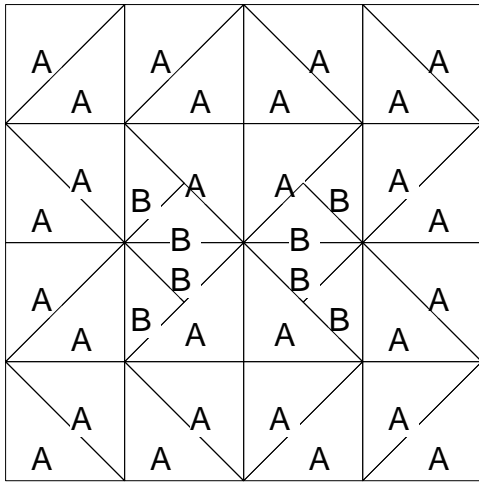

Cutting Diagrams

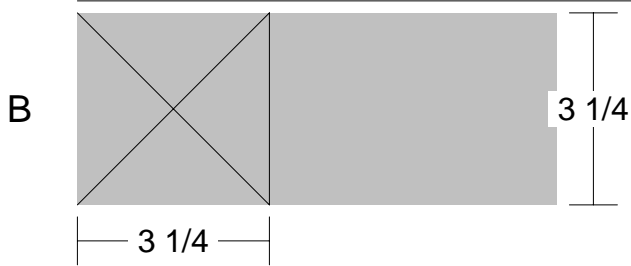
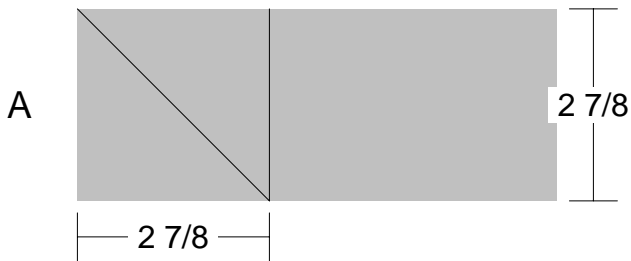

Patch Count

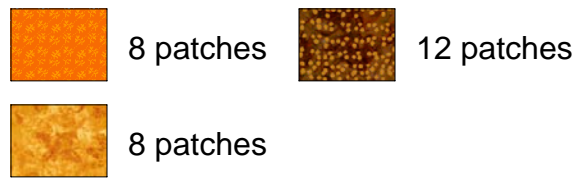

Slanted Diamonds

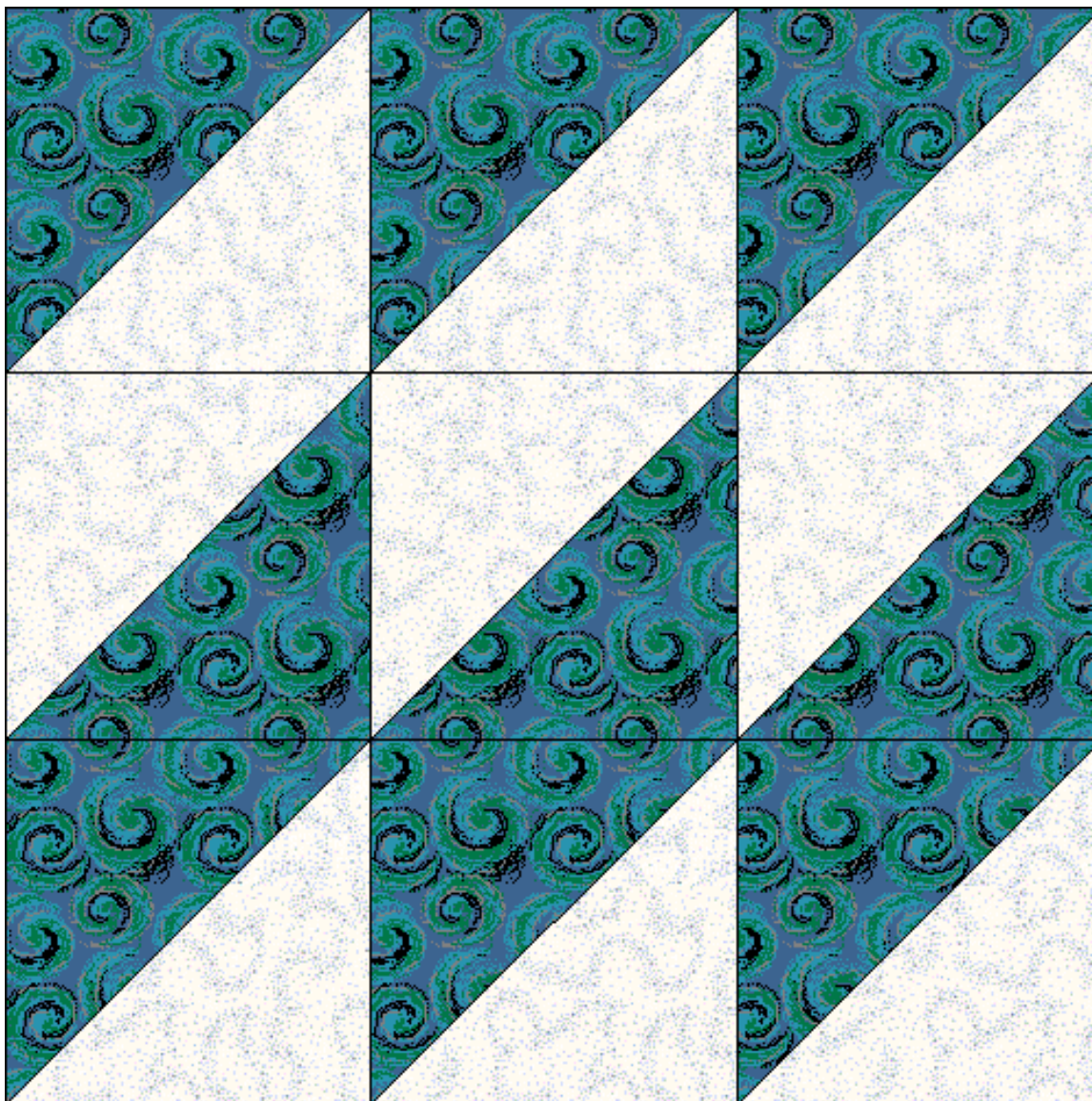

Slanted Diamonds

Pattern for 9.00x9.00 block
Key Block (18/50 actual size)

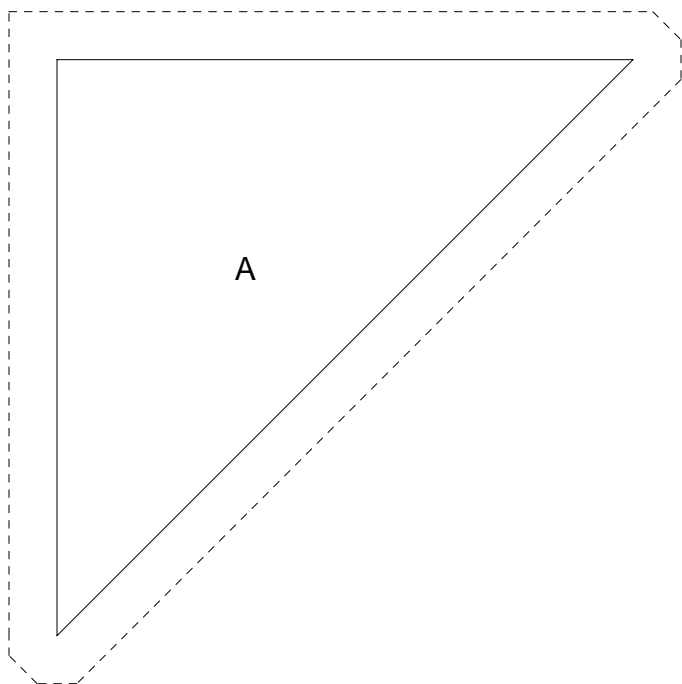
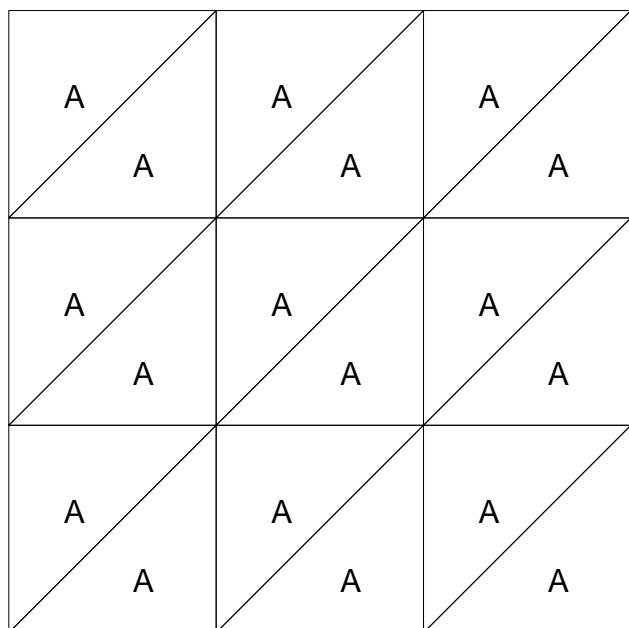

Slanted Diamonds

Pattern for 9.00x9.00 block
Key Block (27/100 actual size)

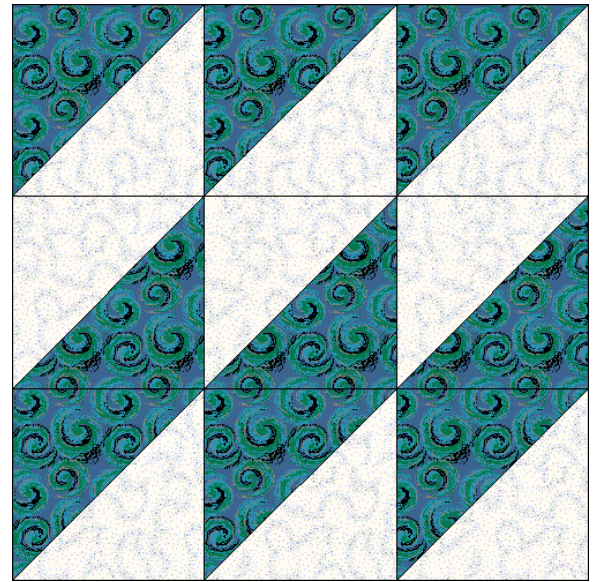
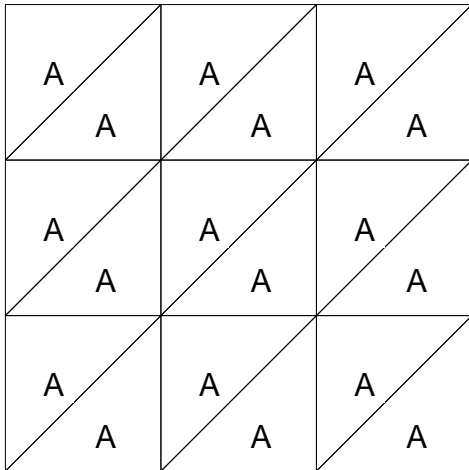

Cutting Diagrams

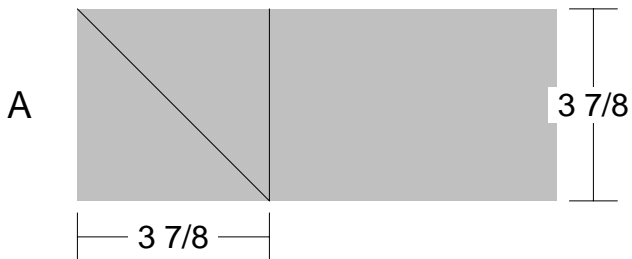

Patch Count



Whirlygig

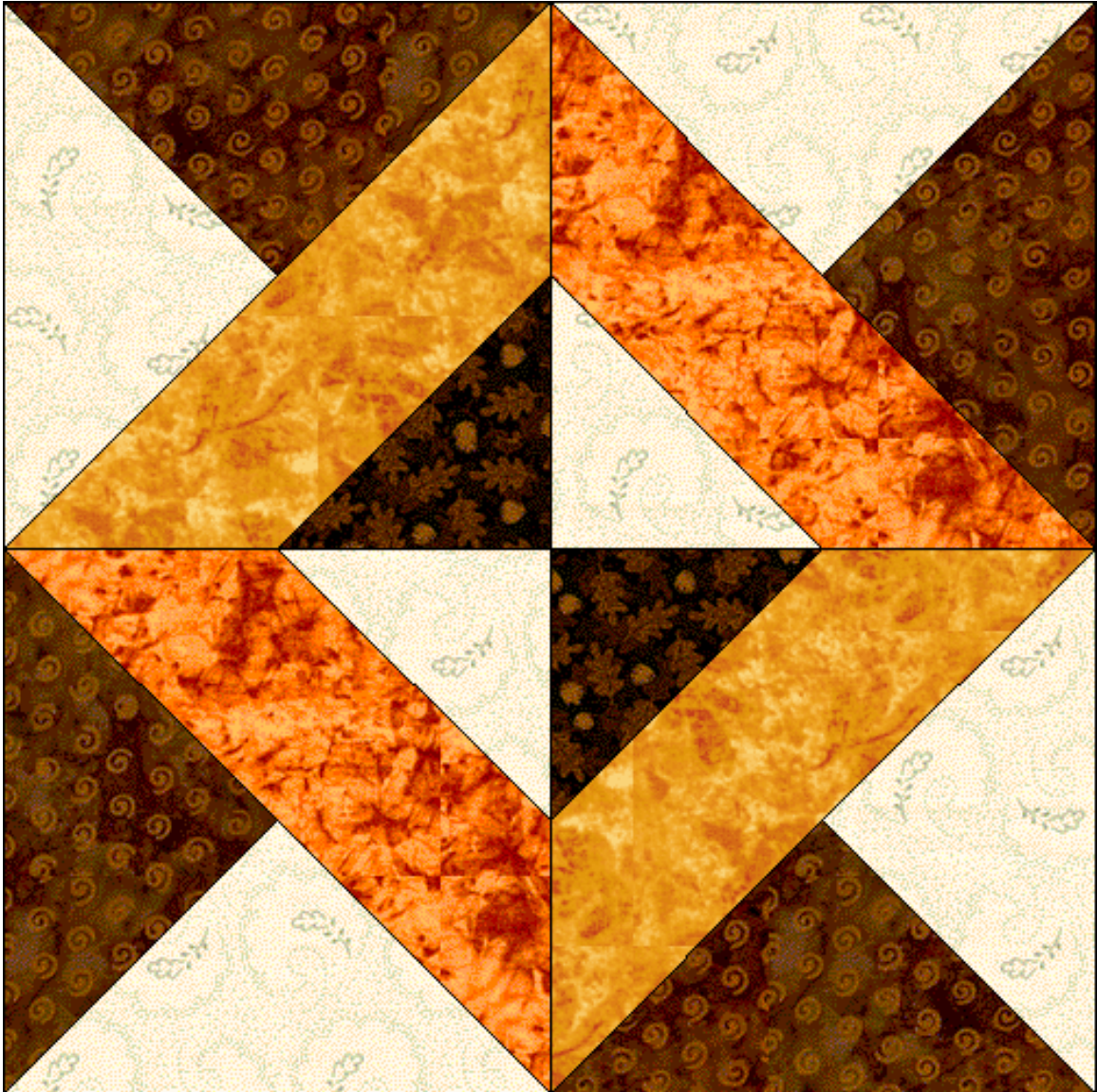

Whirlygig

Pattern for 8.00x8.00 block
Key Block (2/5 actual size)

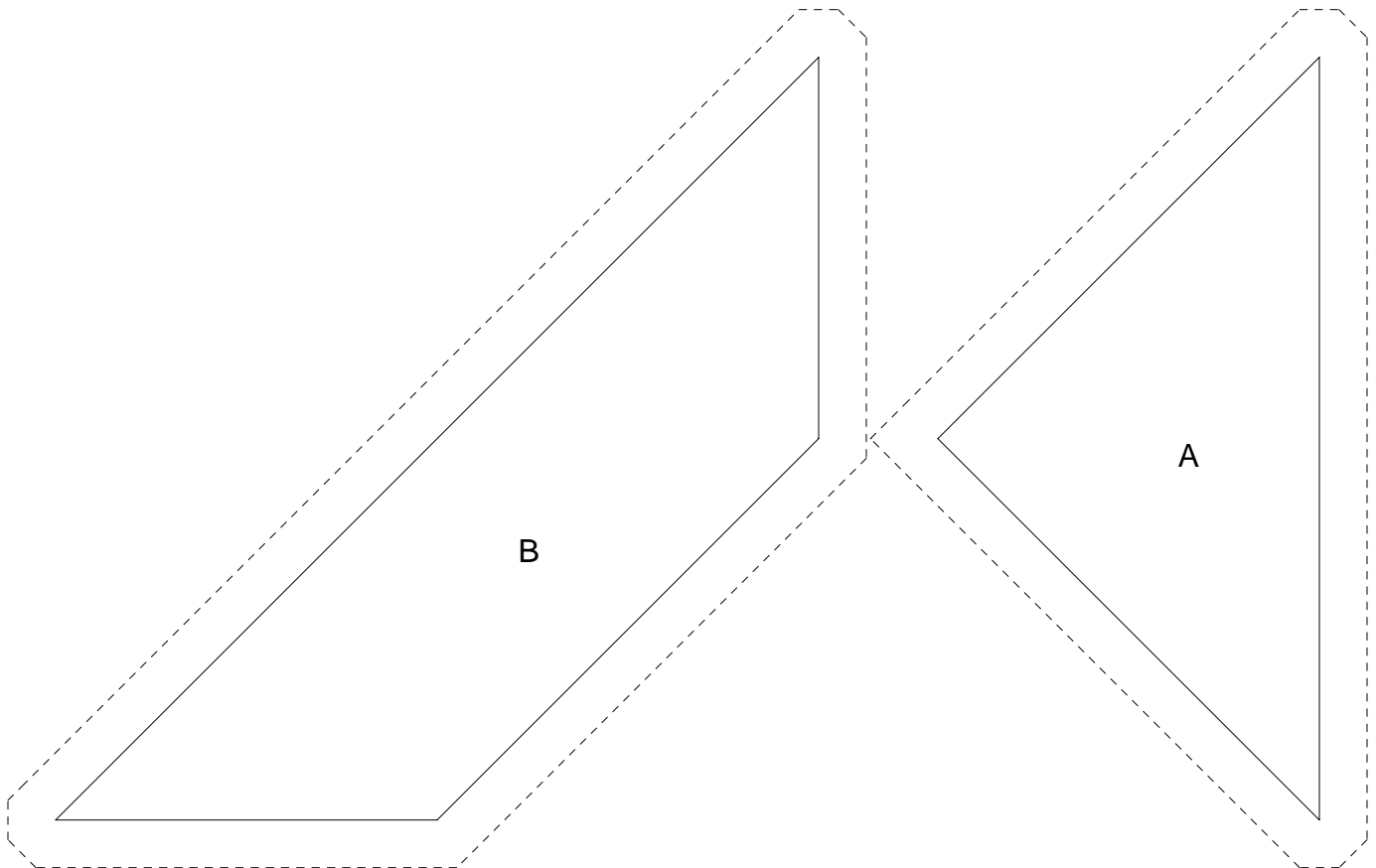
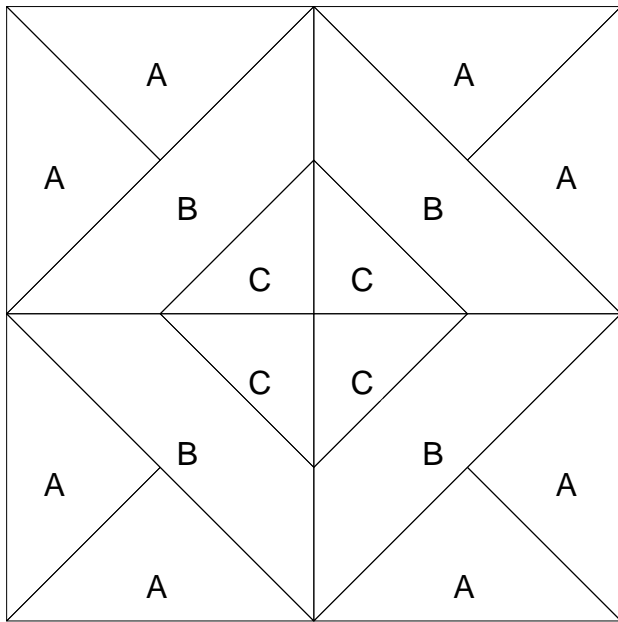

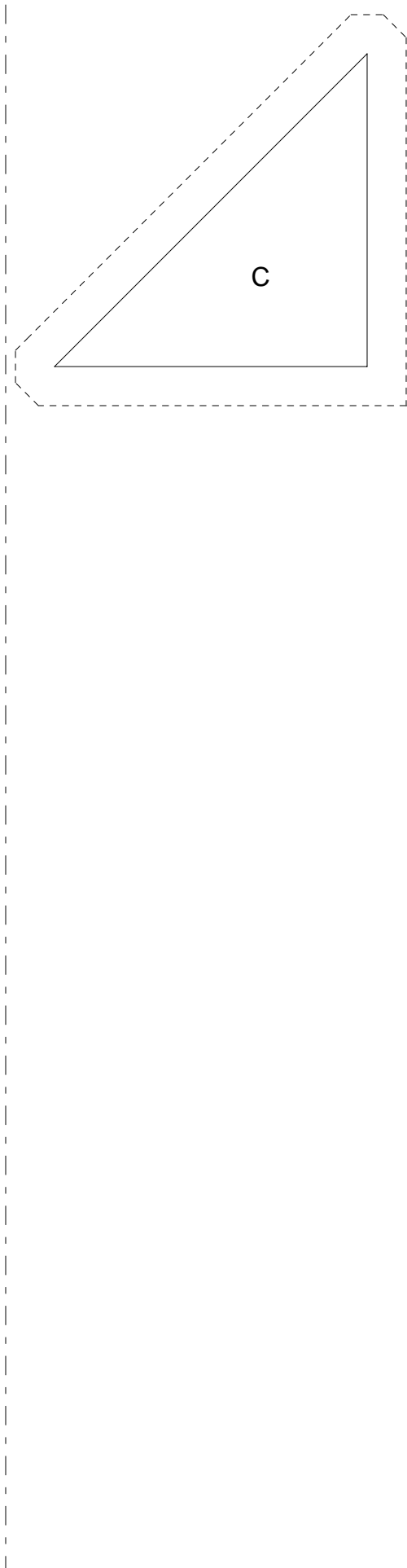

Whirlygig

Pattern for 8.00x8.00 block
Key Block (31/100 actual size)

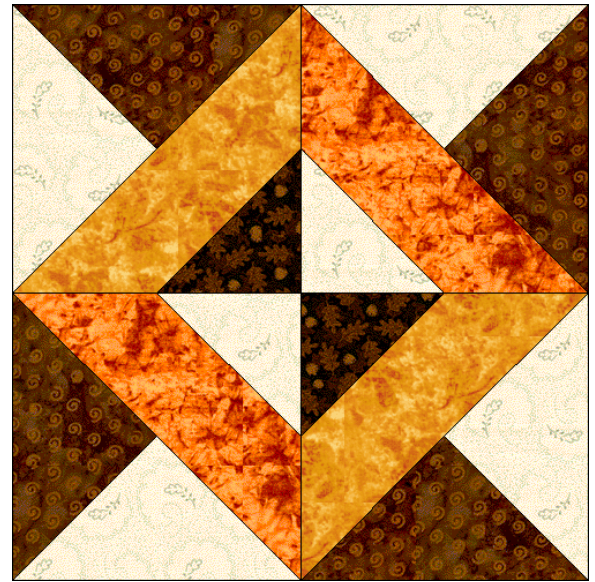
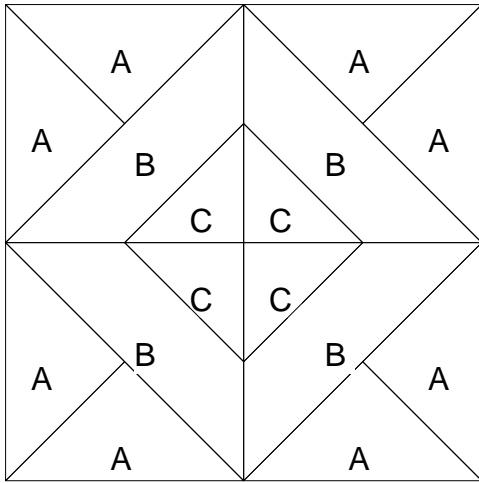

Cutting Diagrams

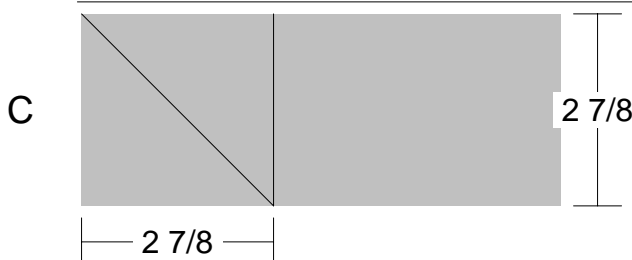
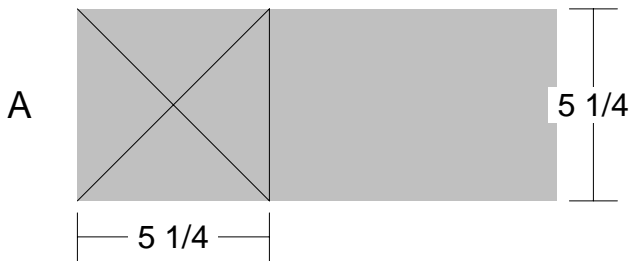

Windmill

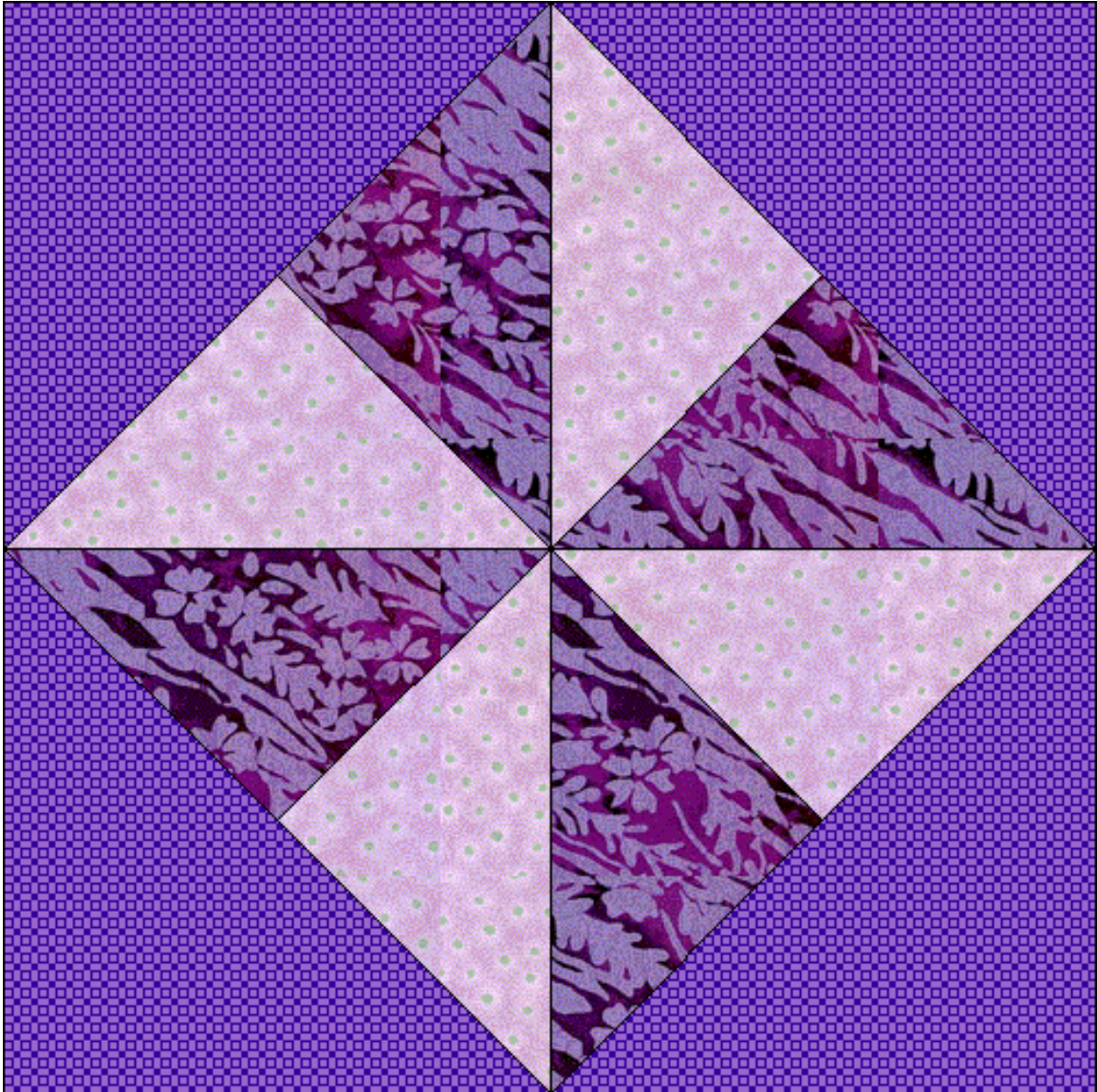

Windmill

Pattern for 8.00x8.00 block
Key Block (2/5 actual size)

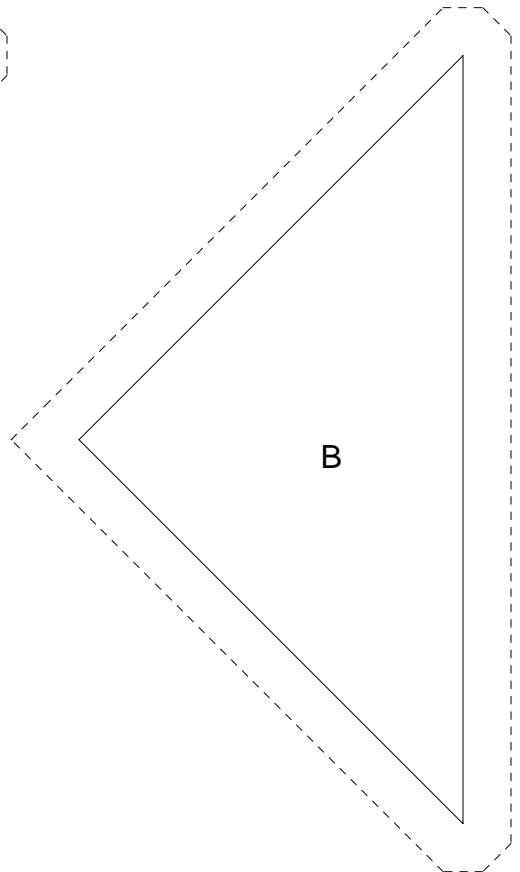
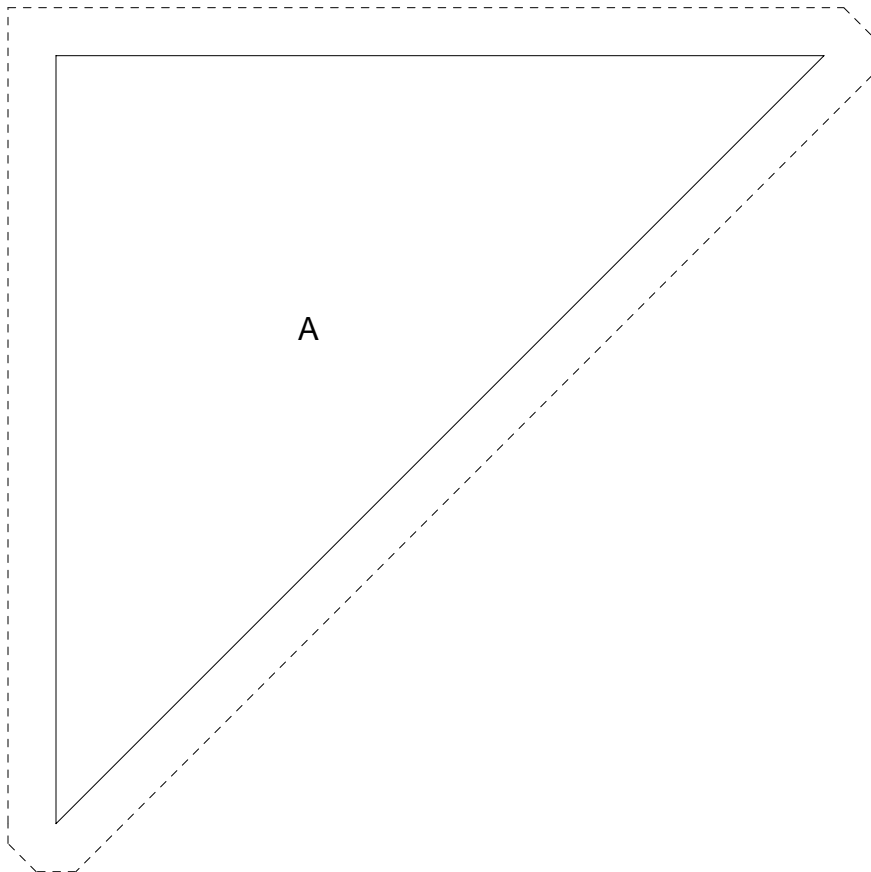
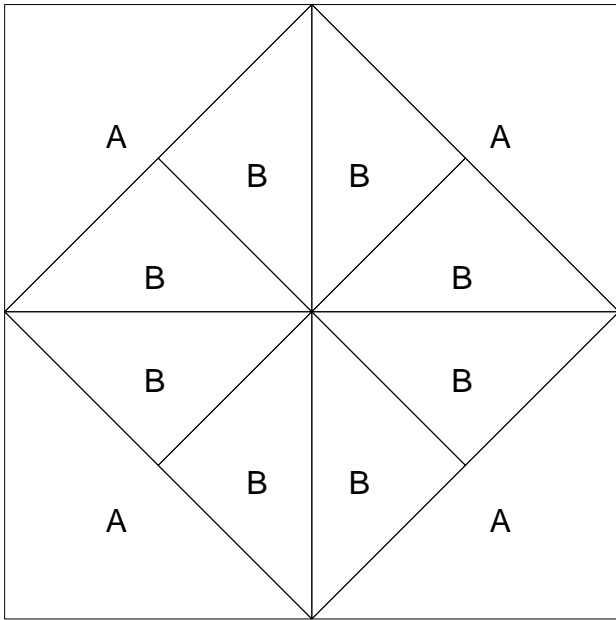

Windmill

Pattern for 8.00x8.00 block
Key Block (31/100 actual size)

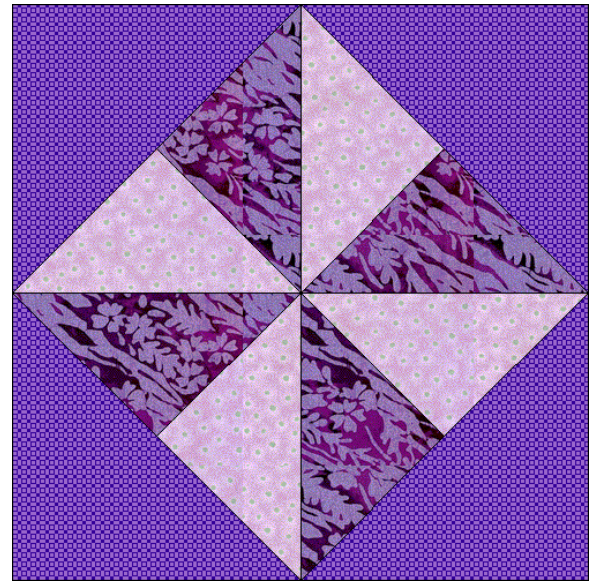
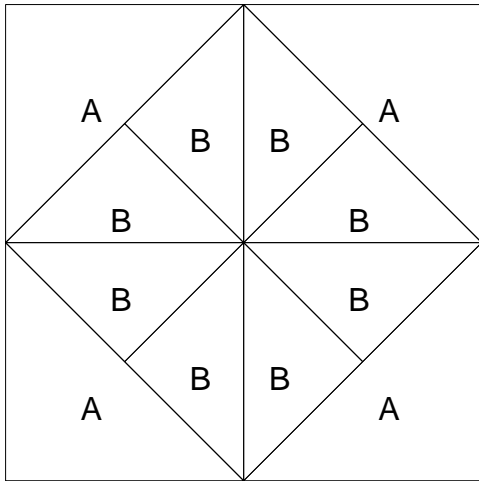

Cutting Diagrams

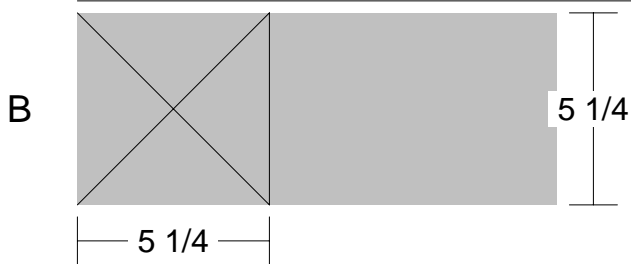
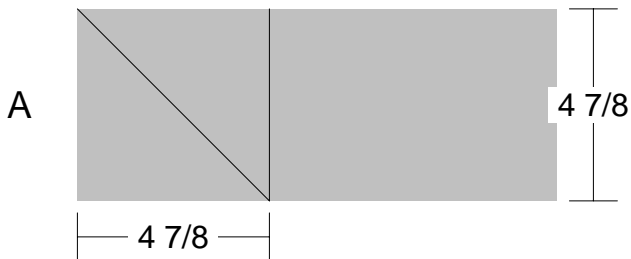

Patch Count

