

Picnic Quilt Block Patterns

June 2007 How-to-Quilt Newsletter

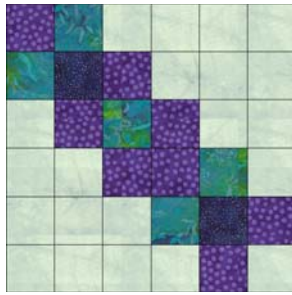

Confetti

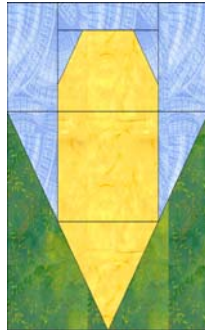

Corn

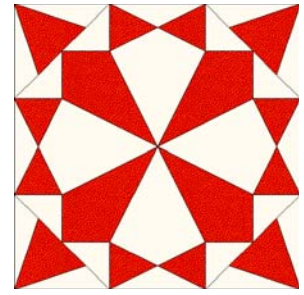

Firecrackers & Skyrockets

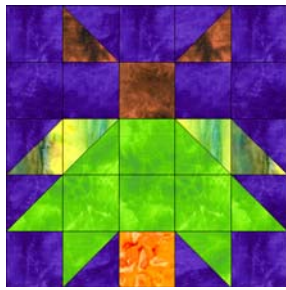

Firefly

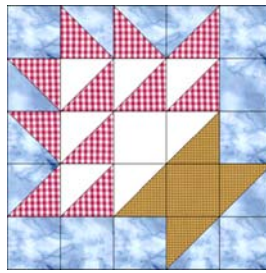

Picnic Basket

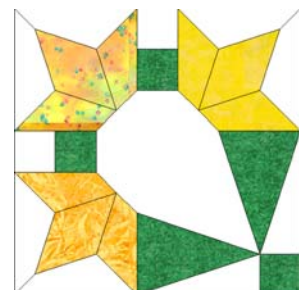

Pineapple

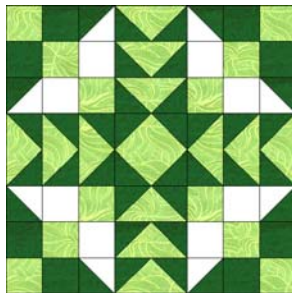

Shady Pine

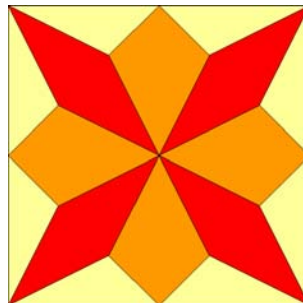

Skyrocket

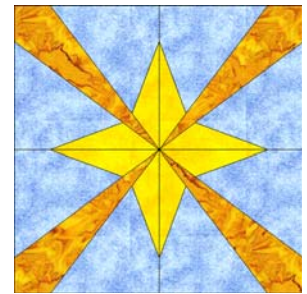

Sunshiny Day

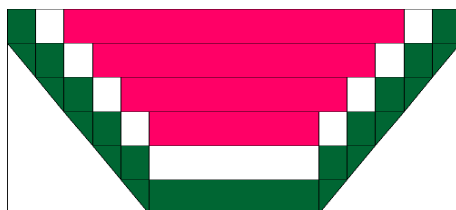

Watermelon

Confetti

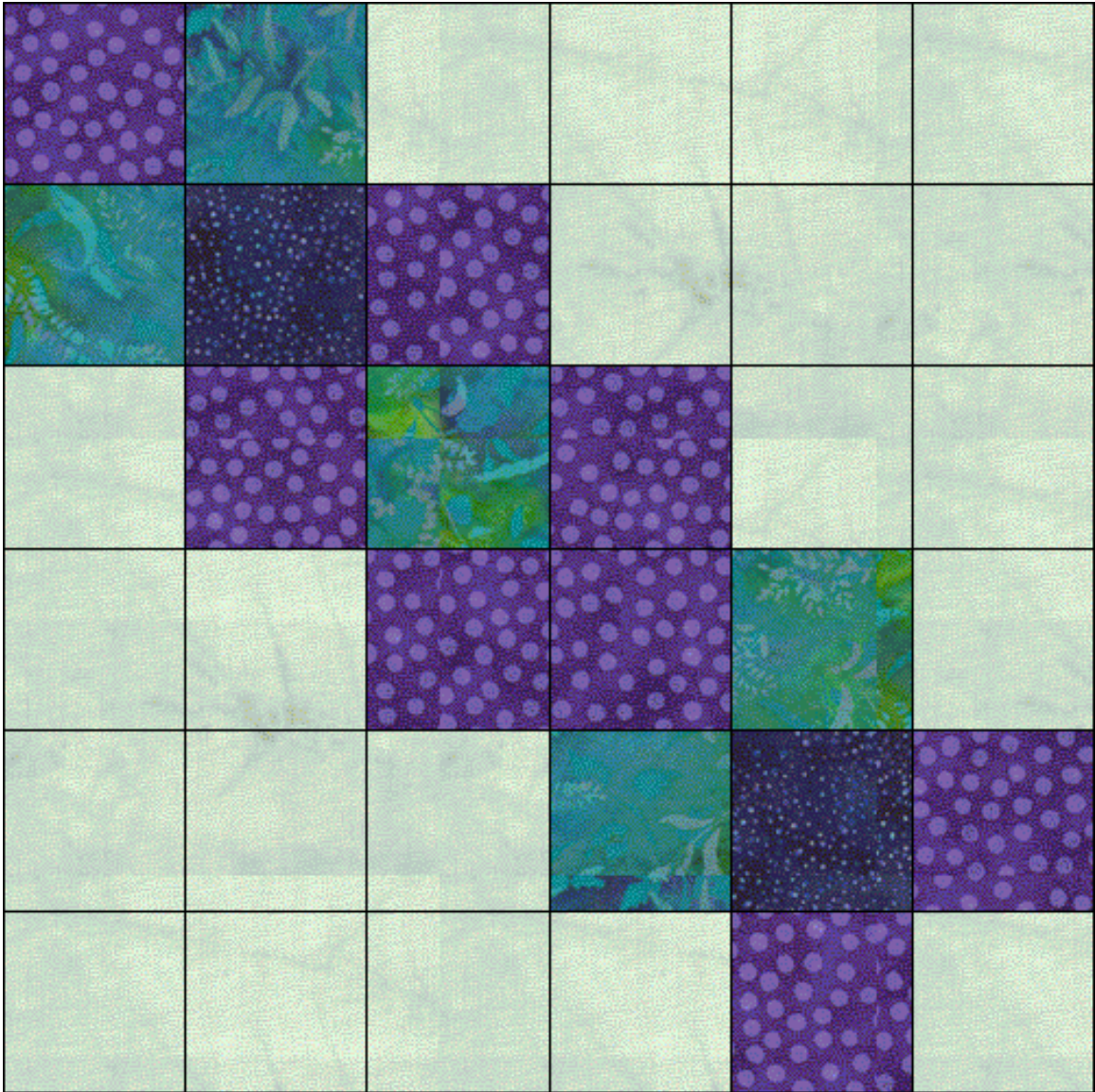

Picnic Quilt Block Patterns

June 2007 How-to-Quilt Newsletter

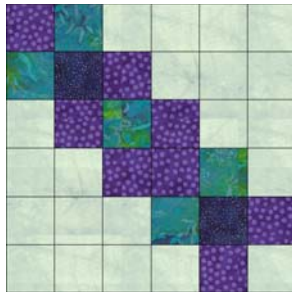

Confetti



Corn

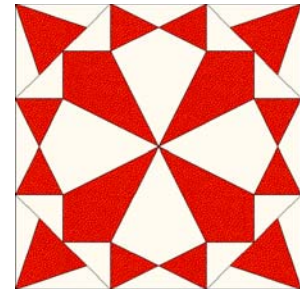

Firecrackers & Skyrockets

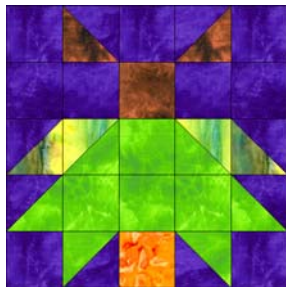

Firefly

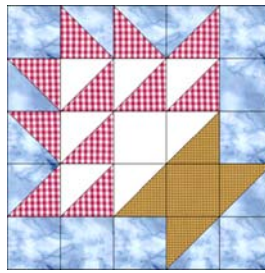

Picnic Basket

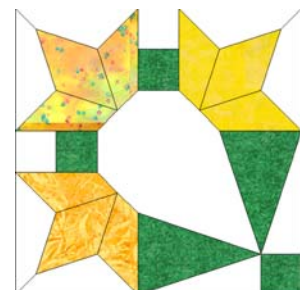

Pineapple

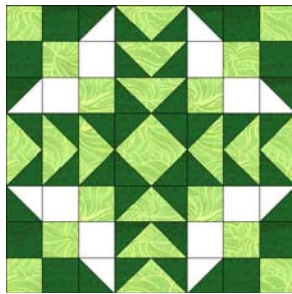

Shady Pine

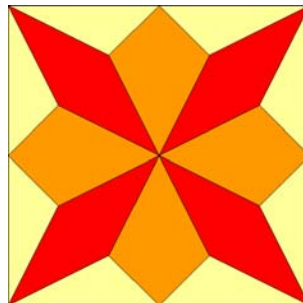

Skyrocket

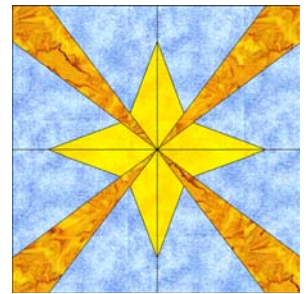

Sunshiny Day

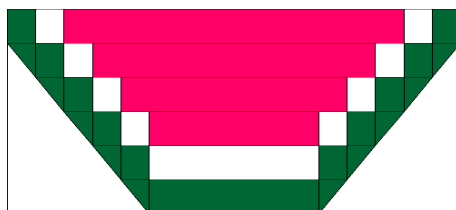

Watermelon

Confetti
Pattern for 12.00x12.00 block
Key Block (29/100 actual size)

A	A	A	A	A	A
A	A	A	A	A	A
A	A	A	A	A	A
A	A	A	A	A	A
A	A	A	A	A	A
A	A	A	A	A	A

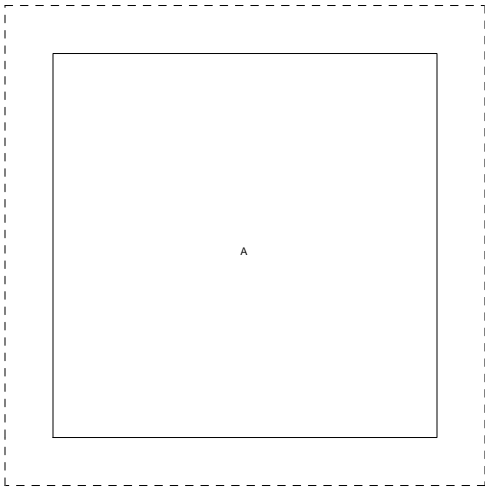

Confetti
 Pattern for 12.00x12.00 block
 Key Block (1/5 actual size)

A	A	A	A	A	A
A	A	A	A	A	A
A	A	A	A	A	A
A	A	A	A	A	A
A	A	A	A	A	A
A	A	A	A	A	A

Cutting Diagrams



Patch Count

Corn

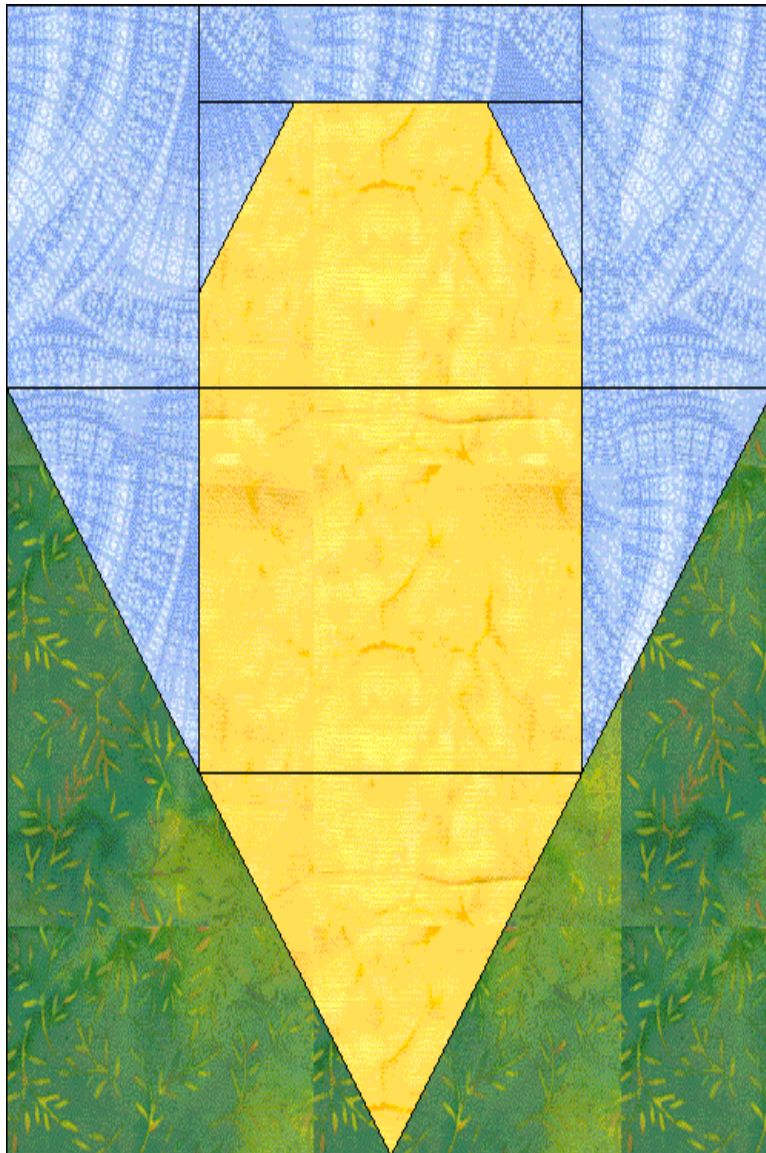

Corn
 Pattern for 4.00x6.00 block
 Key Block (29/50 actual size)

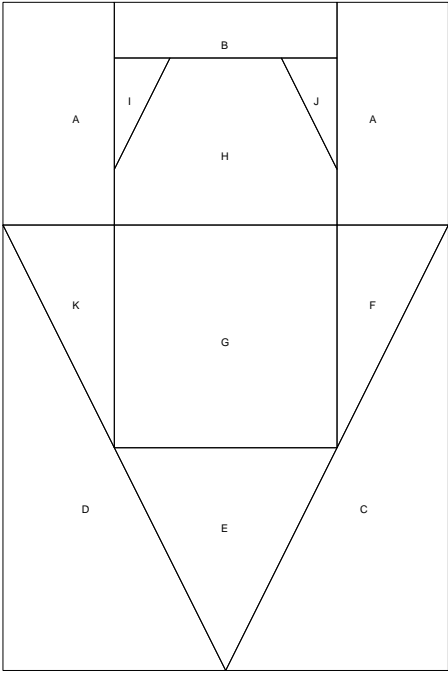

Cutting Diagrams

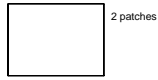
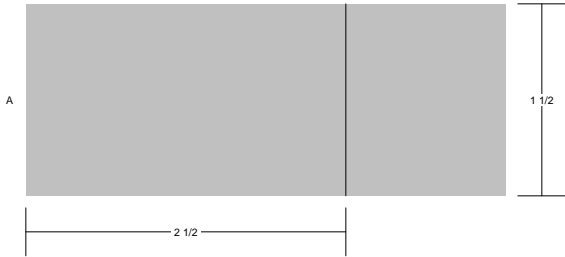

Patch Count

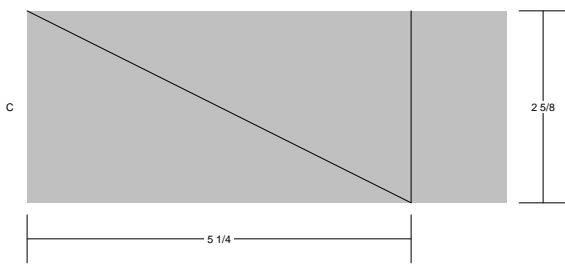

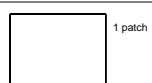
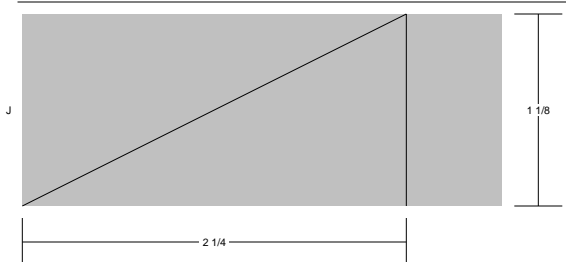
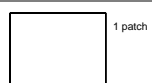
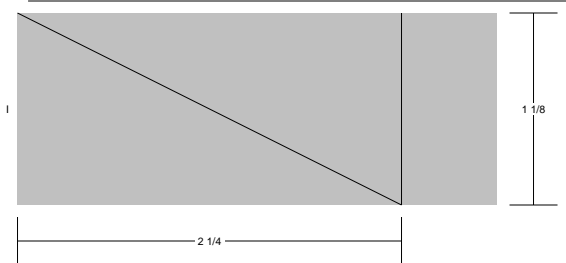
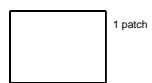
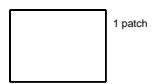
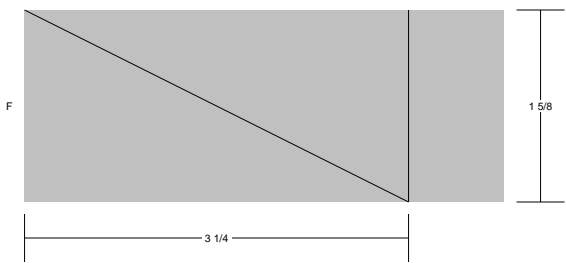
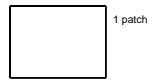
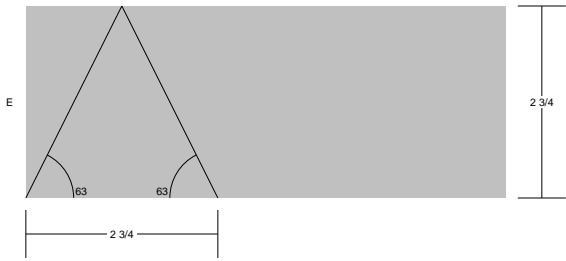
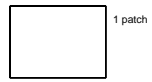
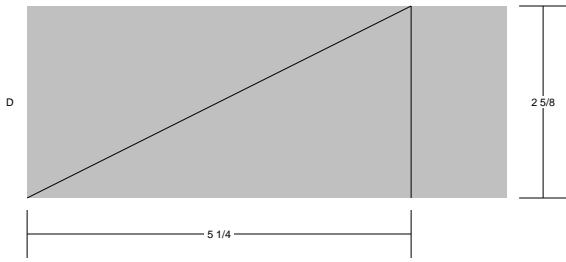

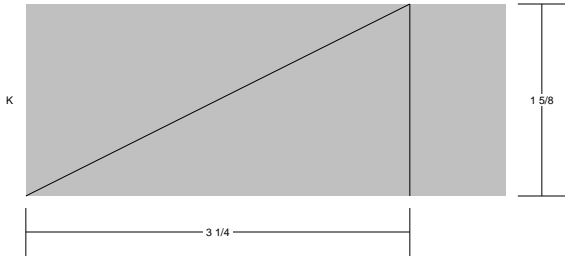

Corn
Pattern for 4.00x6.00 block
Key Block (4/5 actual size)

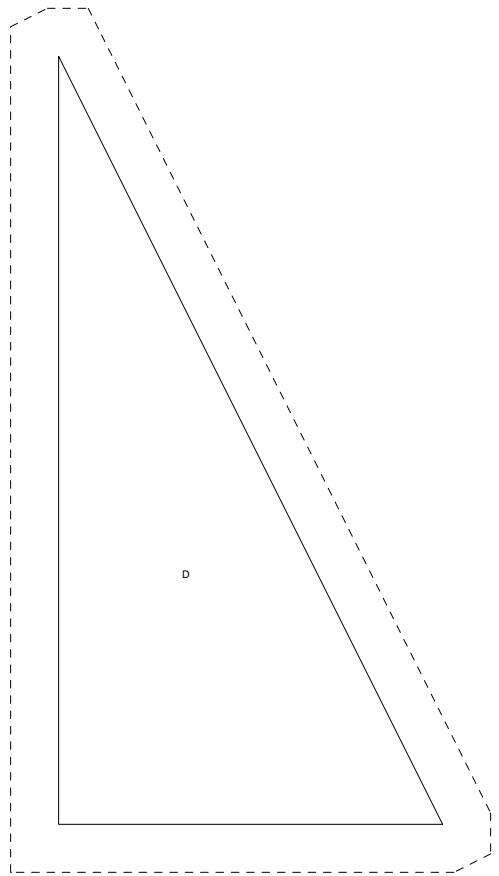
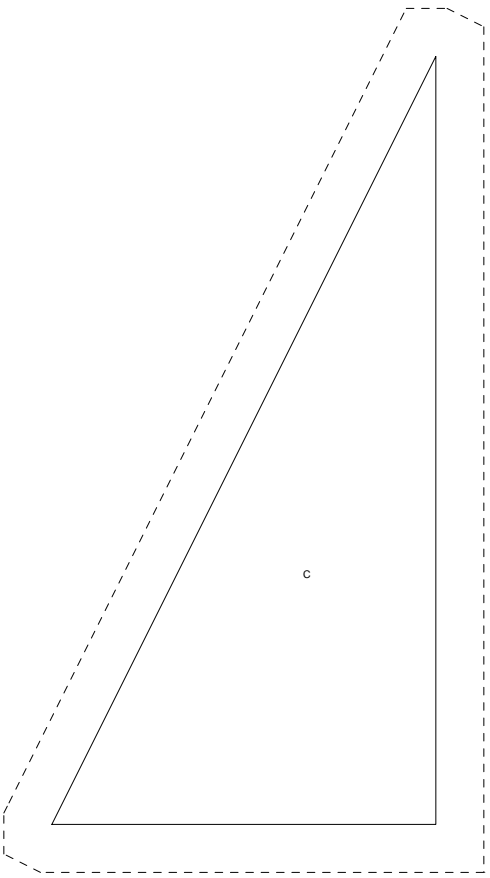
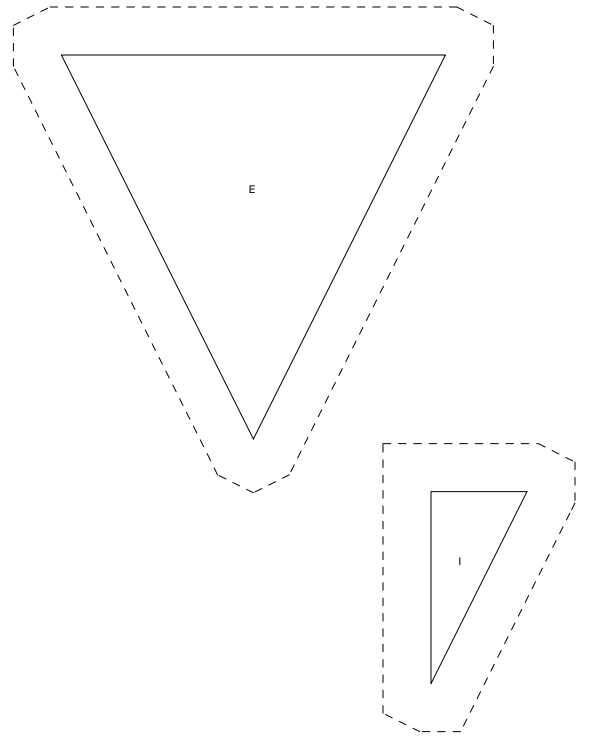
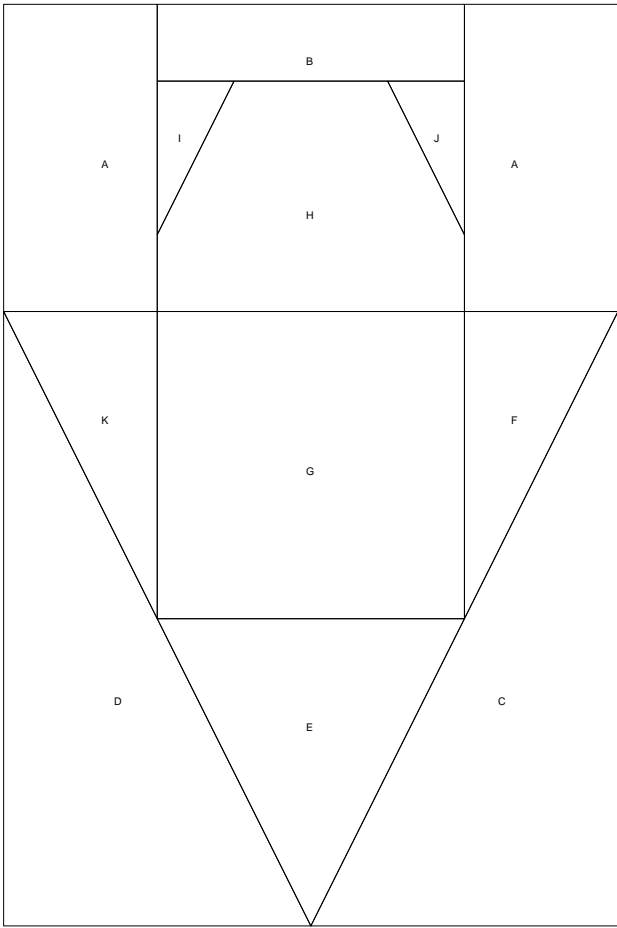

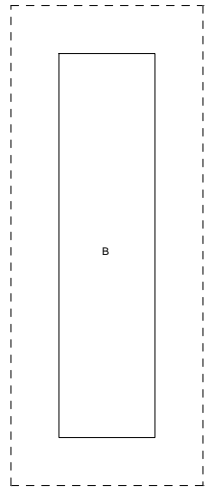
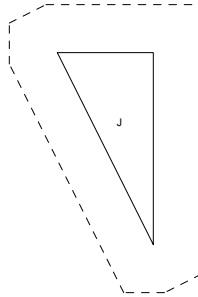
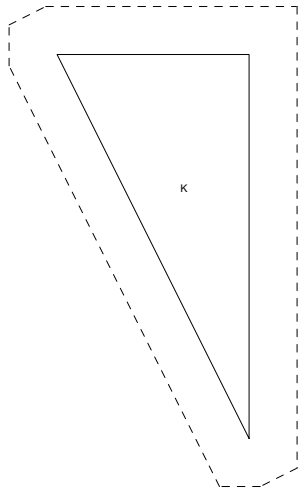
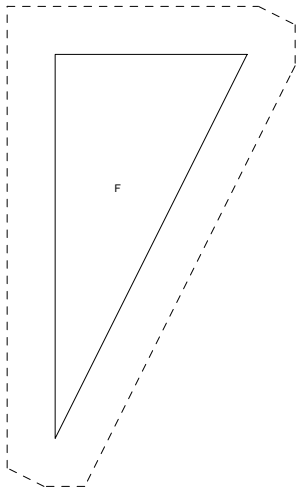
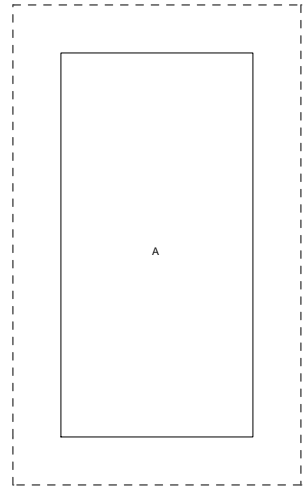
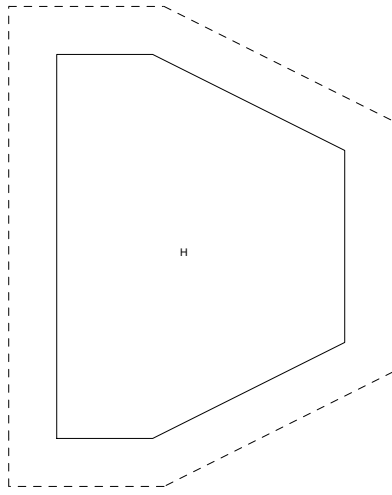
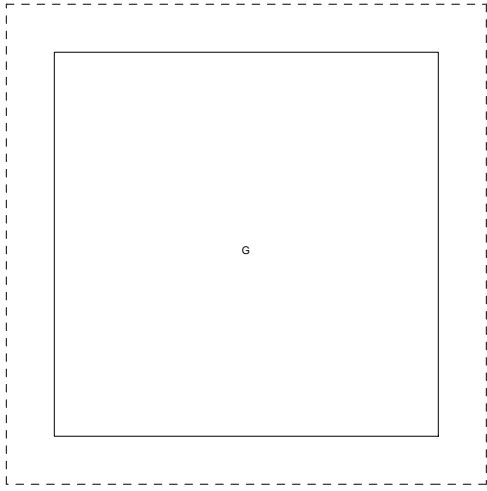

Corn

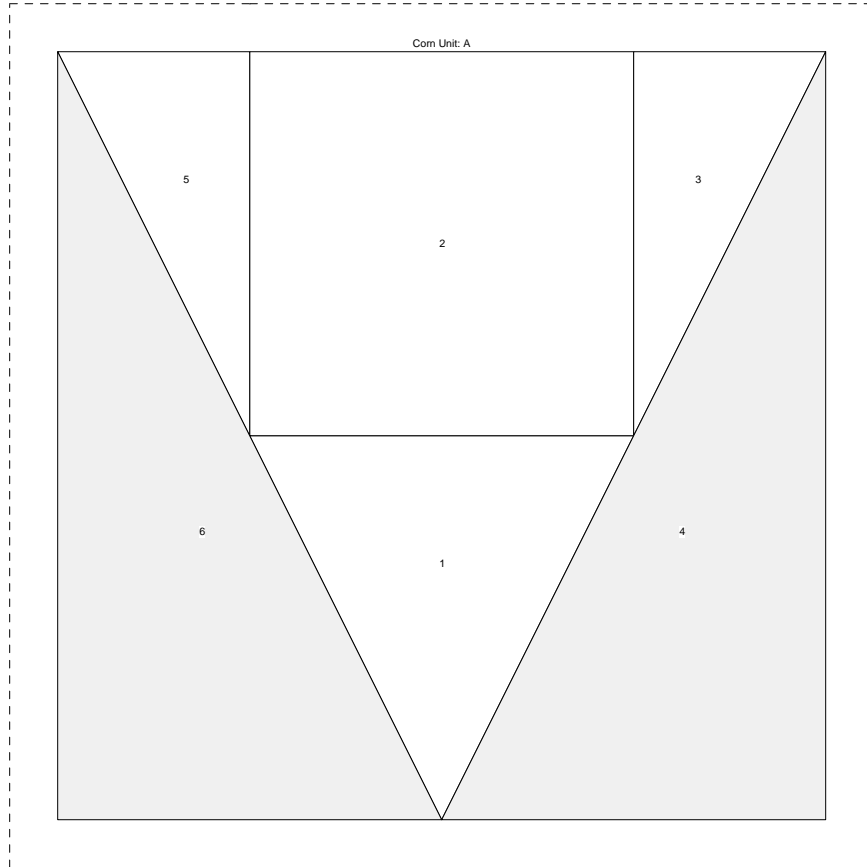
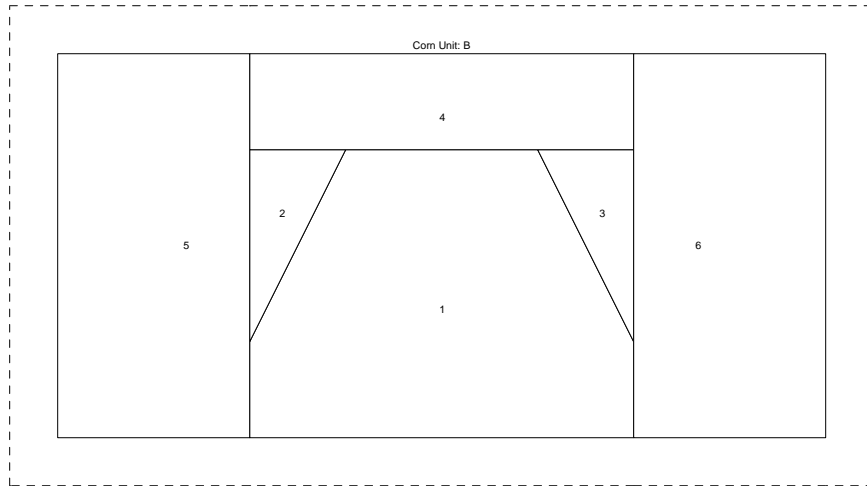

Firecrackers & Skyrockets

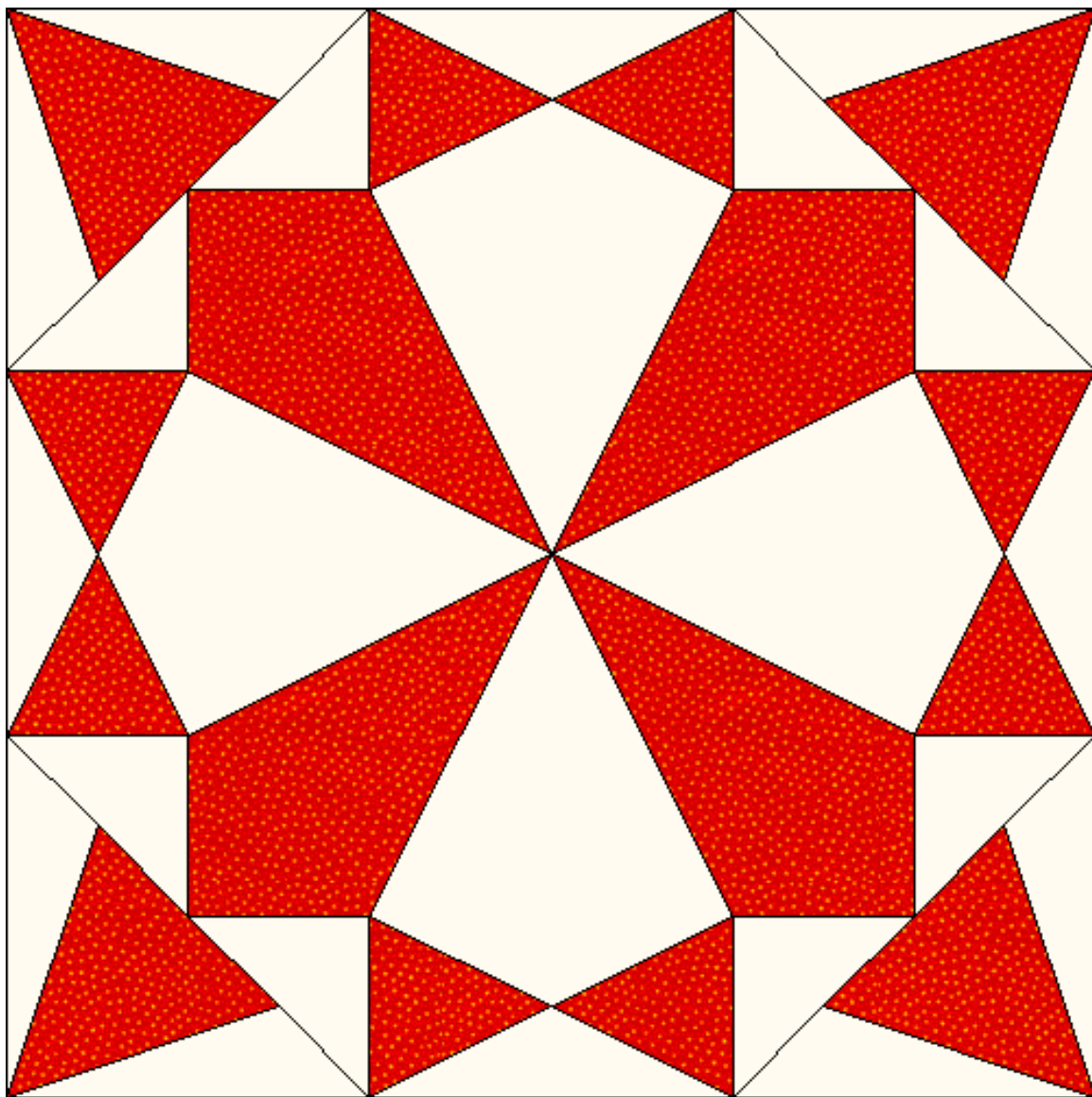

Firecrackers & Skyrockets

Pattern for 12.00x12.00 block
Key Block (29/100 actual size)

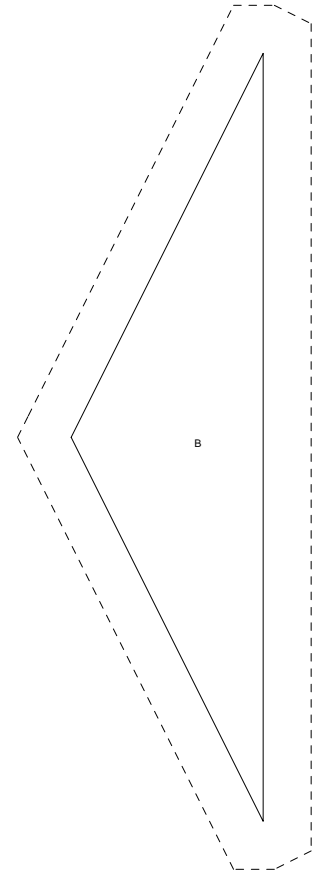
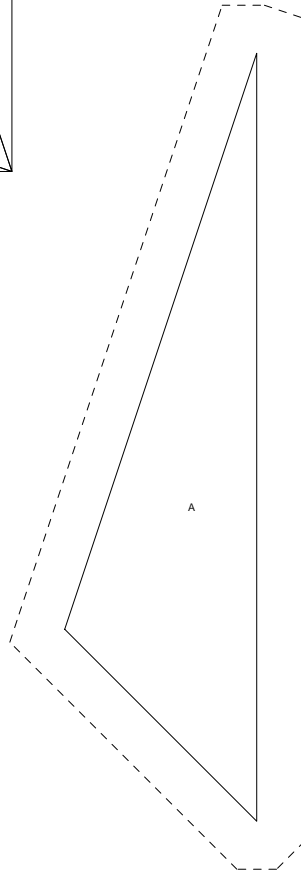
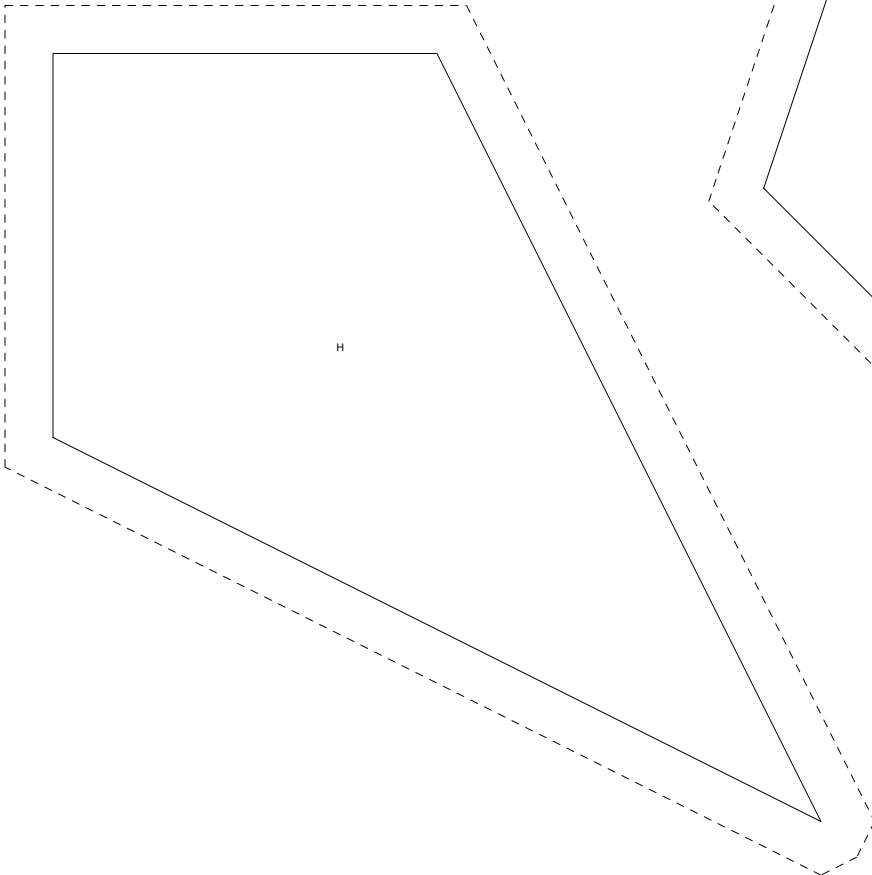
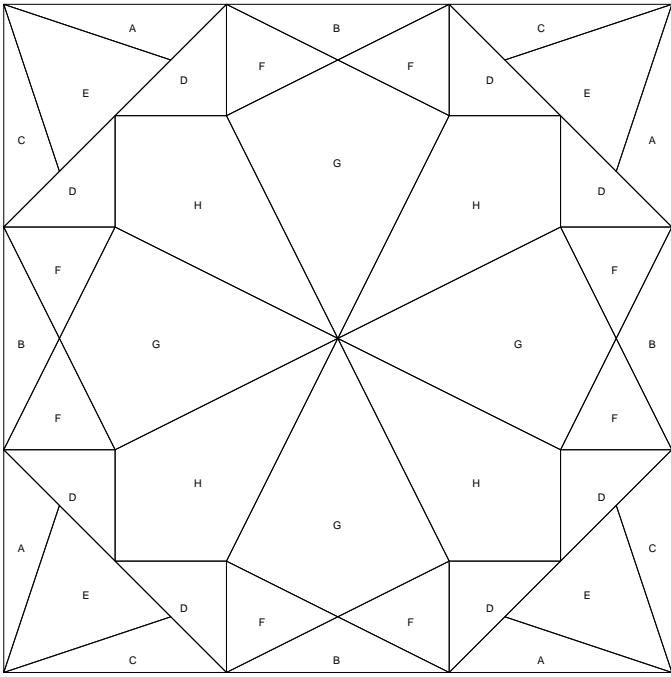

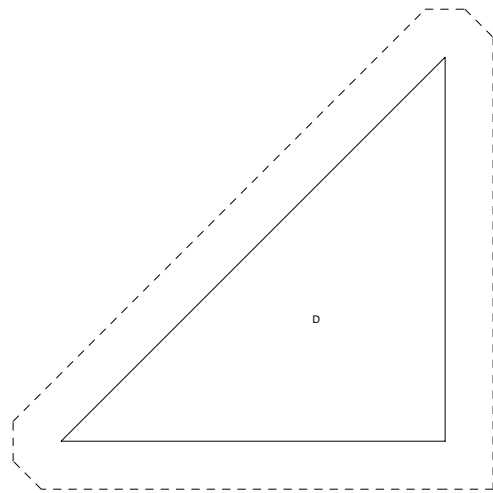
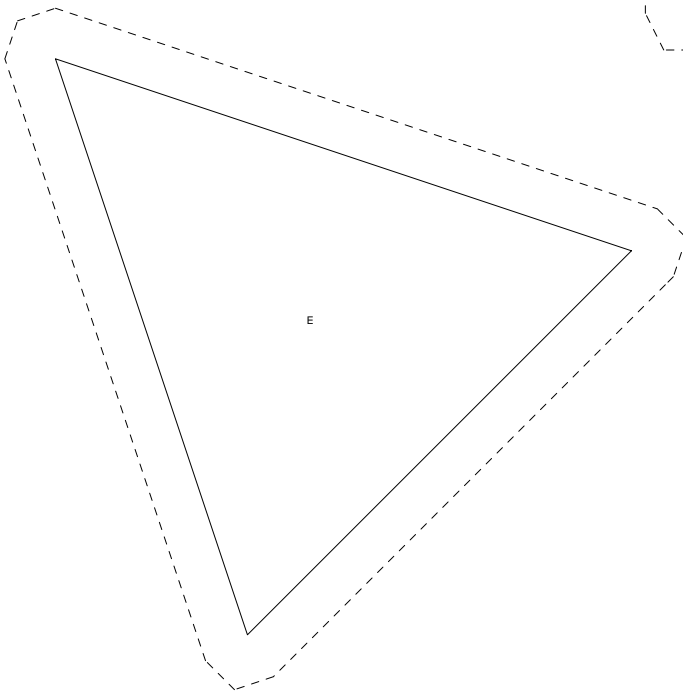
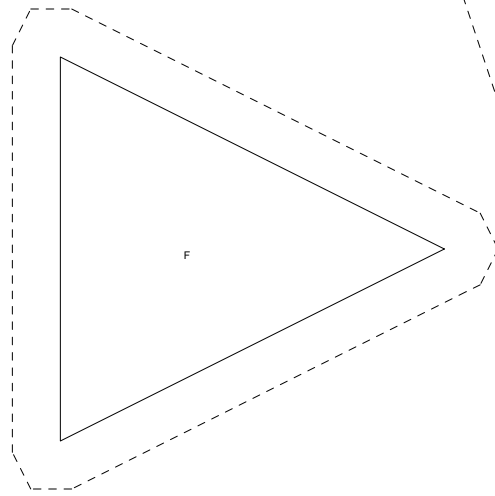
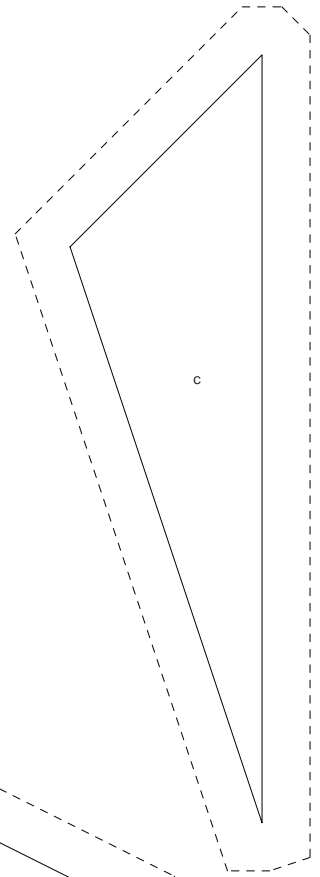
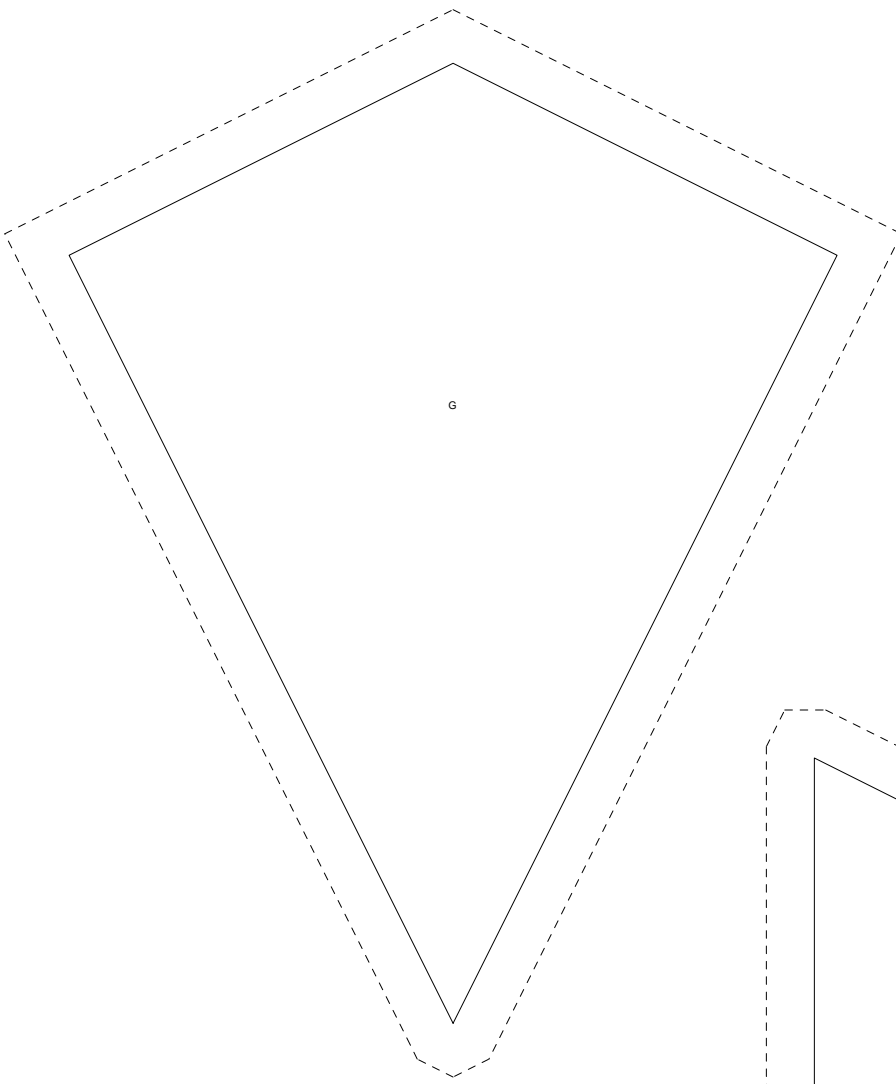

Firecrackers & Skyrockets

Pattern for 12.00x12.00 block
Key Block (1/5 actual size)

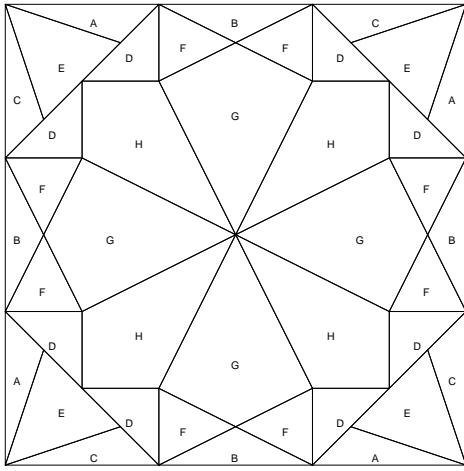

Cutting Diagrams

Patch Count

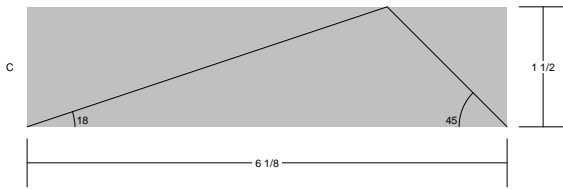
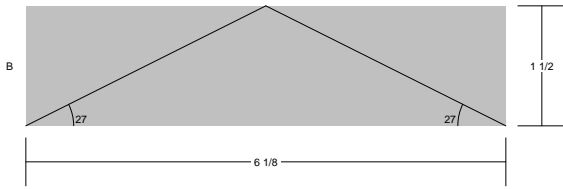
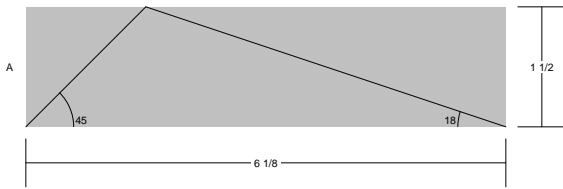

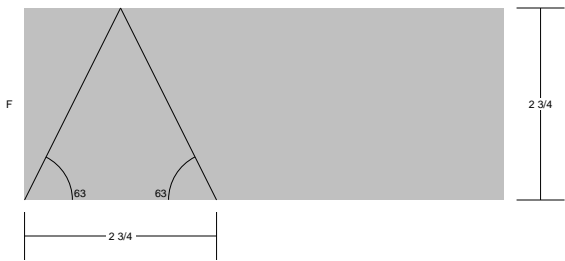
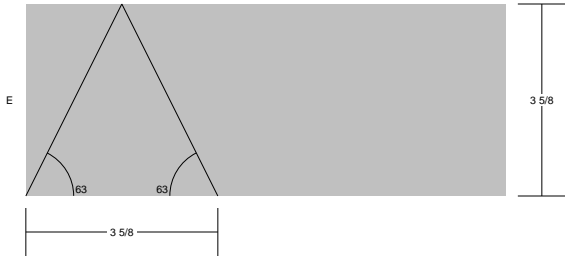
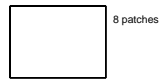
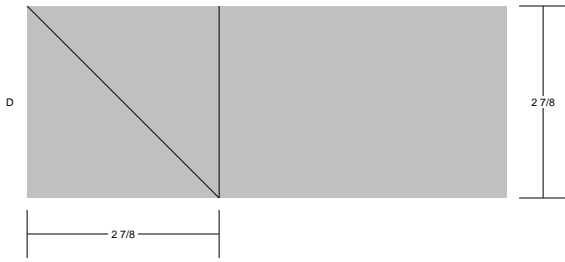

Firecrackers & Skyrockets

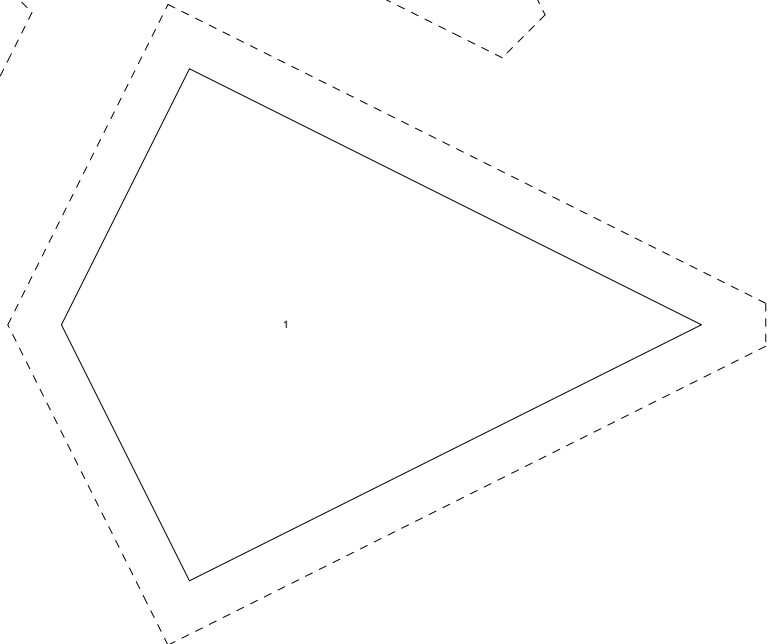
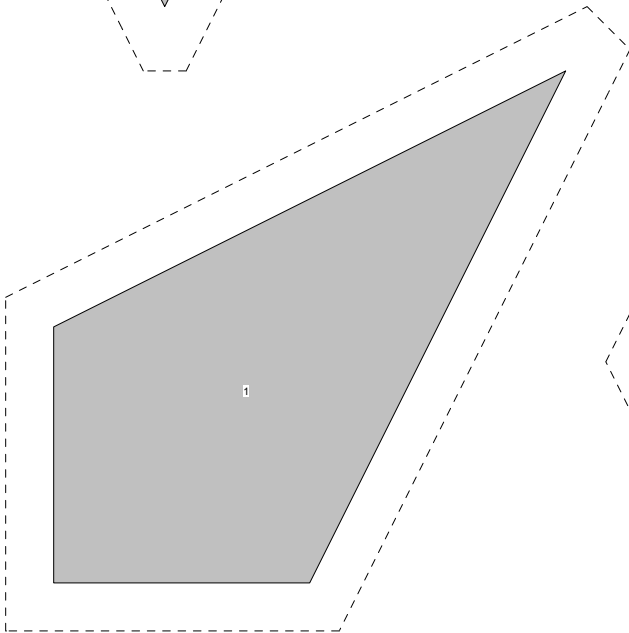
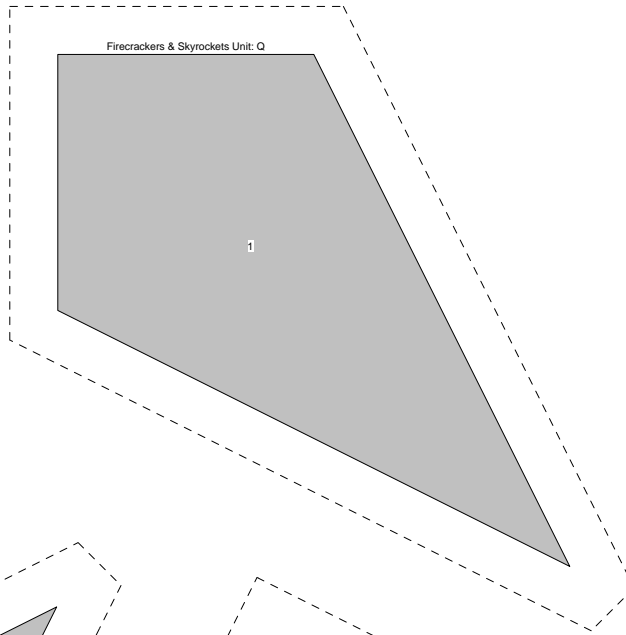
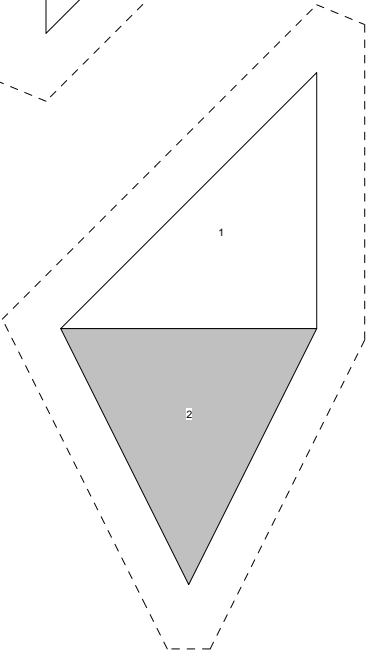
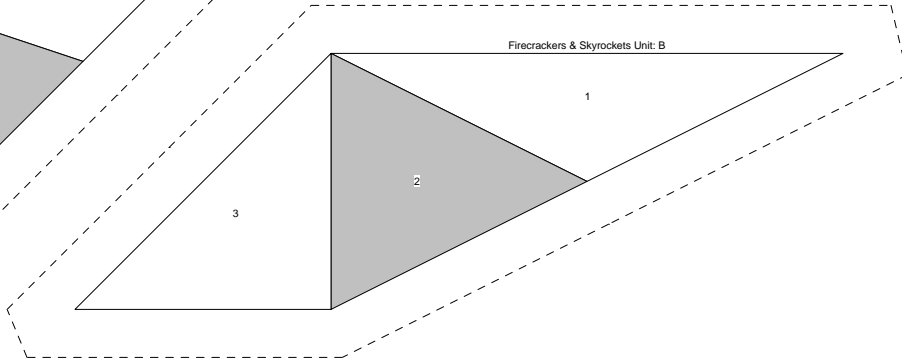
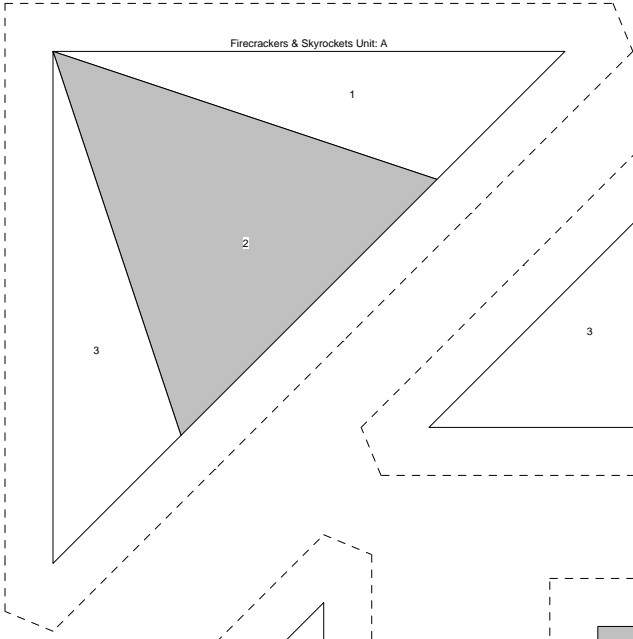

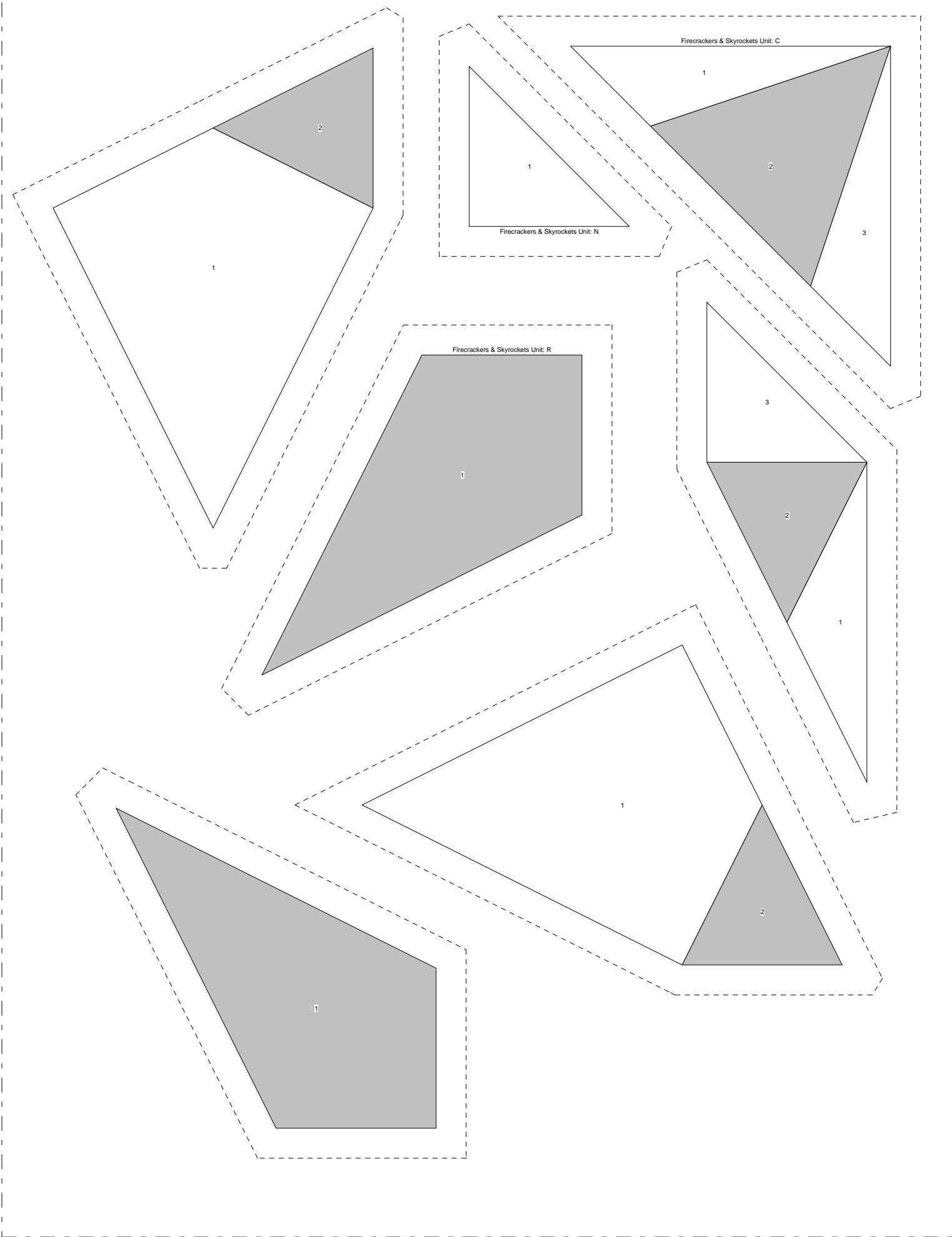

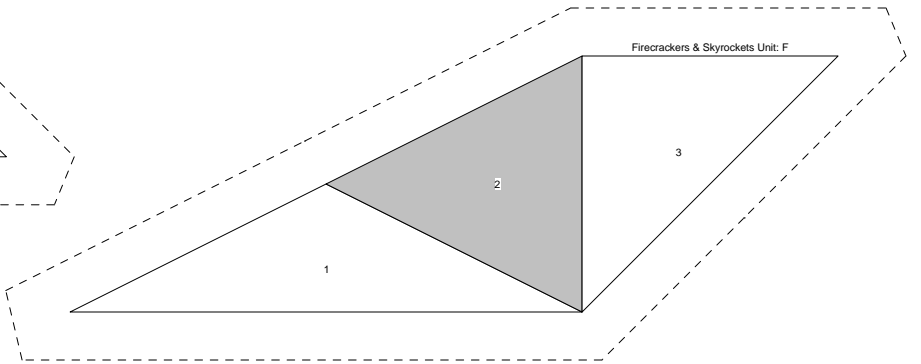
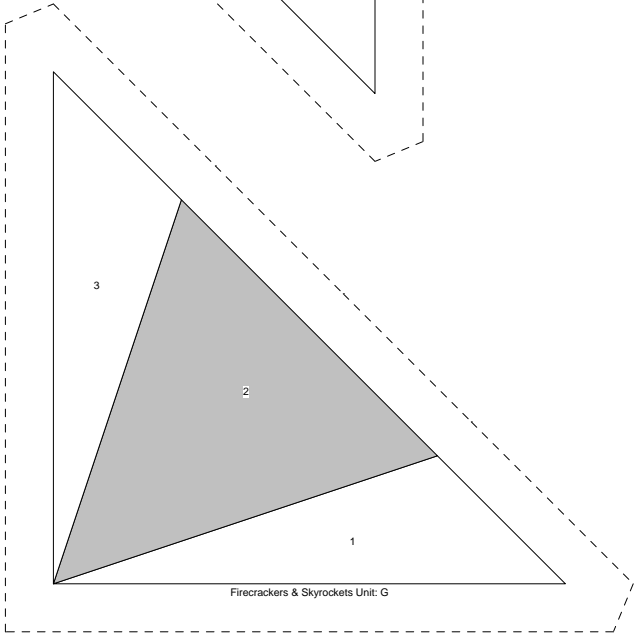
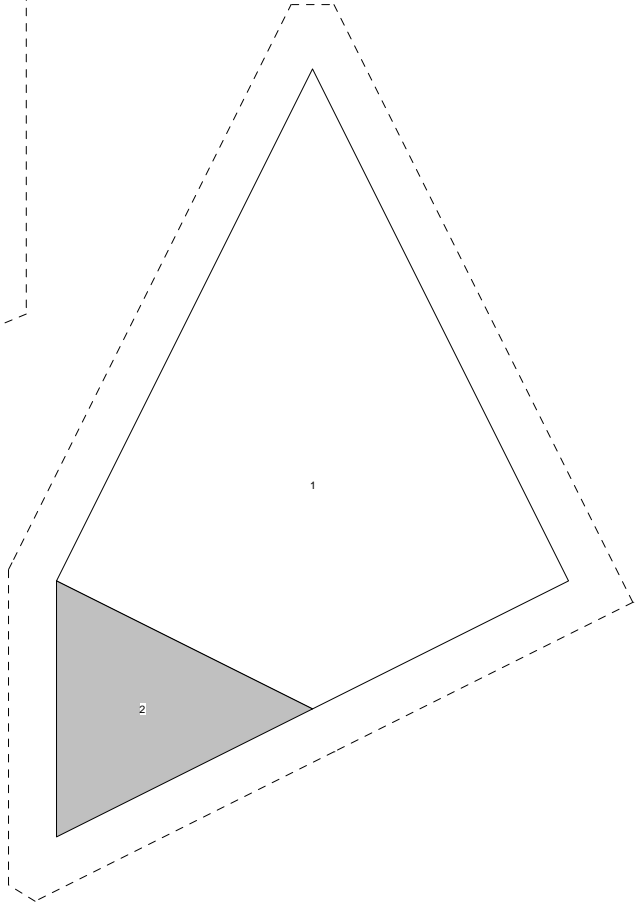
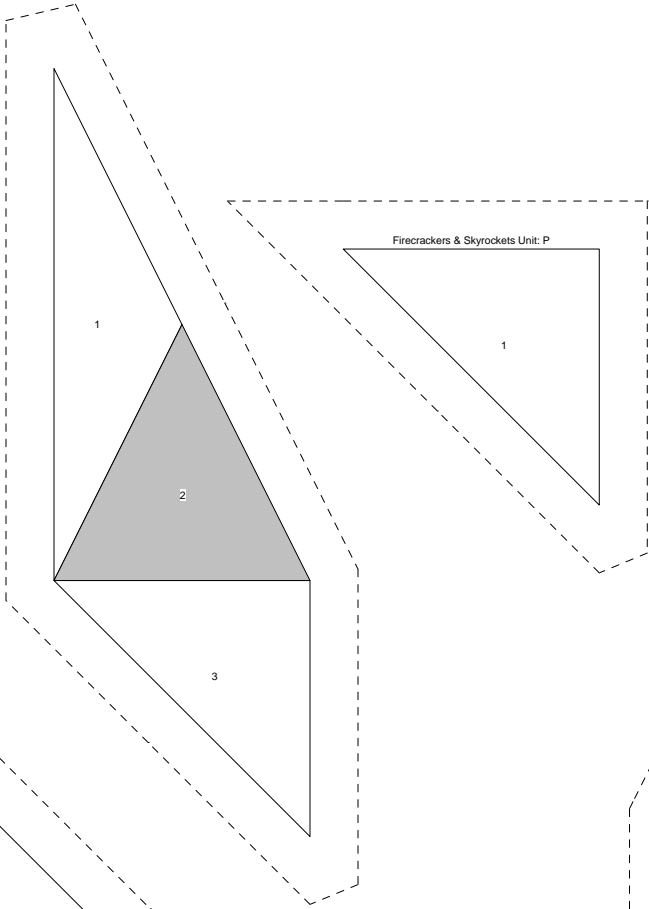

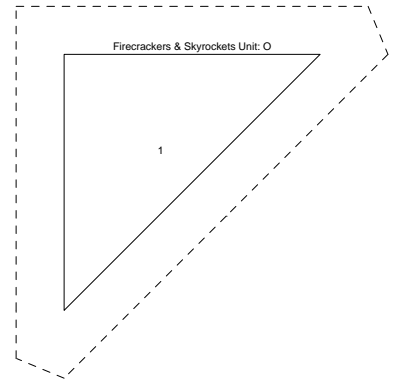
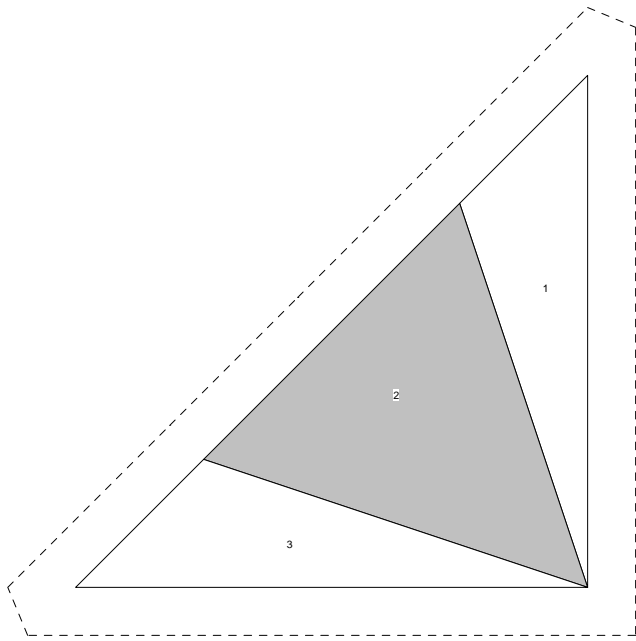

Firefly

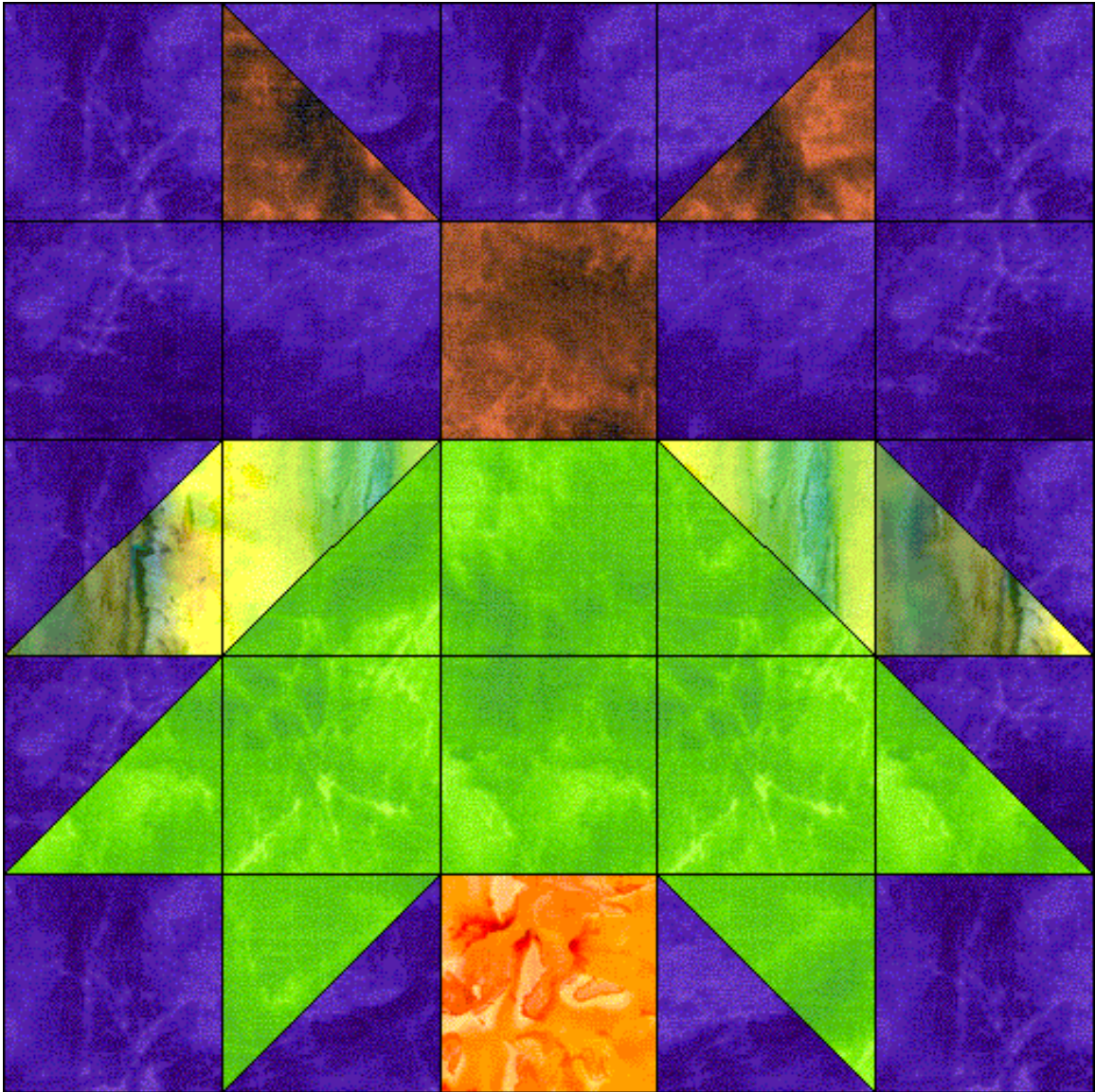

Firefly
 Pattern for 10.00x10.00 block
 Key Block (5/20 actual size)

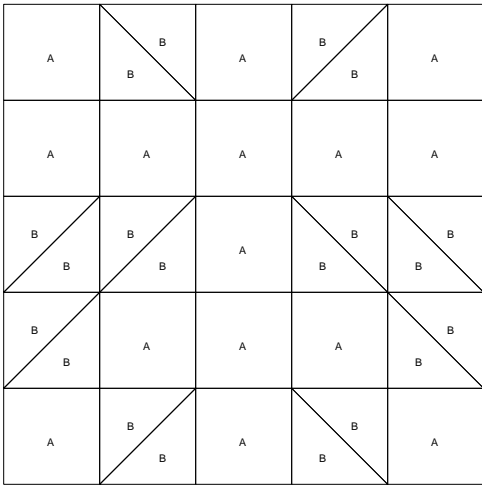

Cutting Diagrams



Patch Count

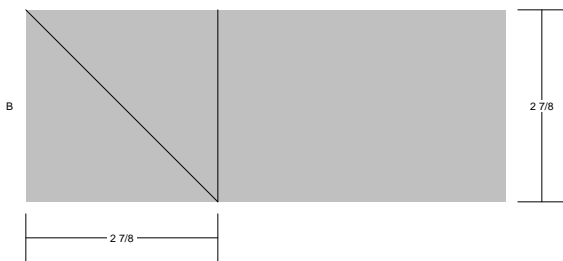

Firefly
Pattern for 10.00x10.00 block
Key Block (17/50 actual size)

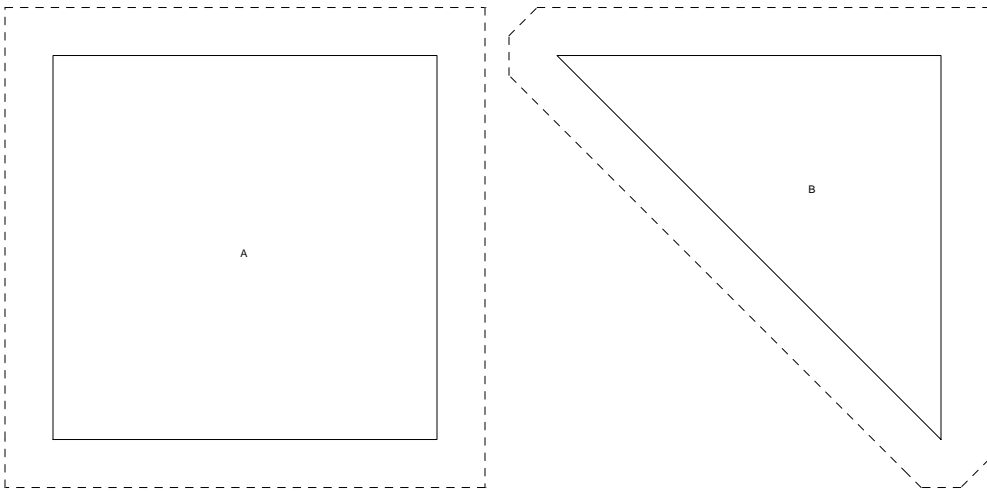
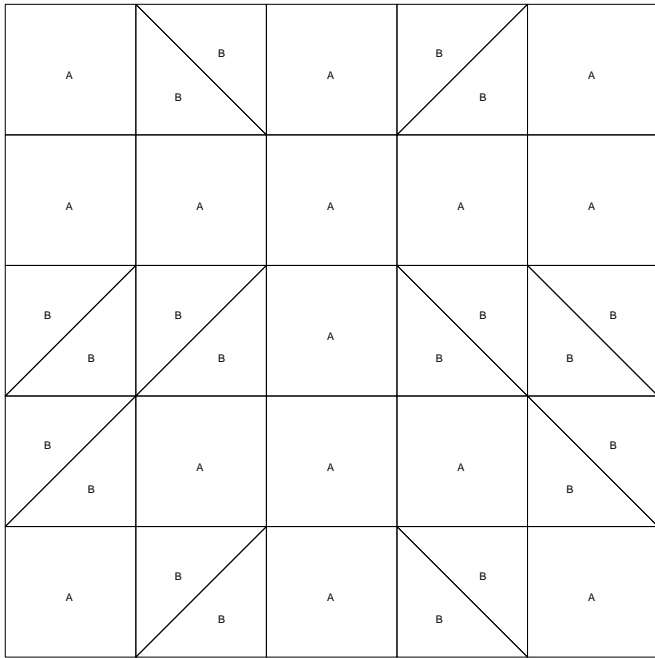

Picnic Basket

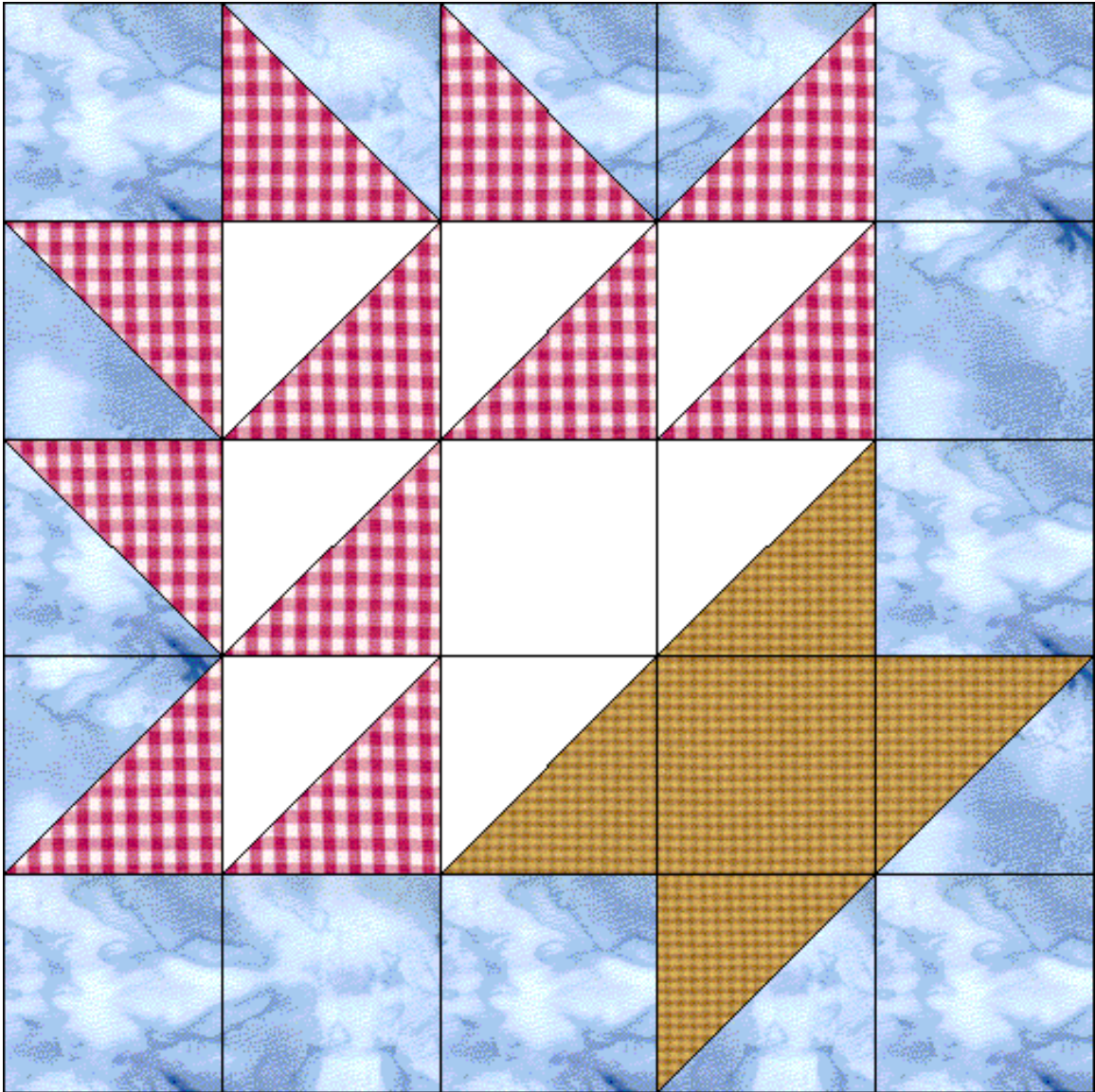

Picnic Basket
 Pattern for 8.00x8.00 block
 Key Block (31/100 actual size)

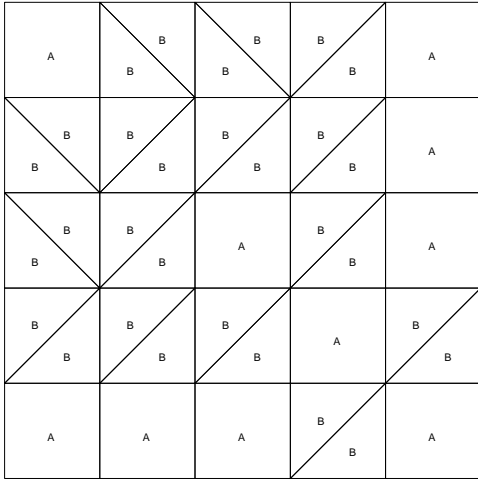

Cutting Diagrams



Patch Count

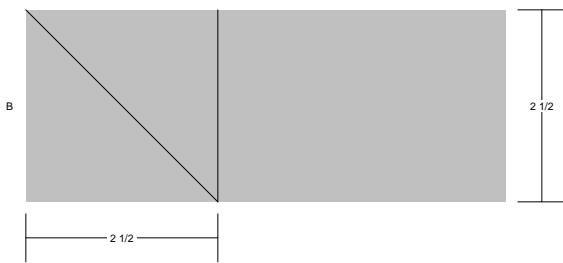

Picnic Basket
Pattern for 8.00x8.00 block
Key Block (43/100 actual size)

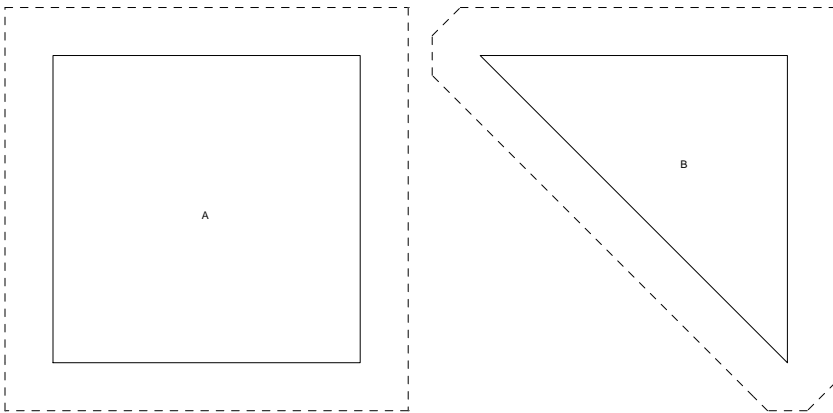
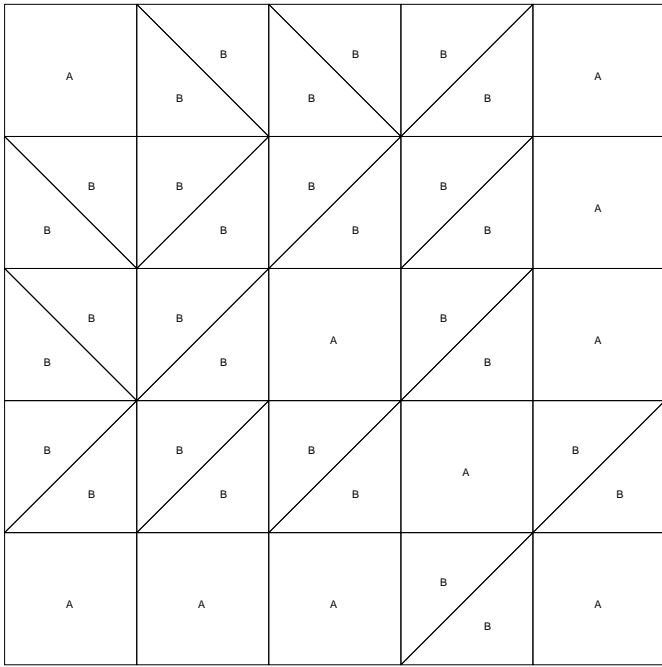

Pineapple

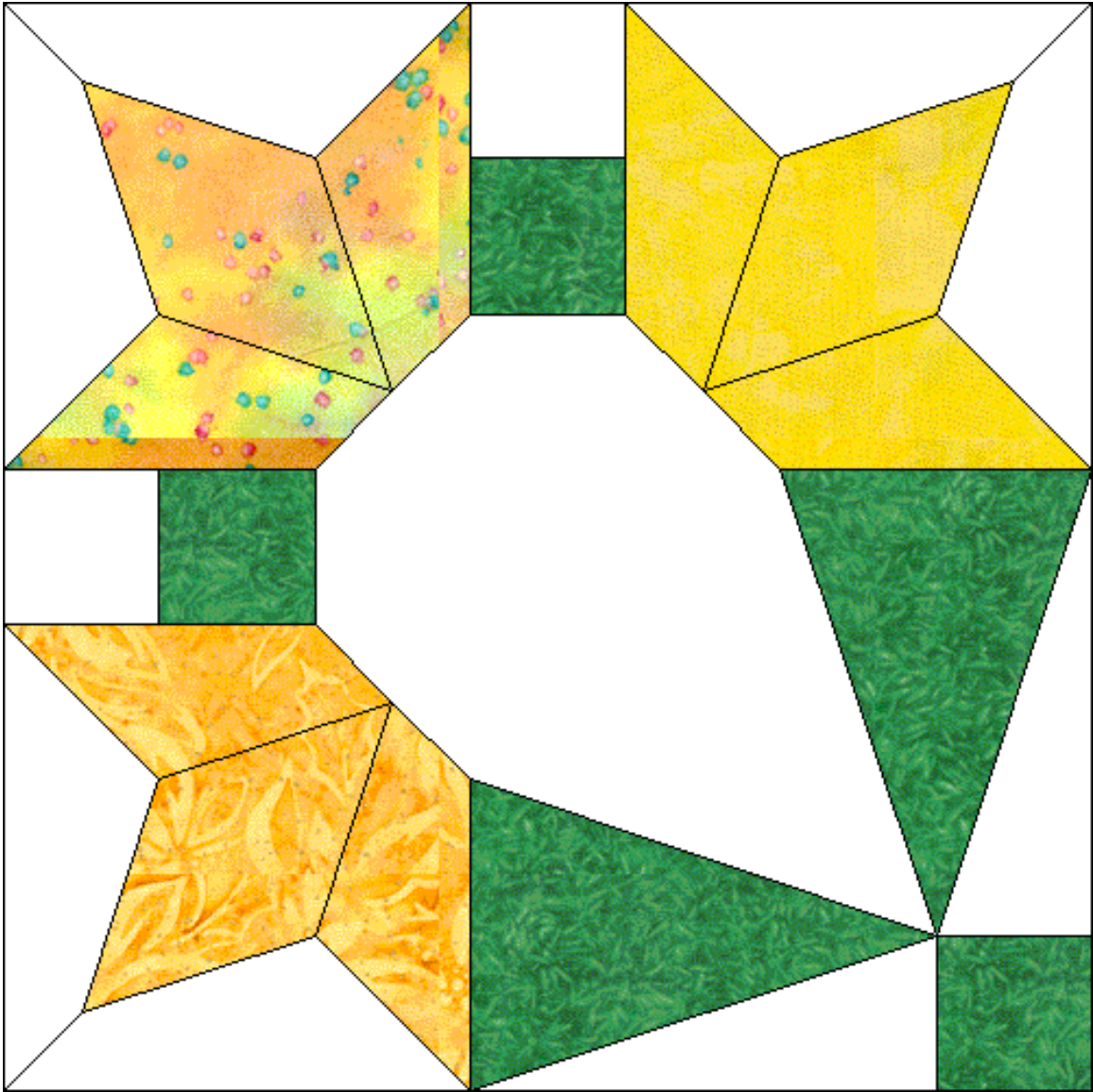

Pineapple
Pattern for 7.00x7.00 block
Key Block (49/100 actual size)

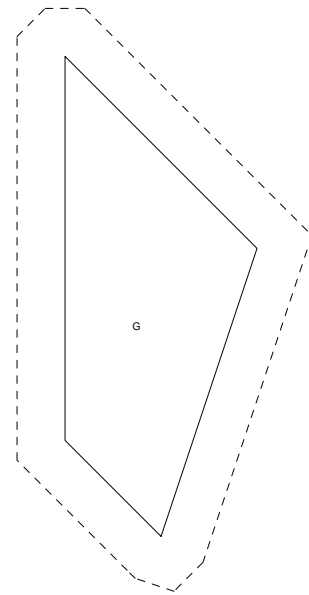
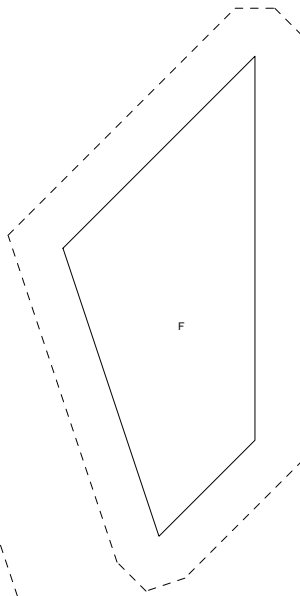
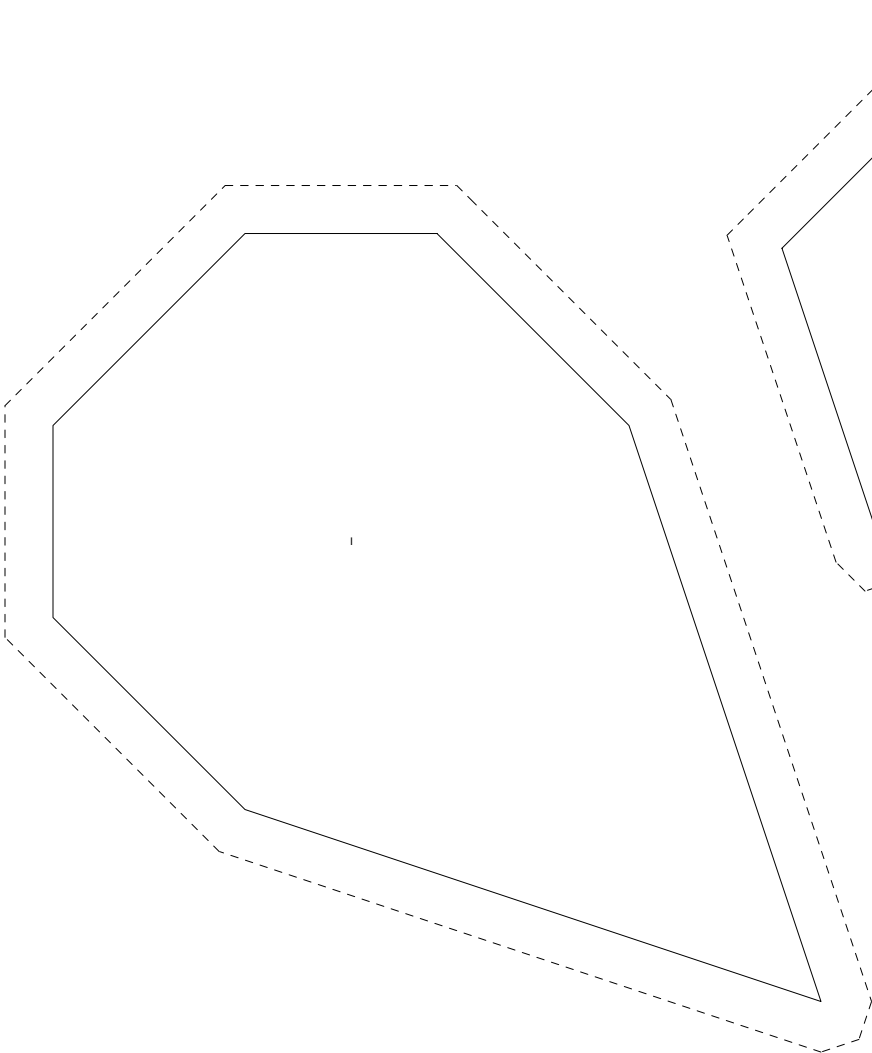
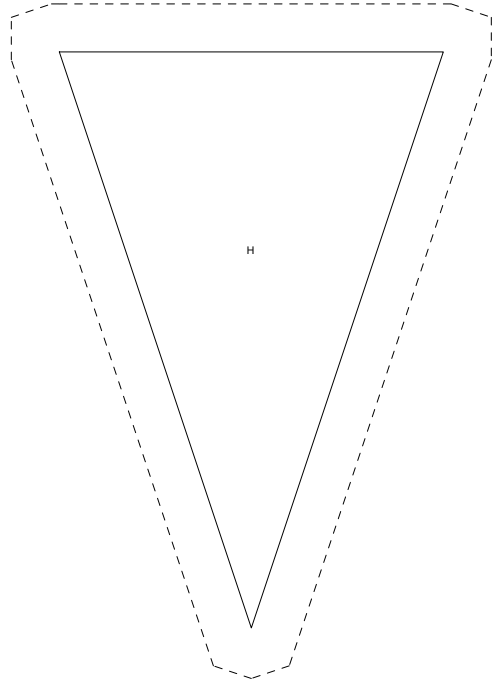
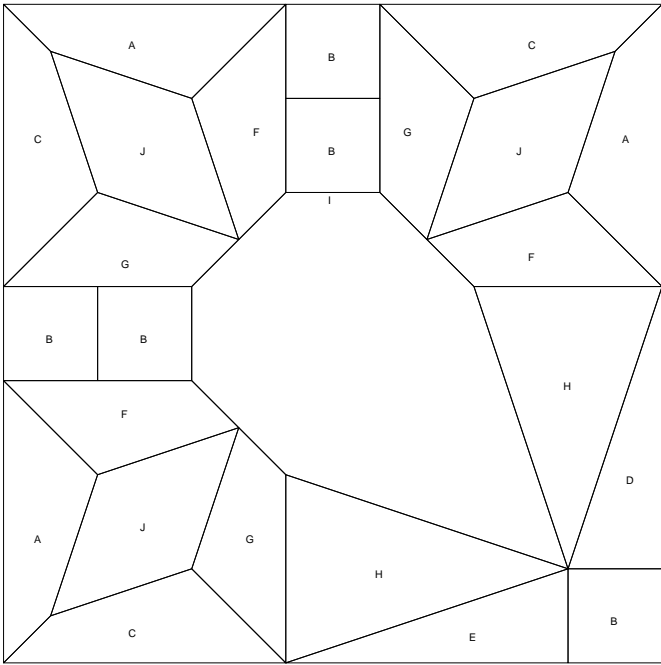

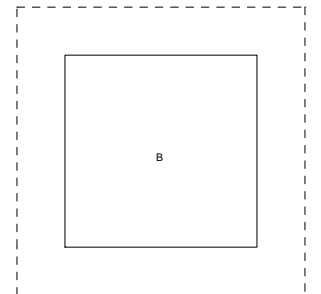
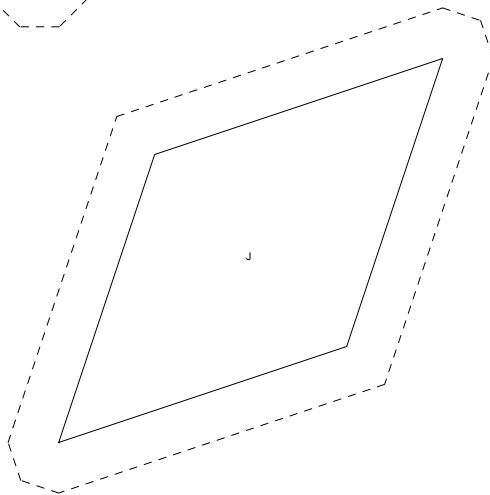
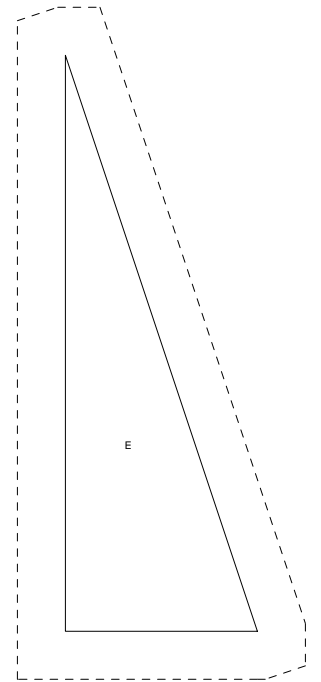
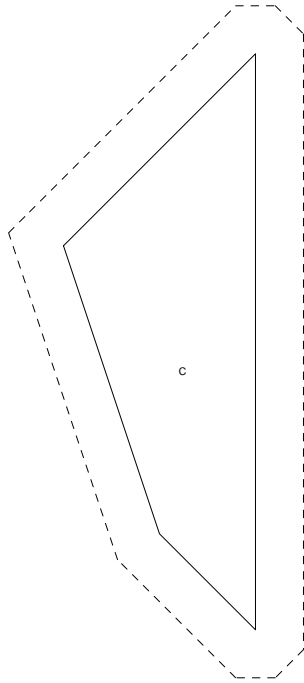
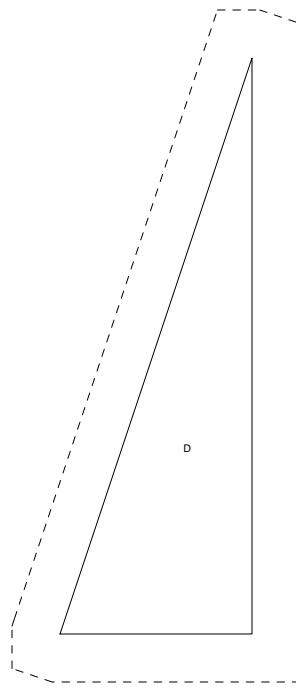
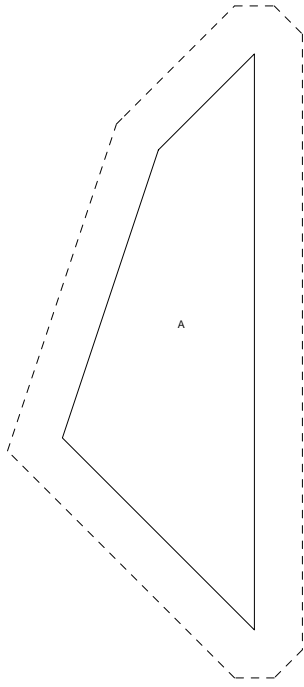

Pineapple
 Pattern for 7.00x7.00 block
 Key Block (7/20 actual size)

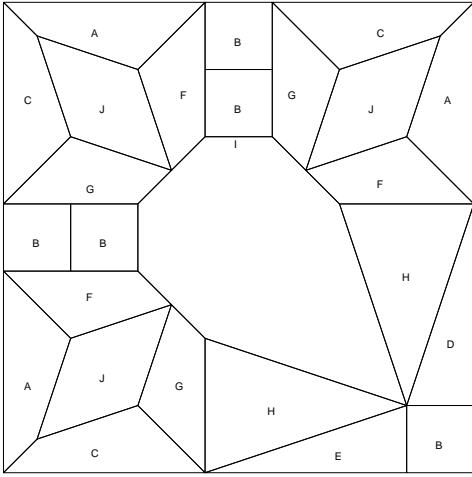

Cutting Diagrams



Patch Count

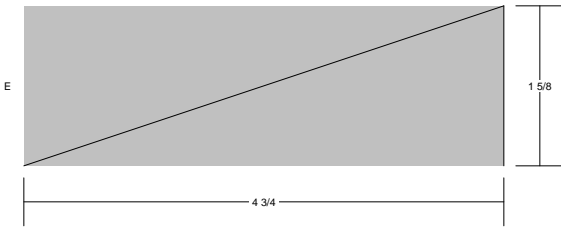
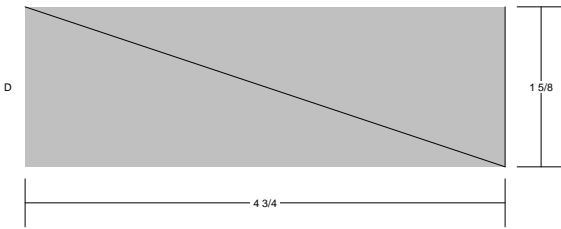

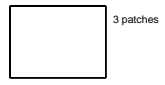
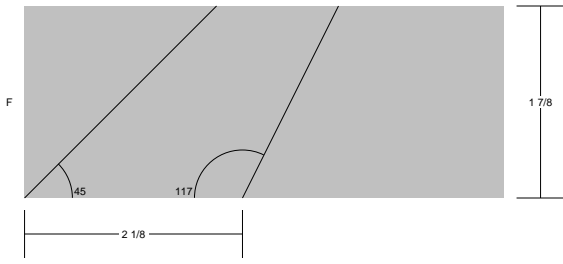

3 patches

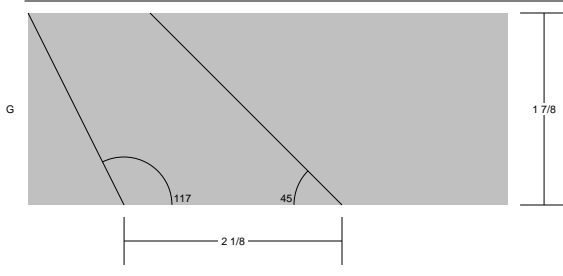

3 patches

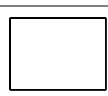
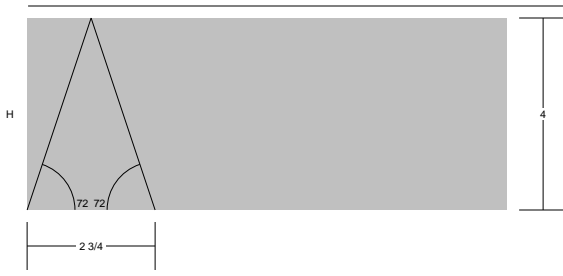

2 patches

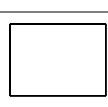
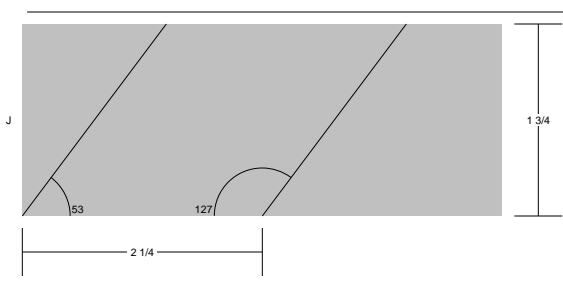

3 patches

Pineapple

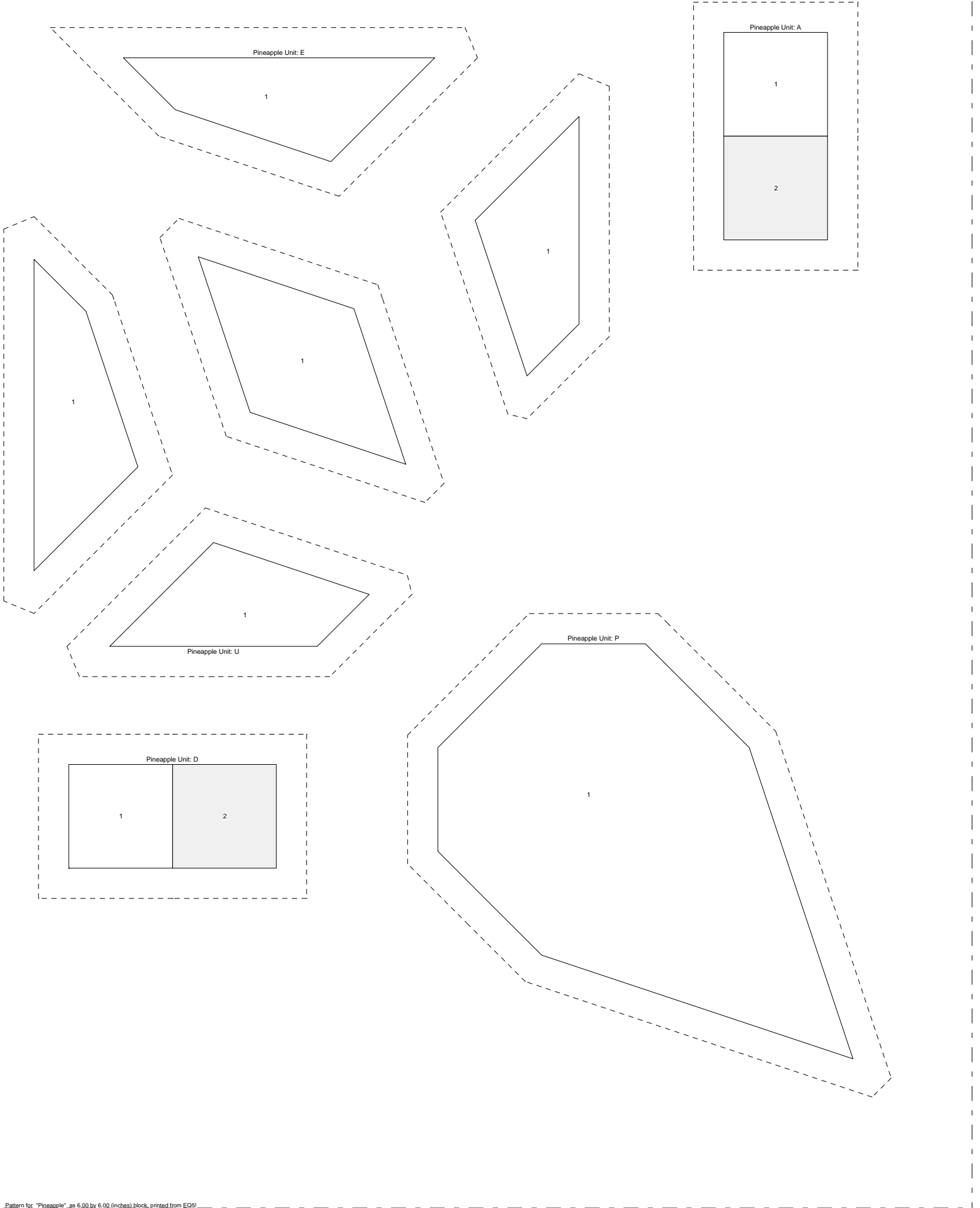

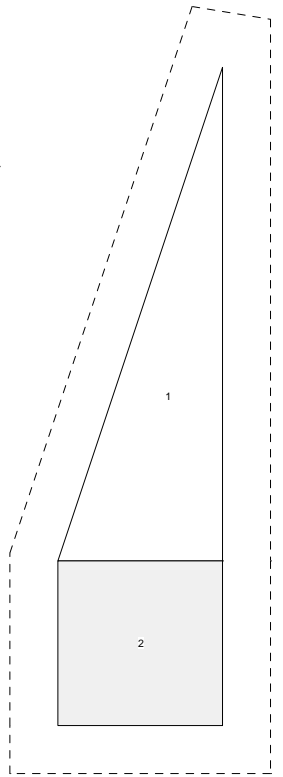
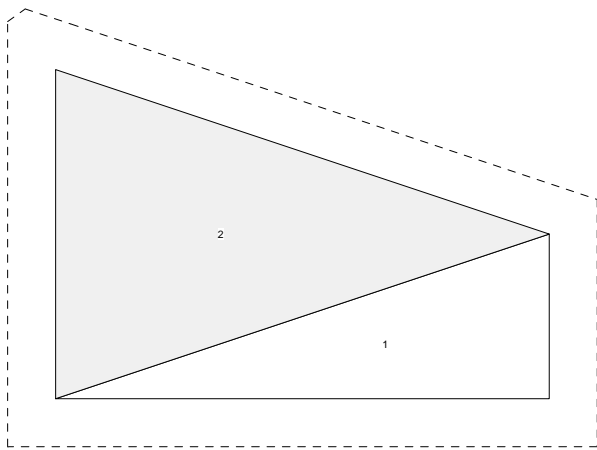
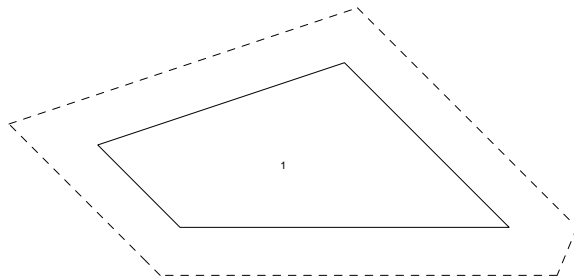
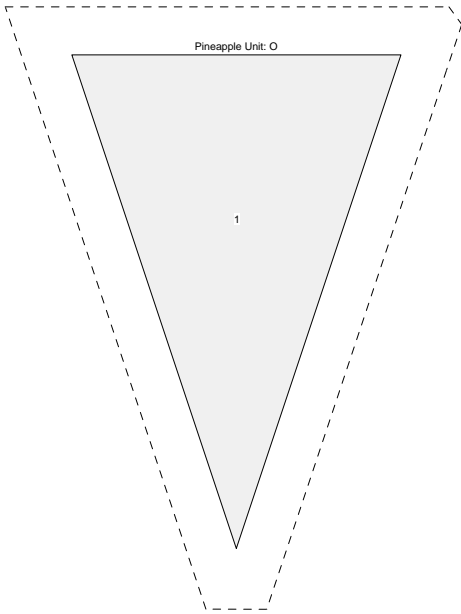
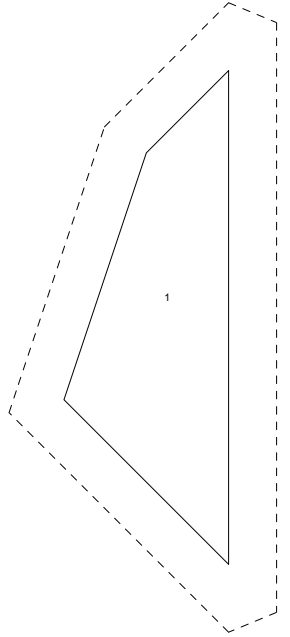
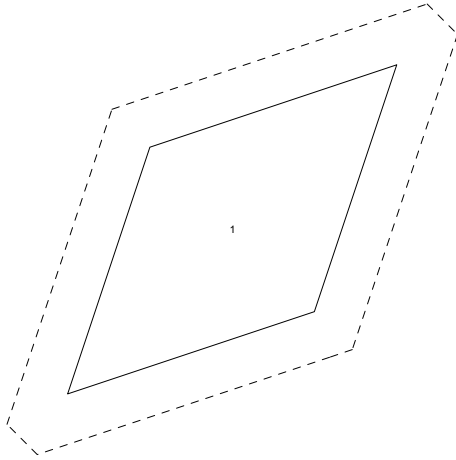
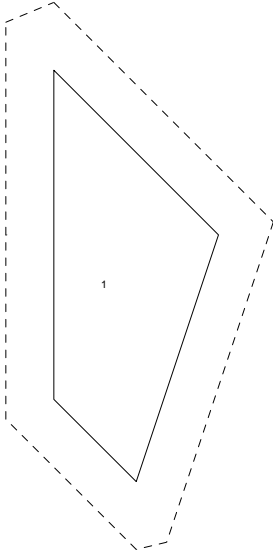
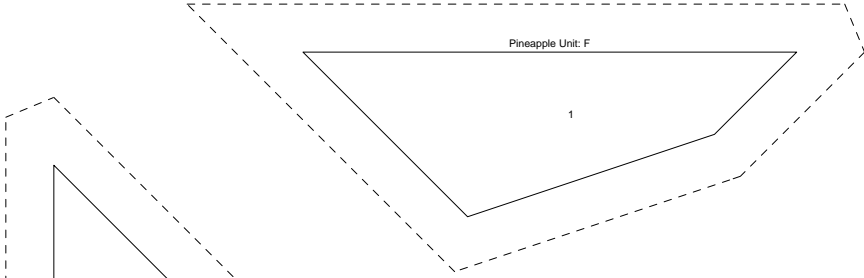
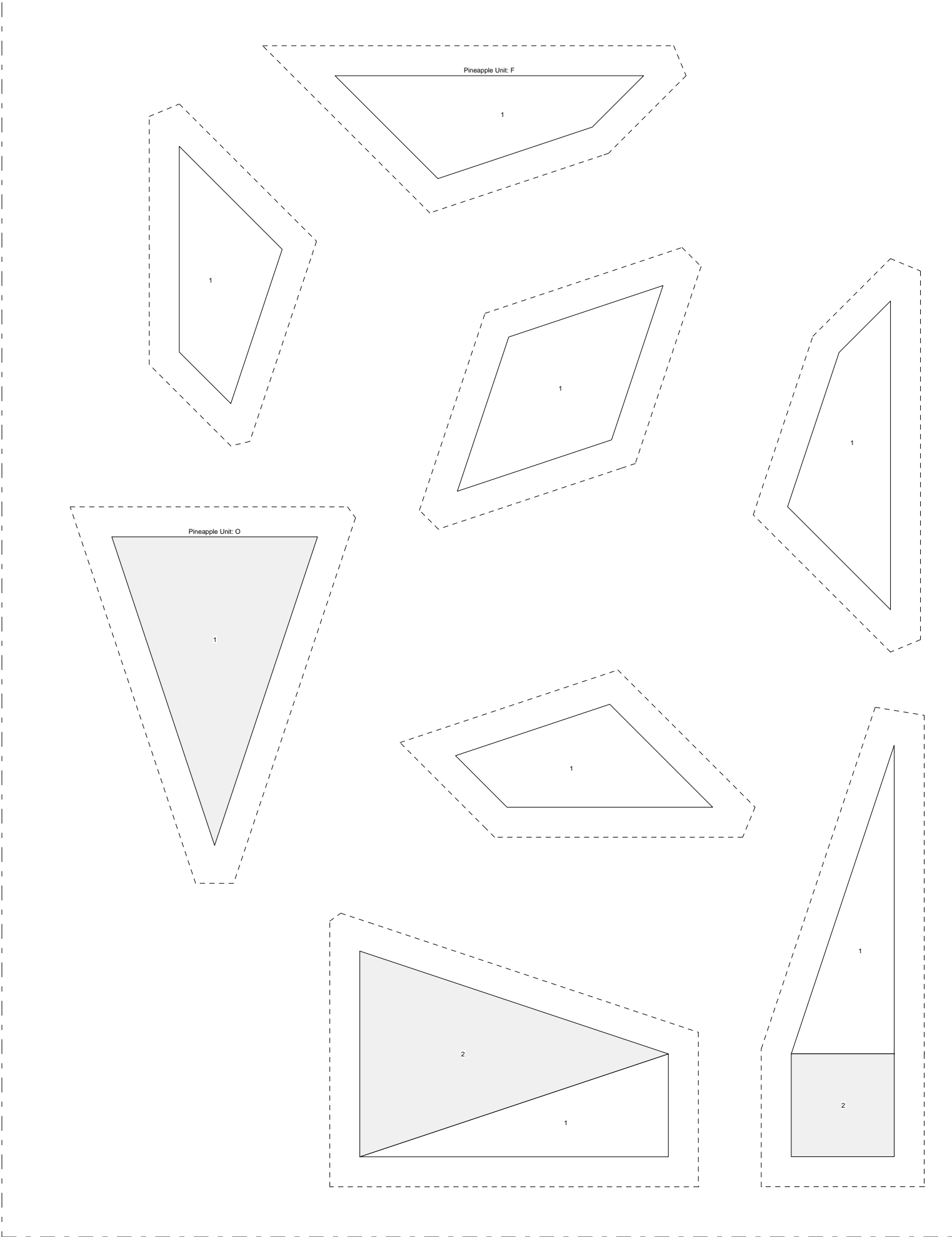

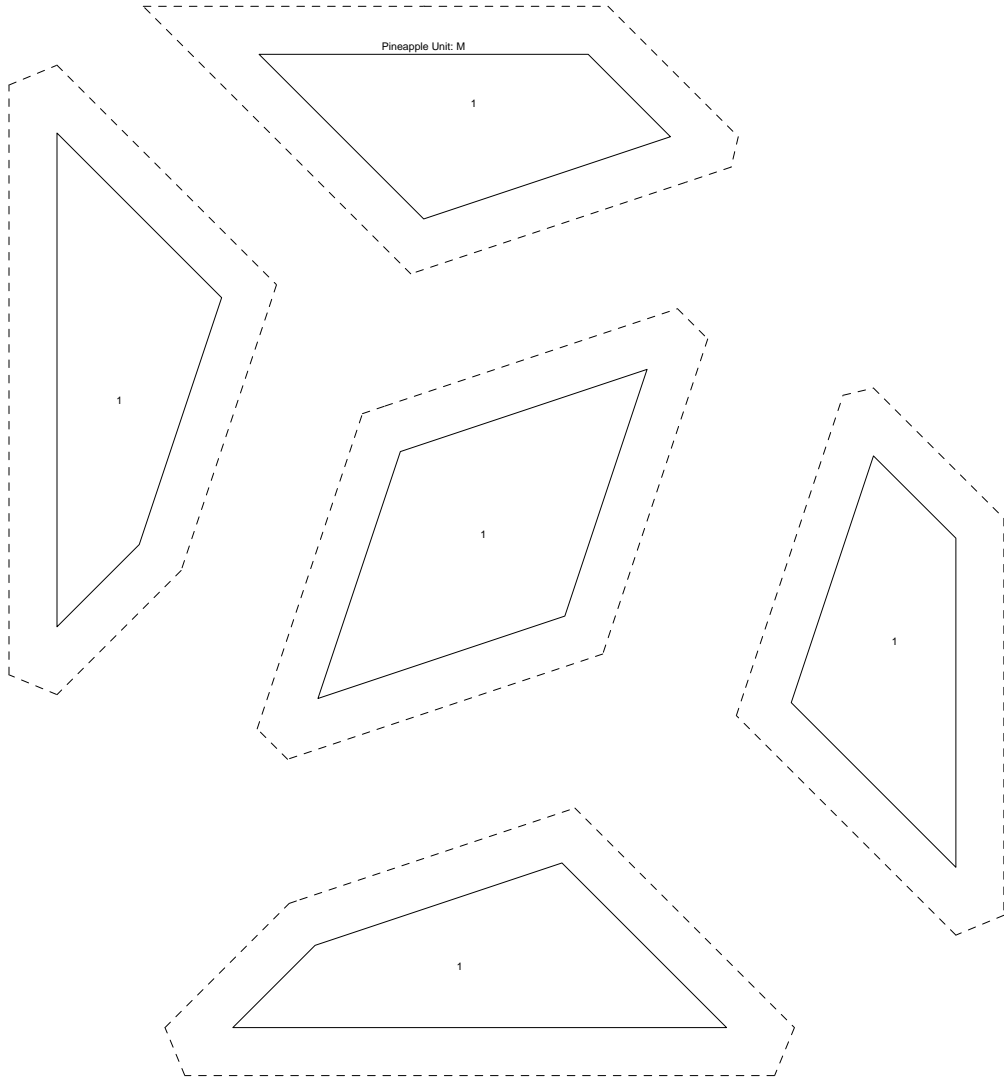

Shady Pine

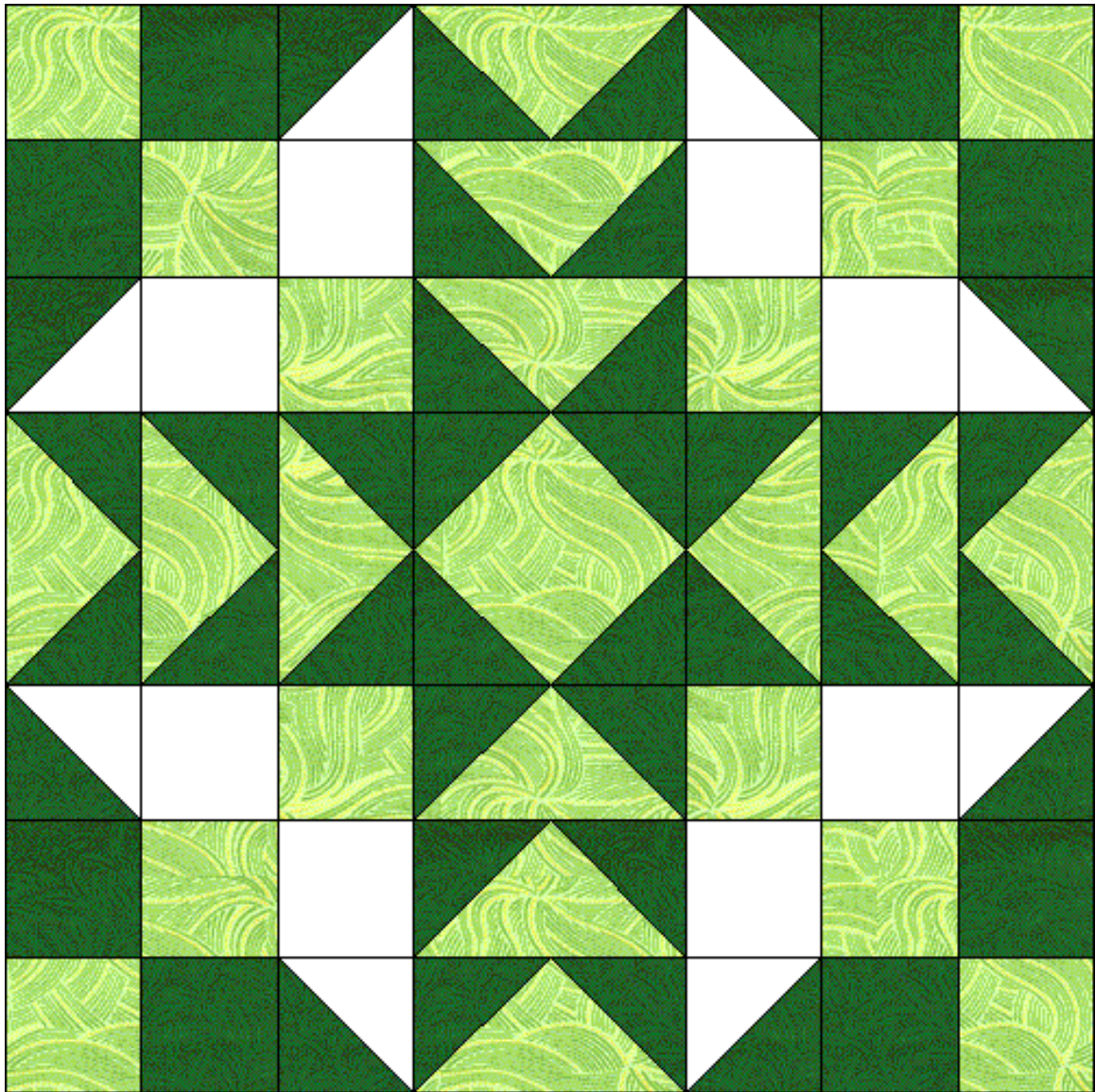

Shady Pine
 Pattern for 8.00x8.00 block
 Key Block (31/100 actual size)

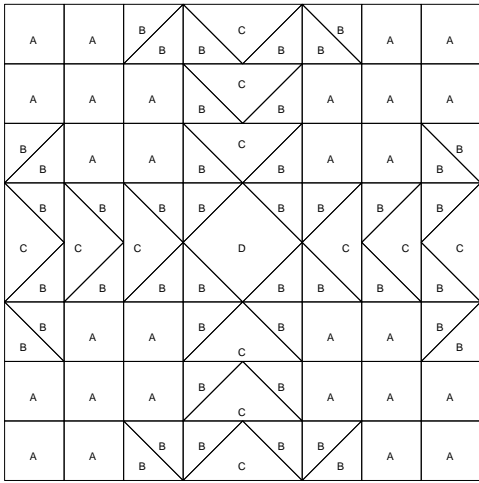

Cutting Diagrams

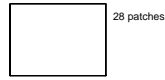

Patch Count

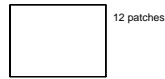
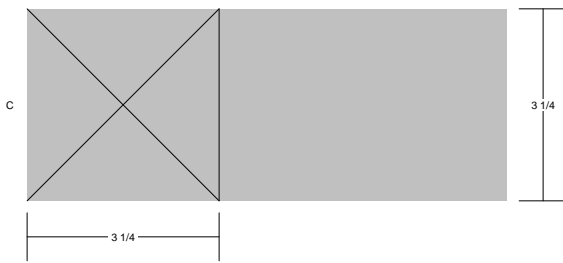
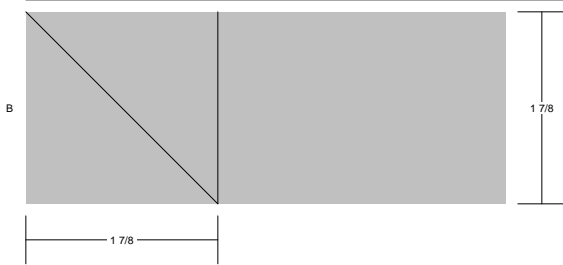



Shady Pine
 Pattern for 8.00x8.00 block
 Key Block (43/100 actual size)

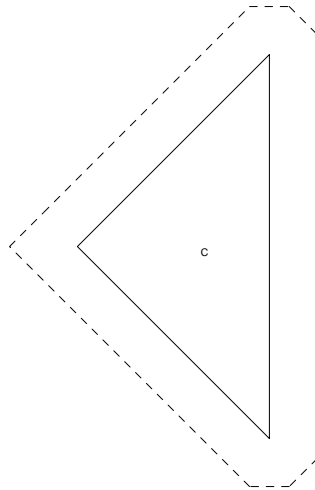
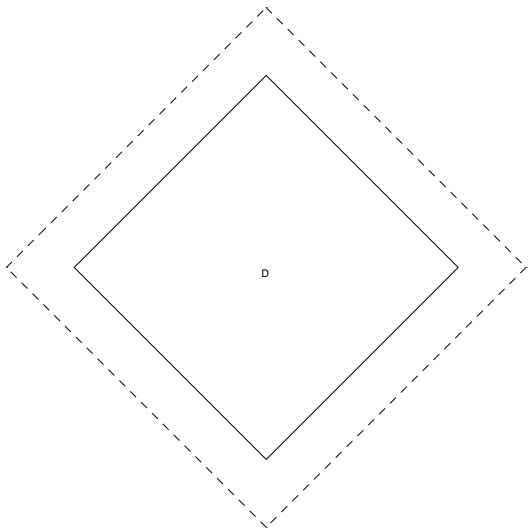
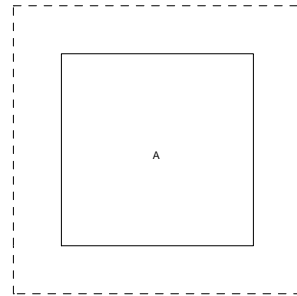
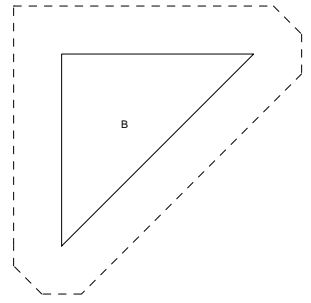
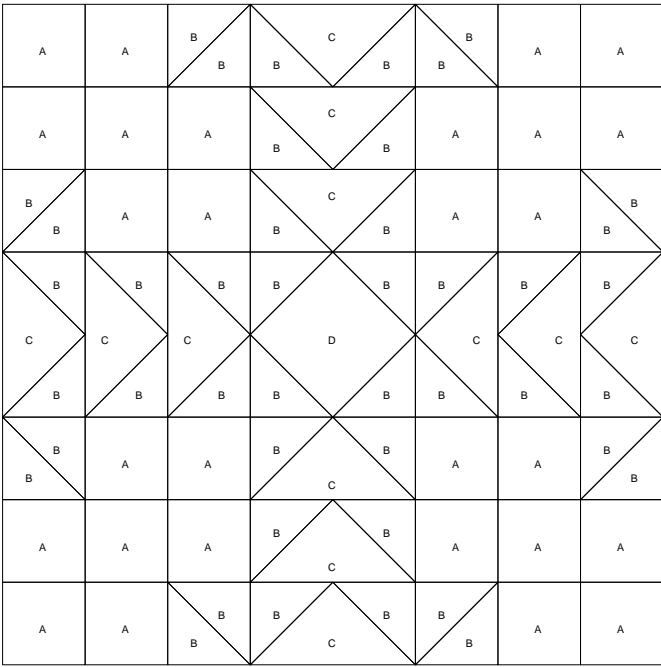

Shady Pine

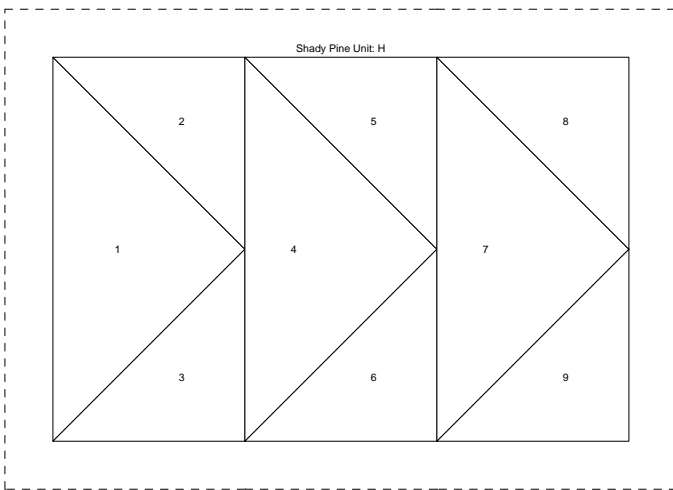
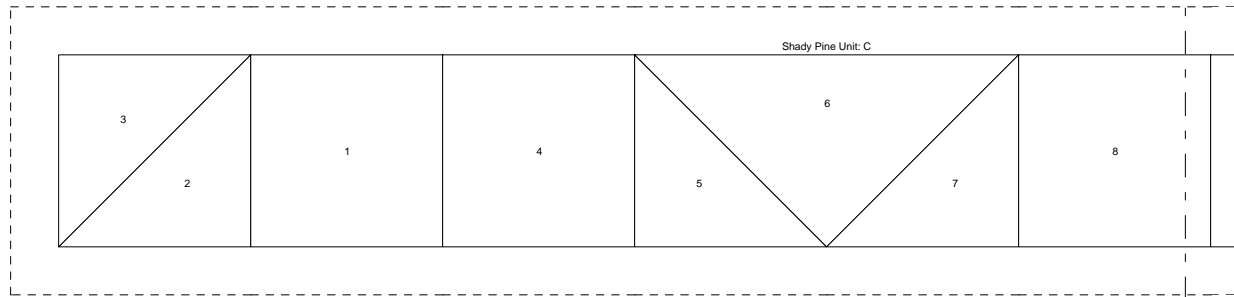
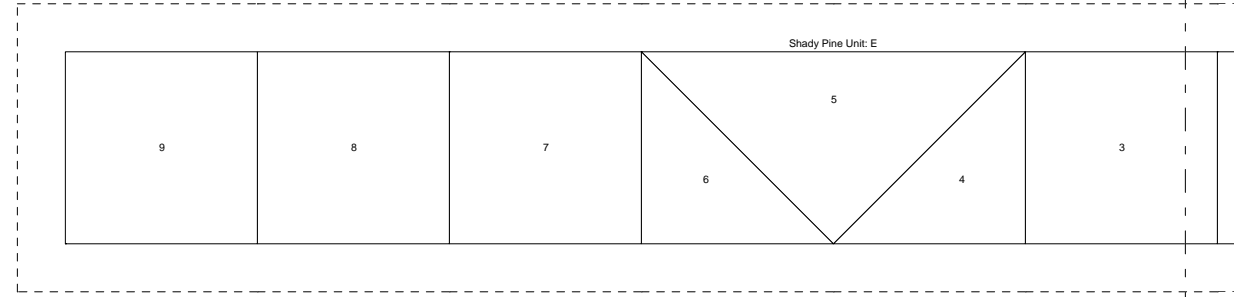
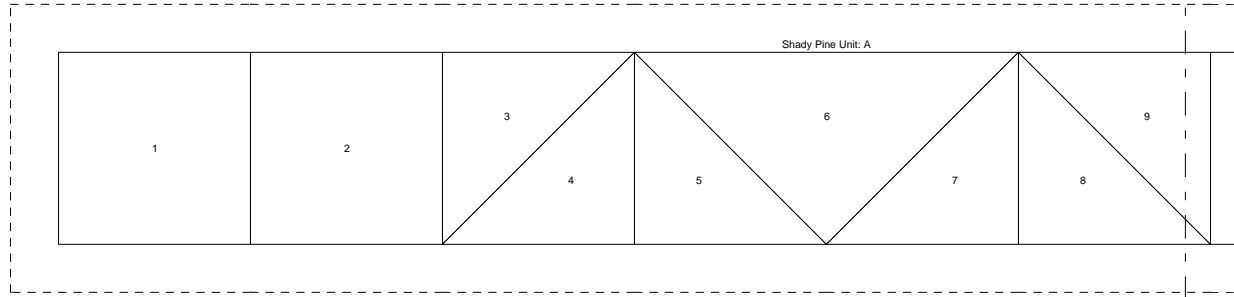

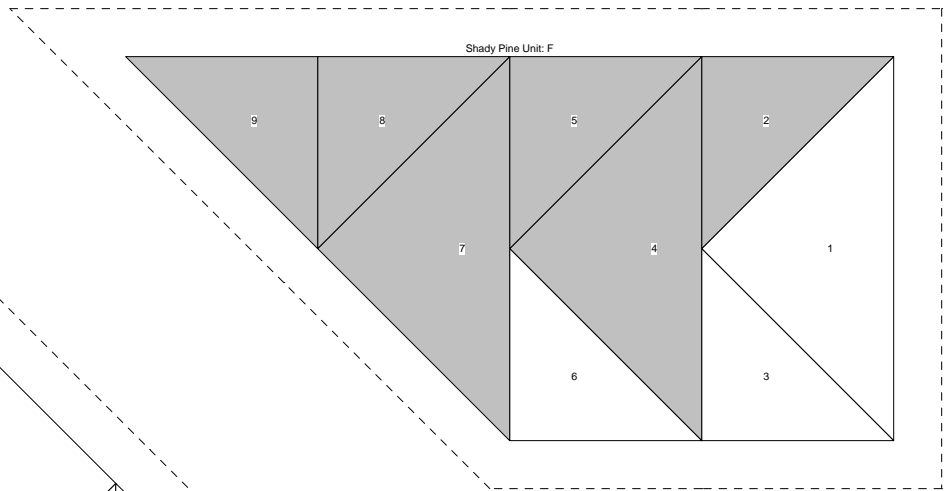
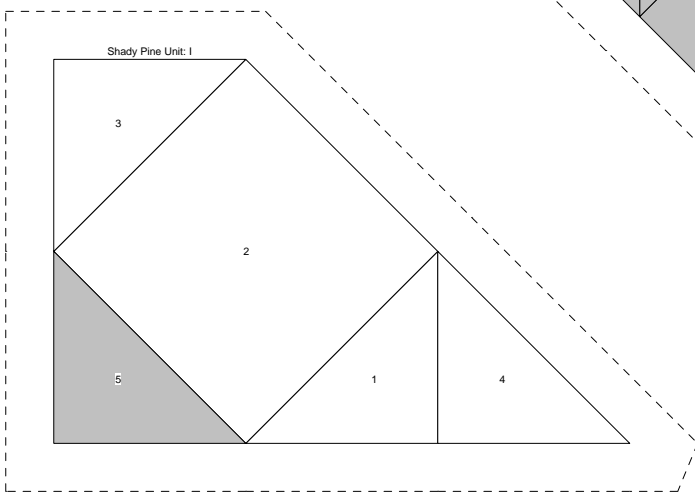
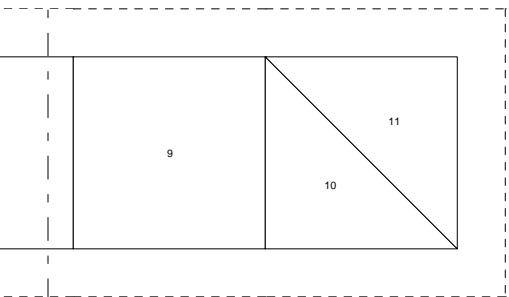
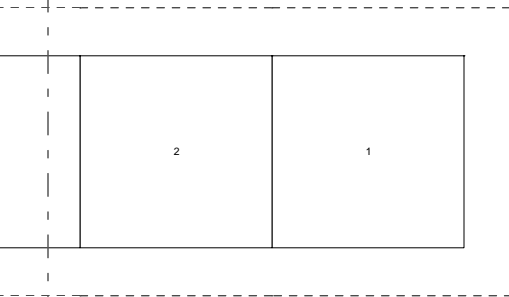
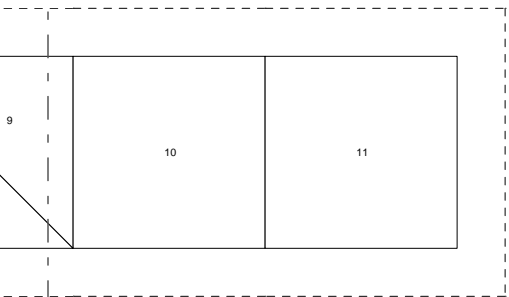

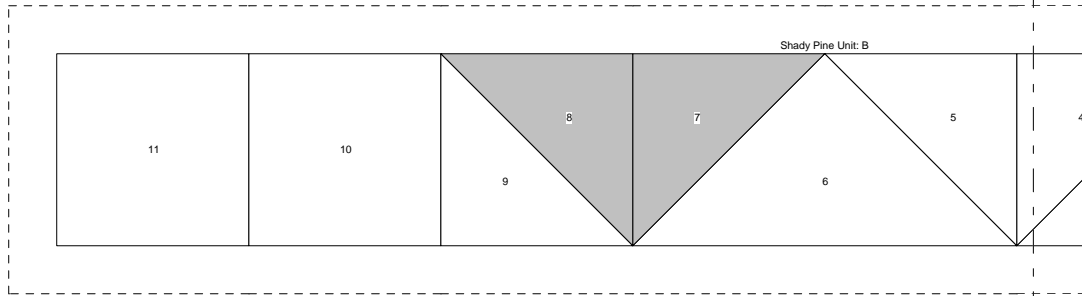
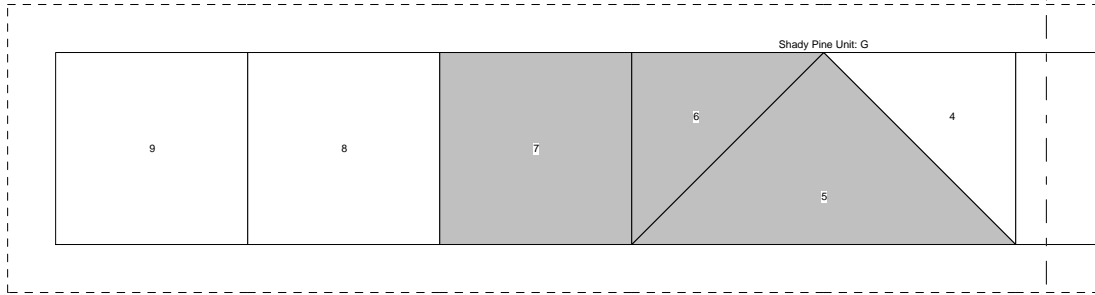
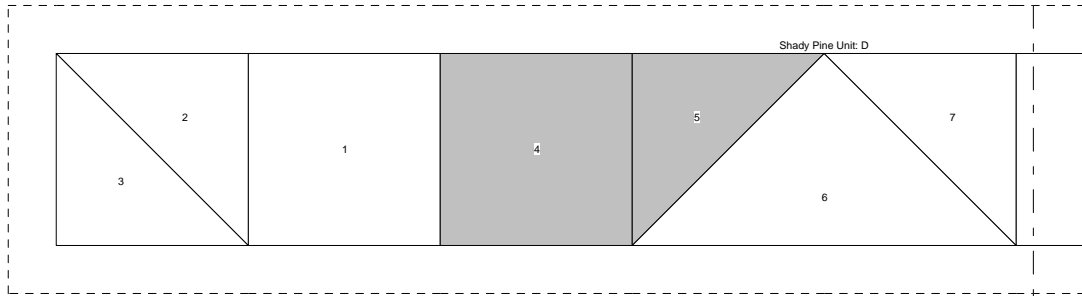

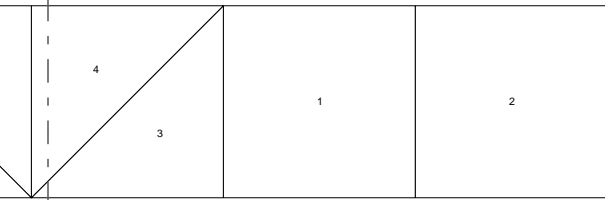
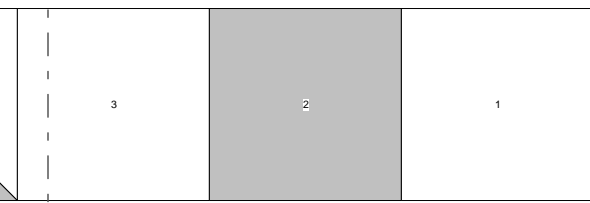
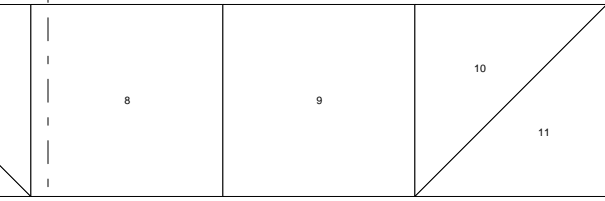

Skyrocket

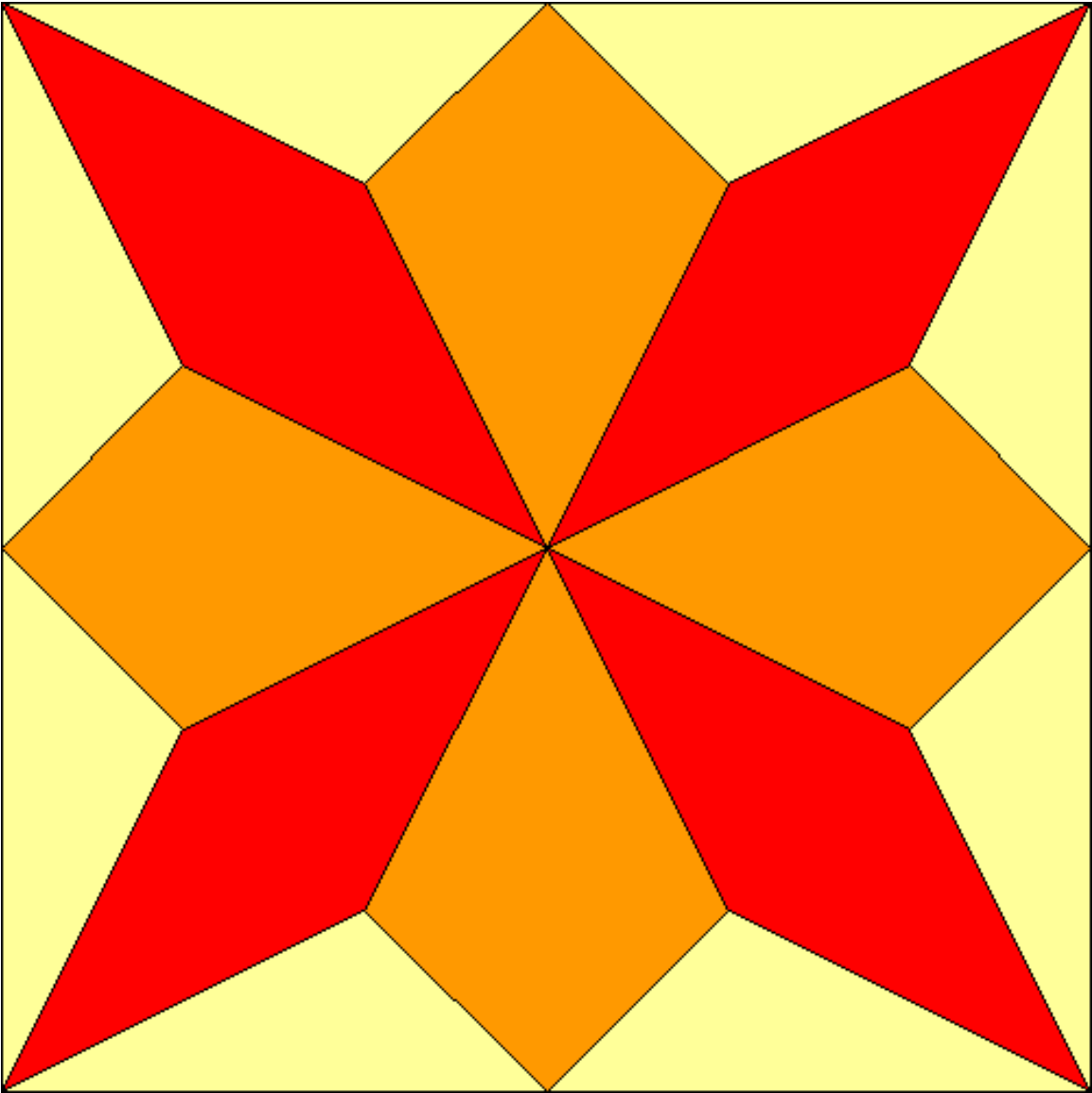

Skyrocket
 Pattern for 12.00x12.00 block
 Key Block (1/5 actual size)

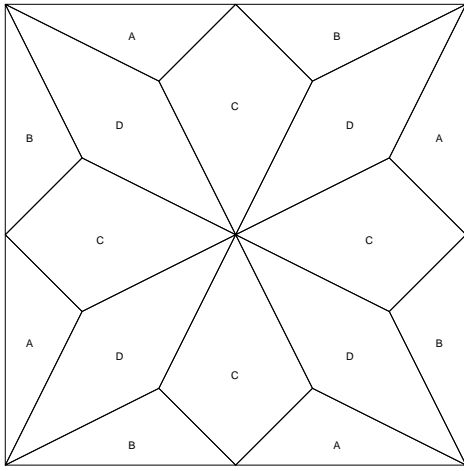

Cutting Diagrams

Patch Count

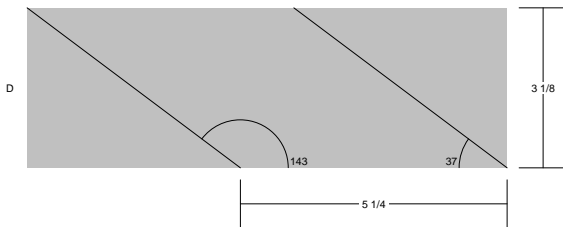
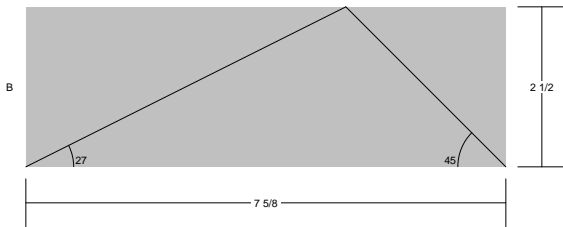
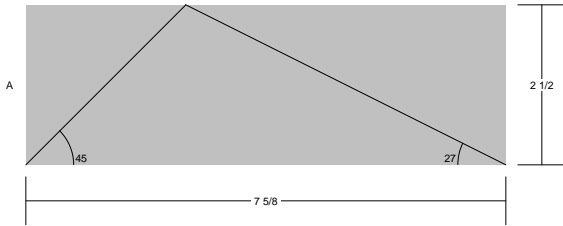

Skyrocket
Pattern for 12.00x12.00 block
Key Block (29/100 actual size)

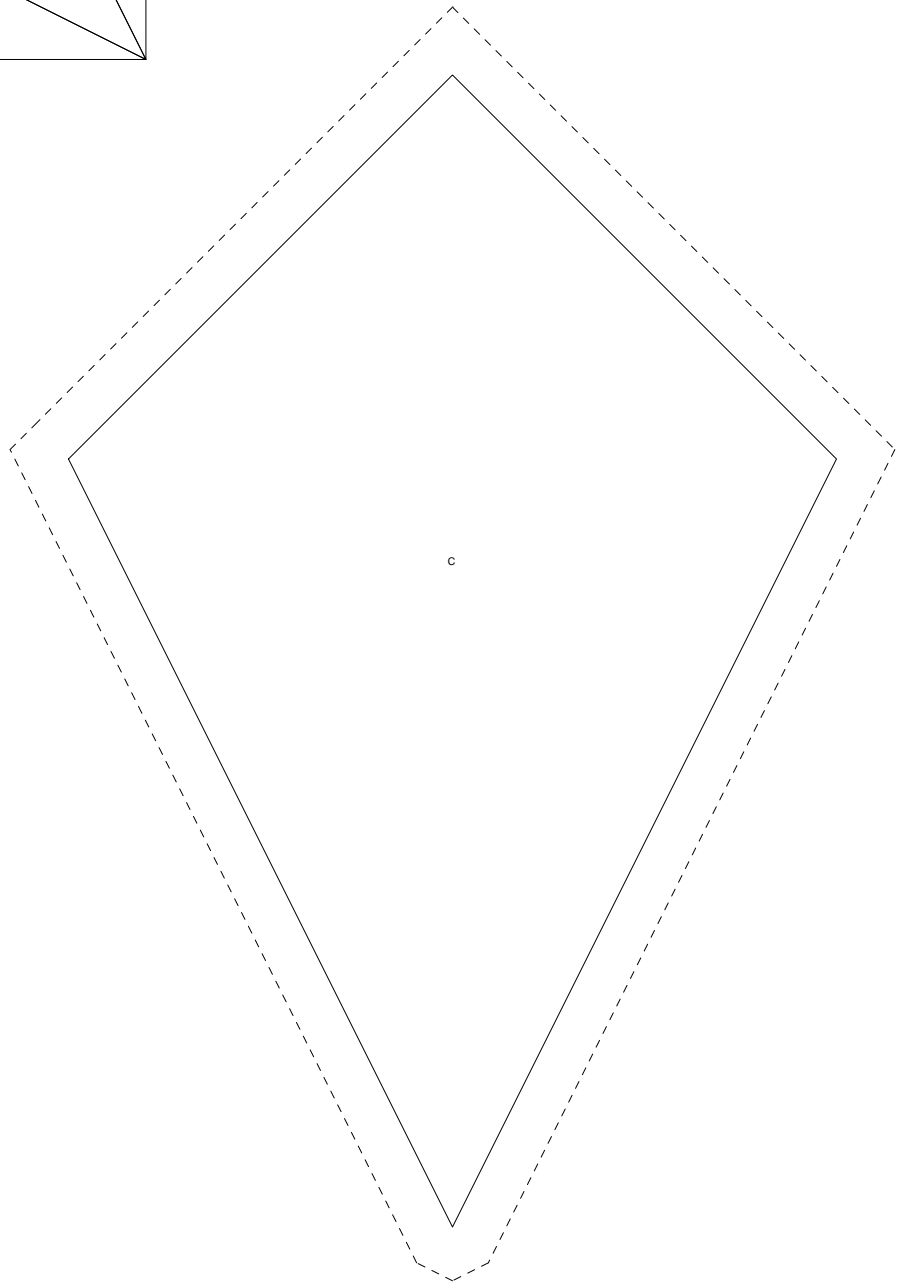
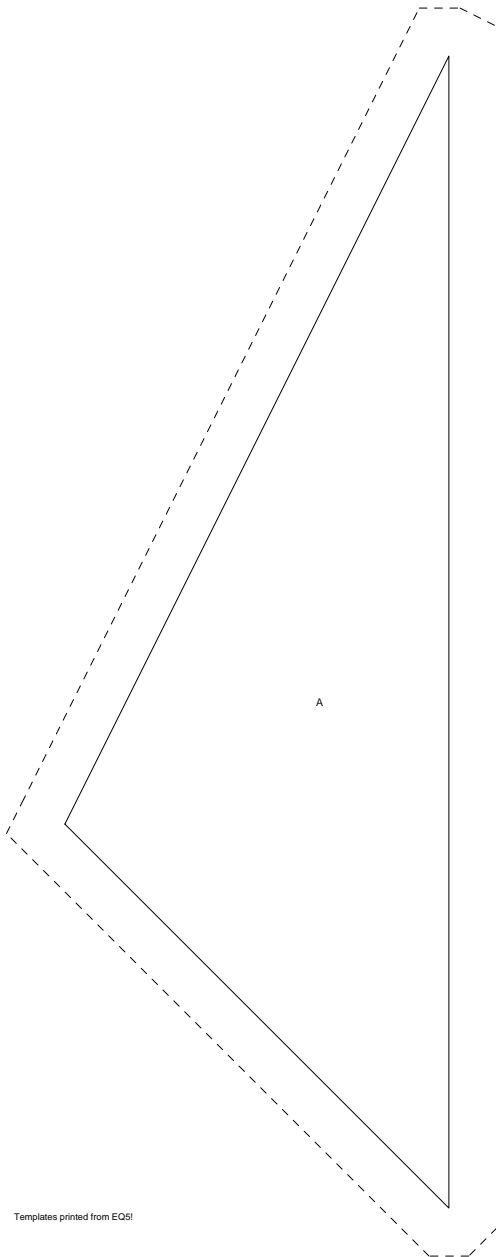
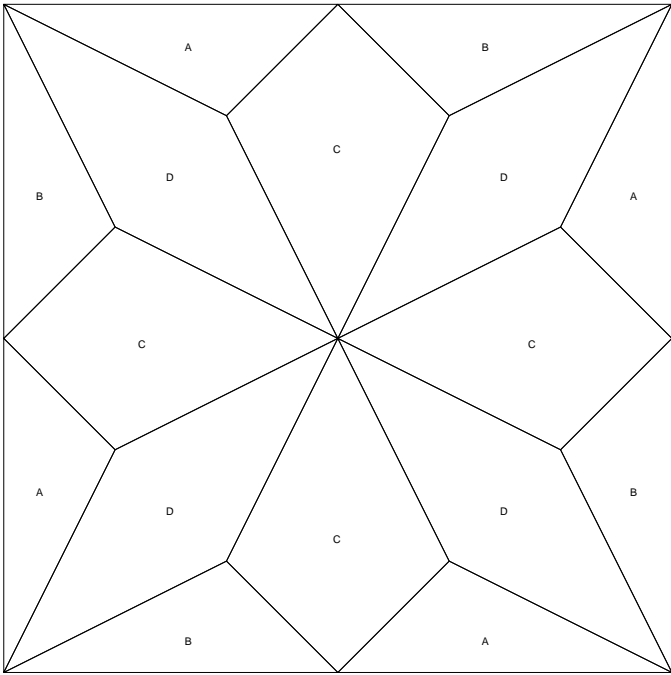

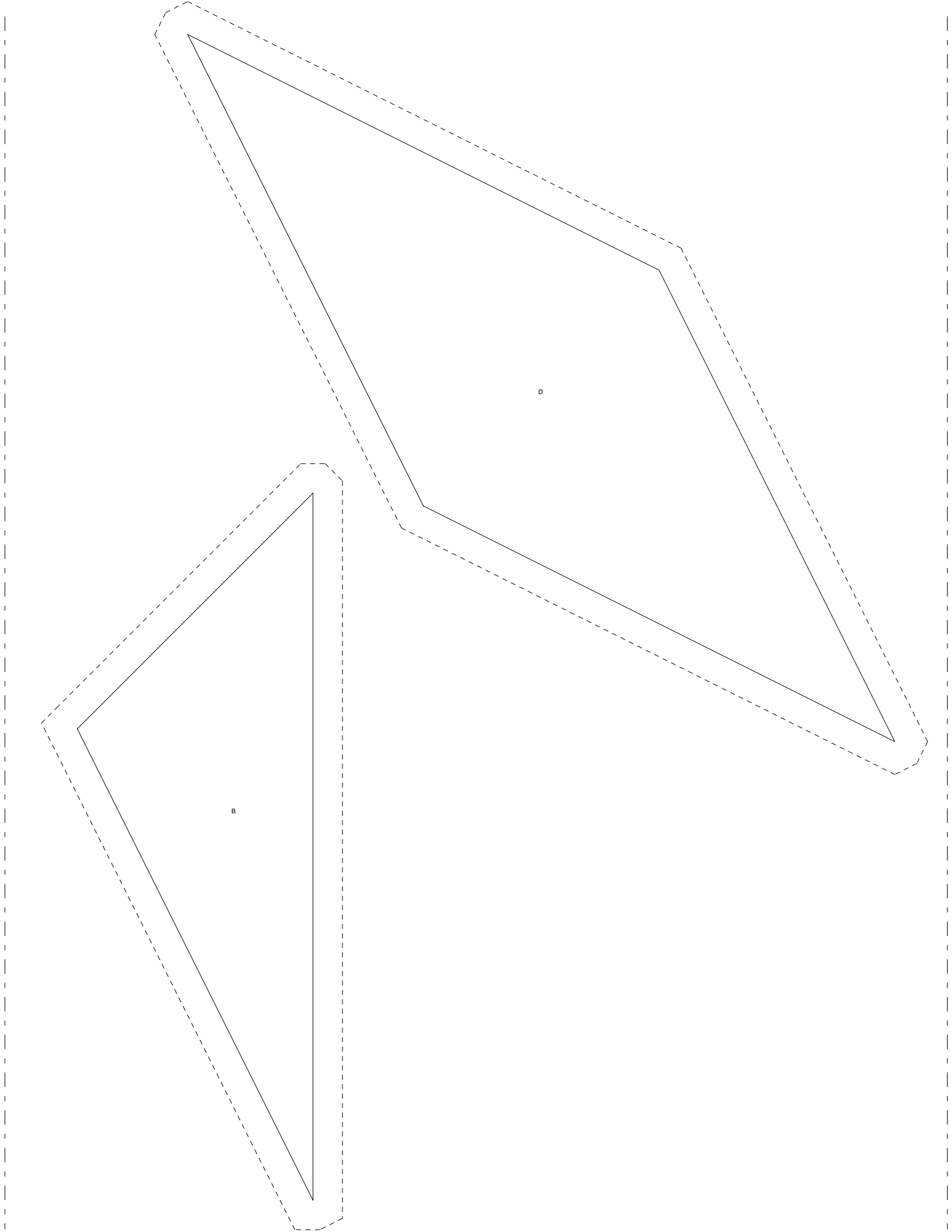

B

D

Skyrocket

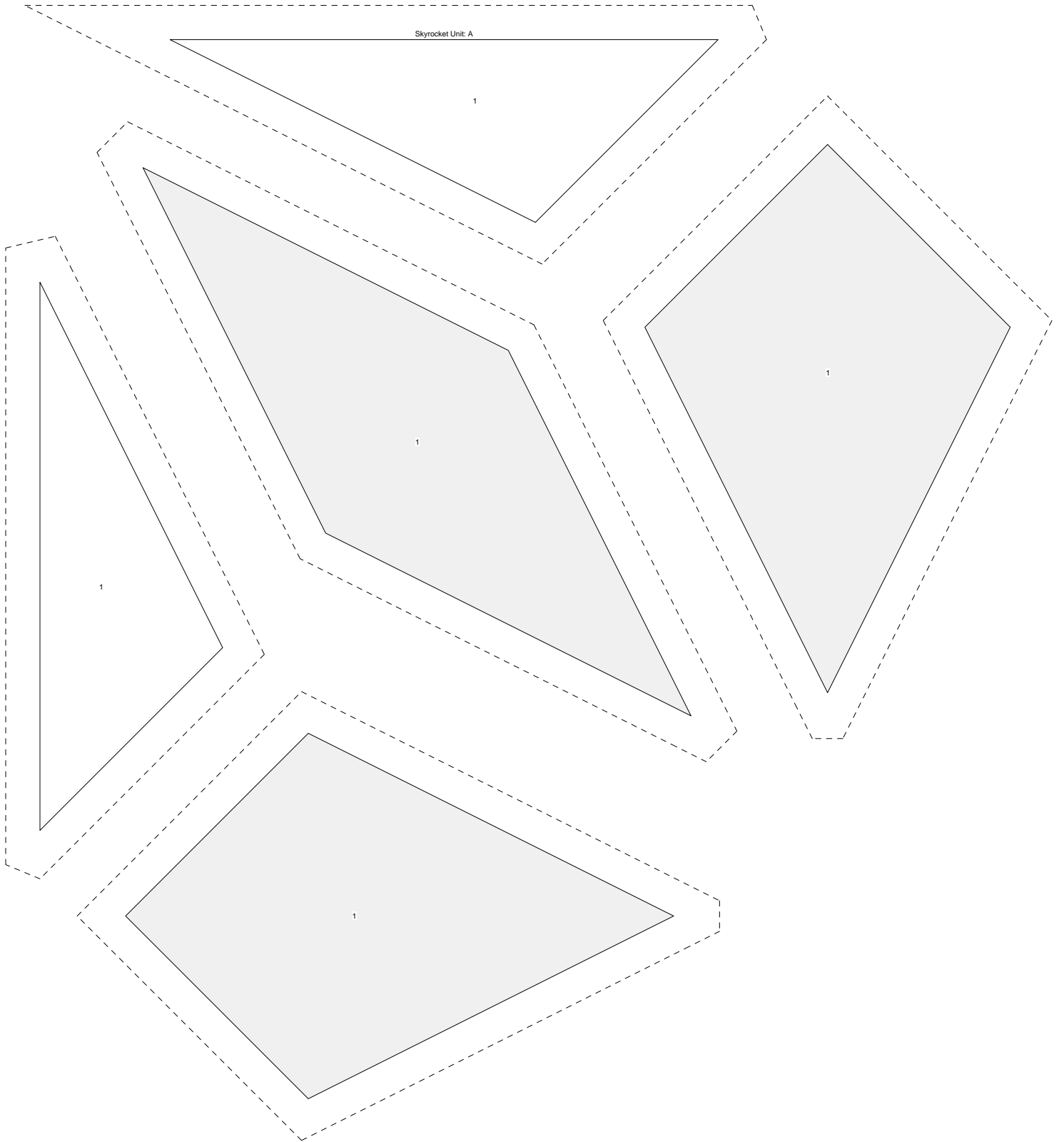

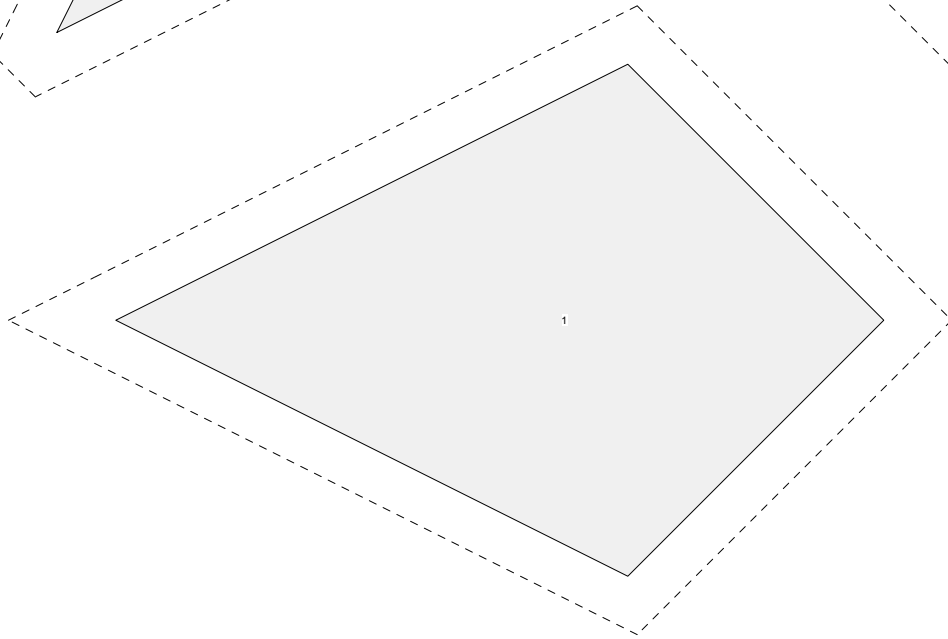
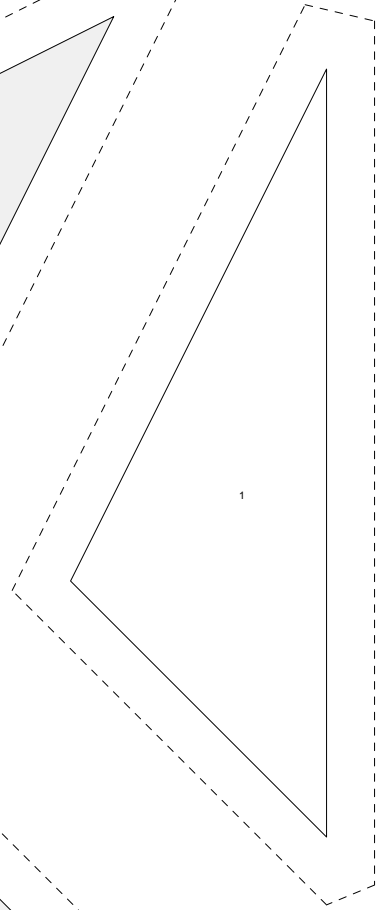
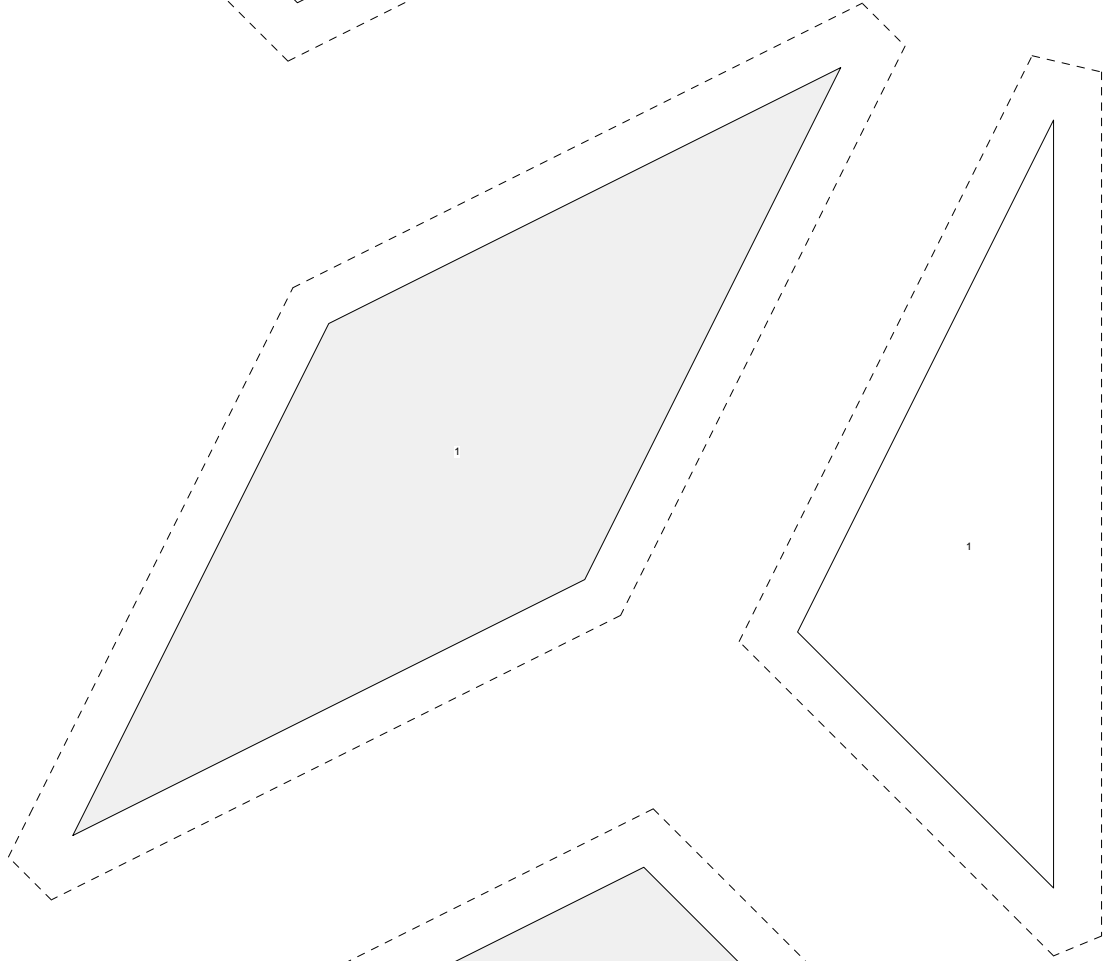
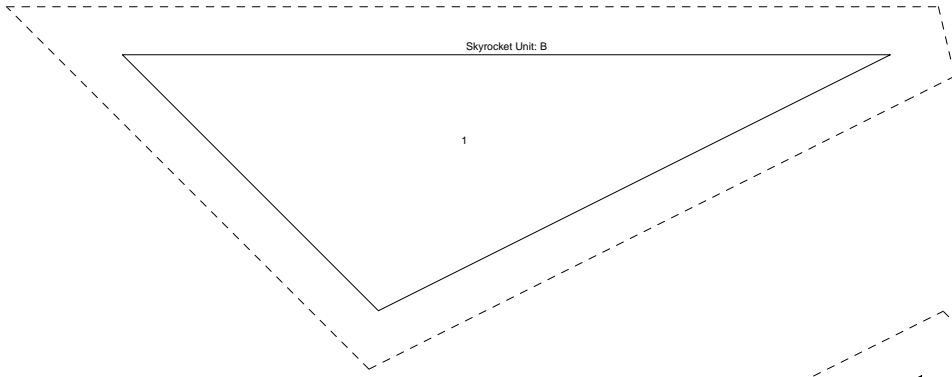

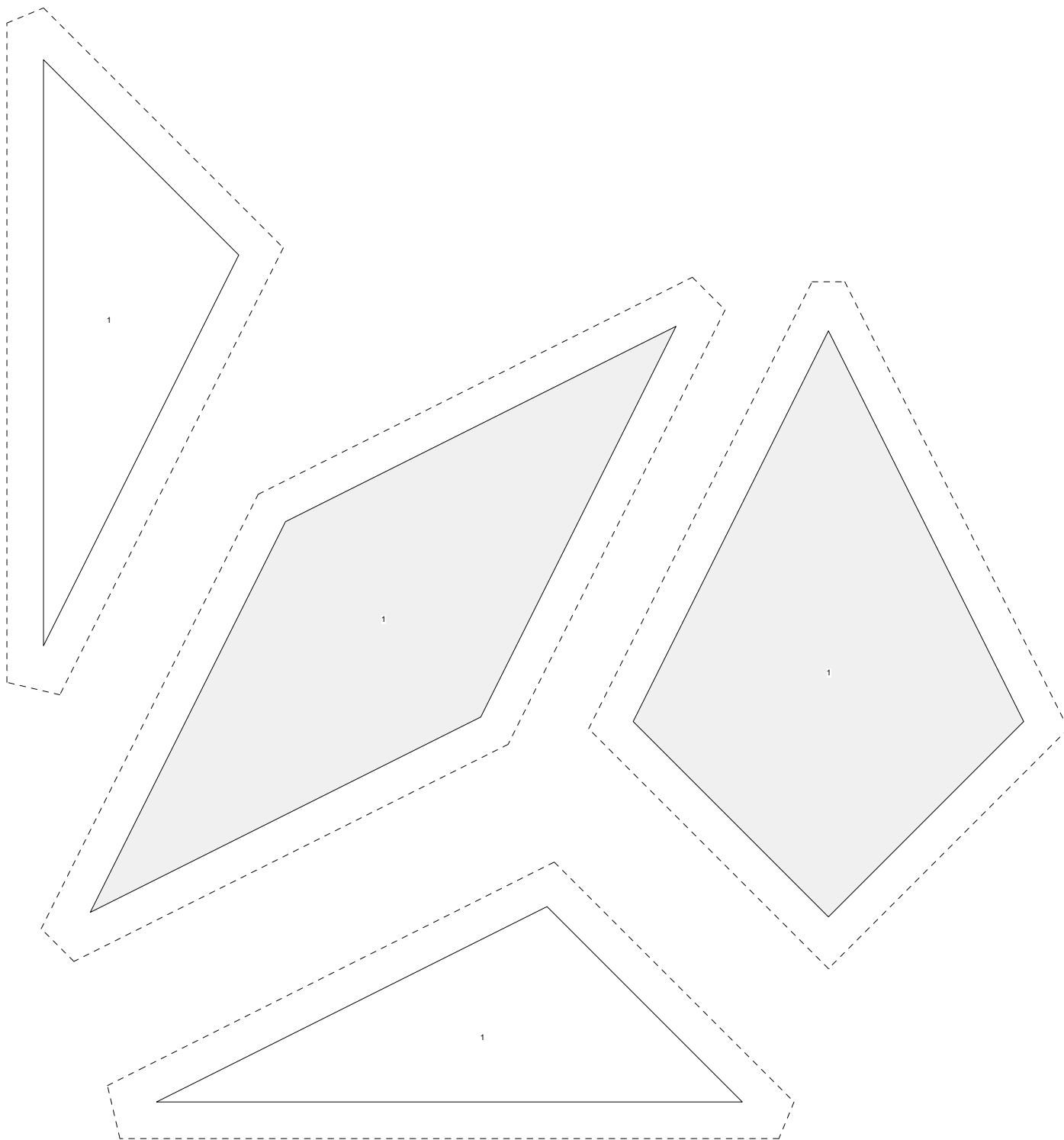

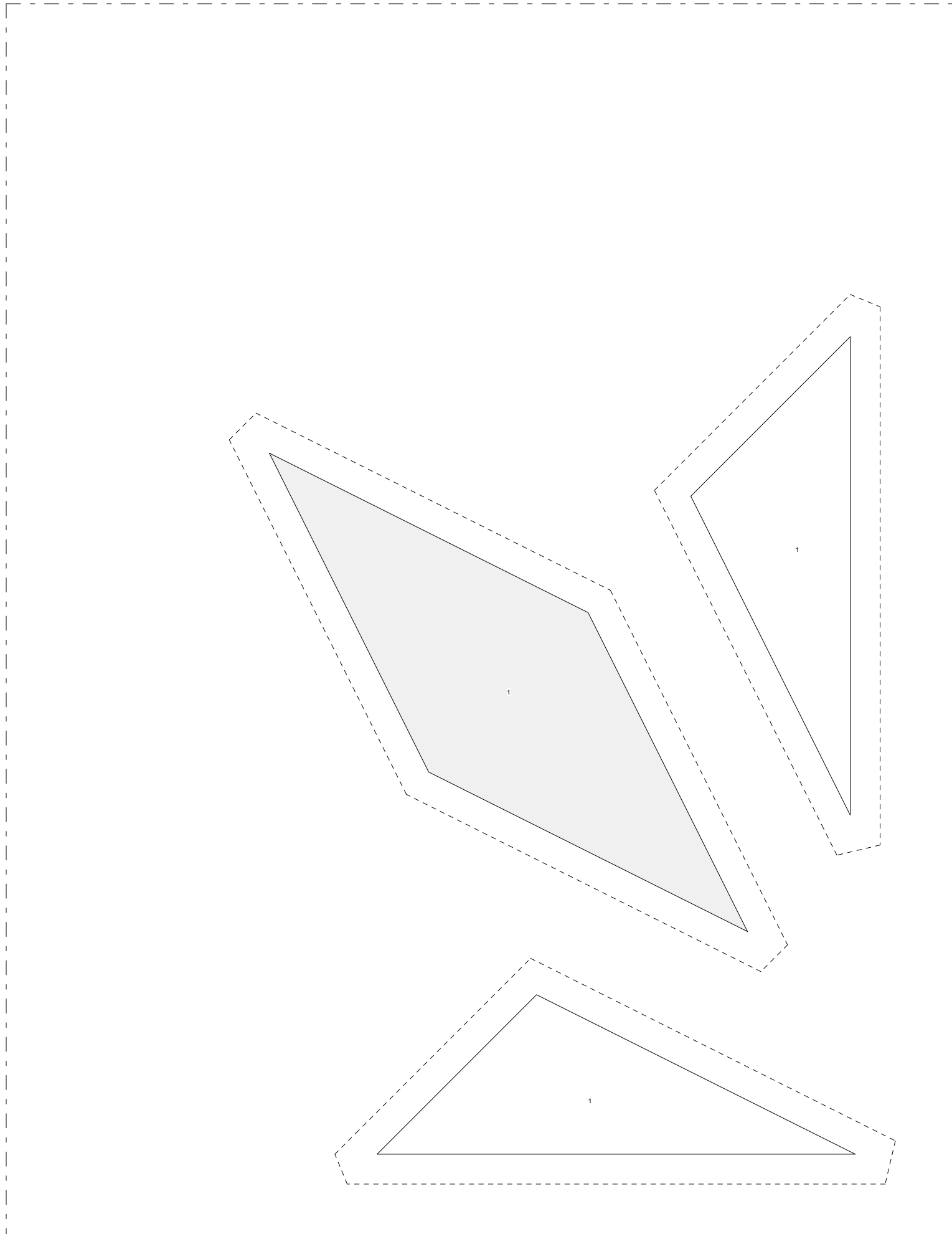

Sunshiny Day

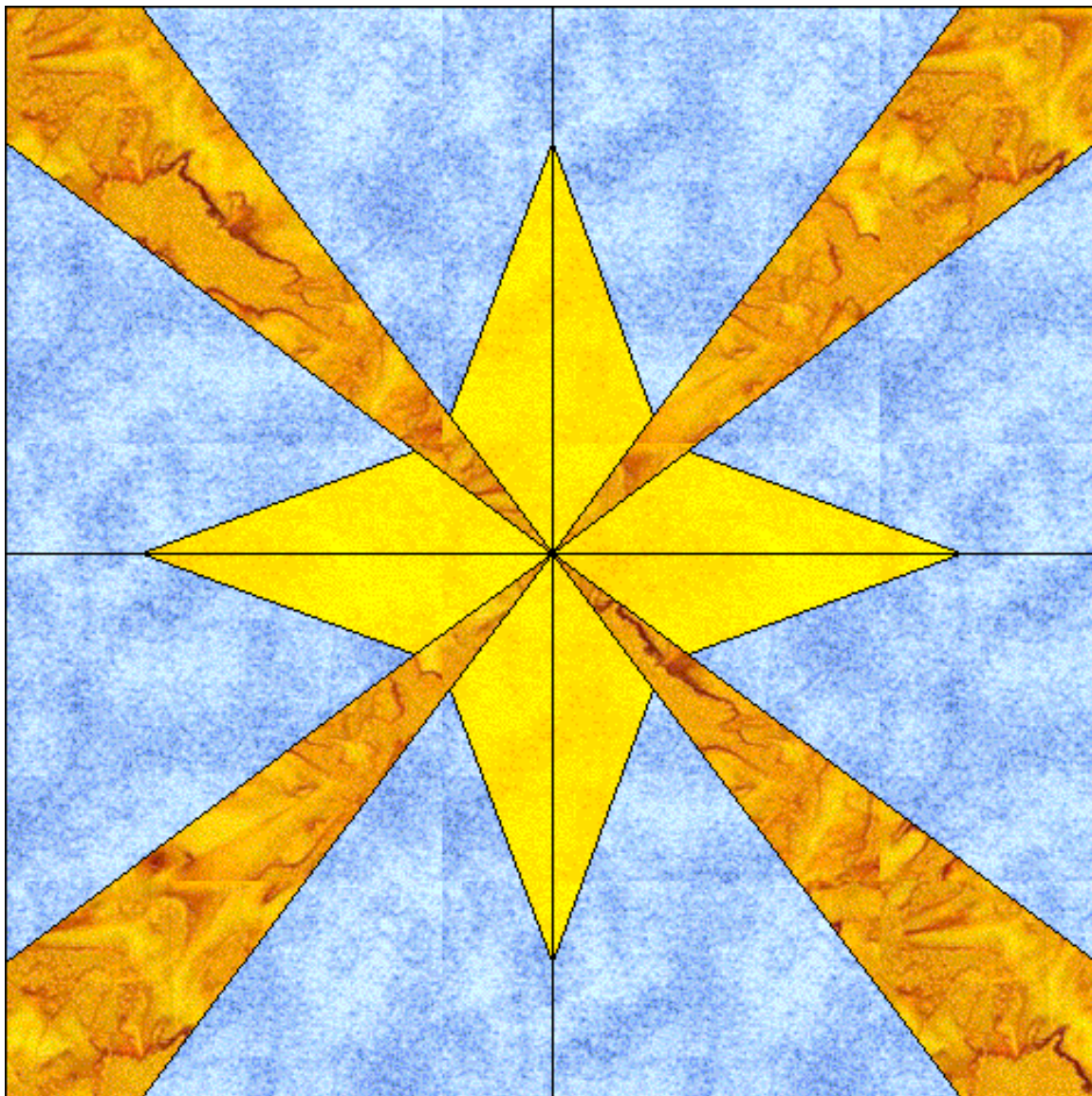

Sunshiny Day

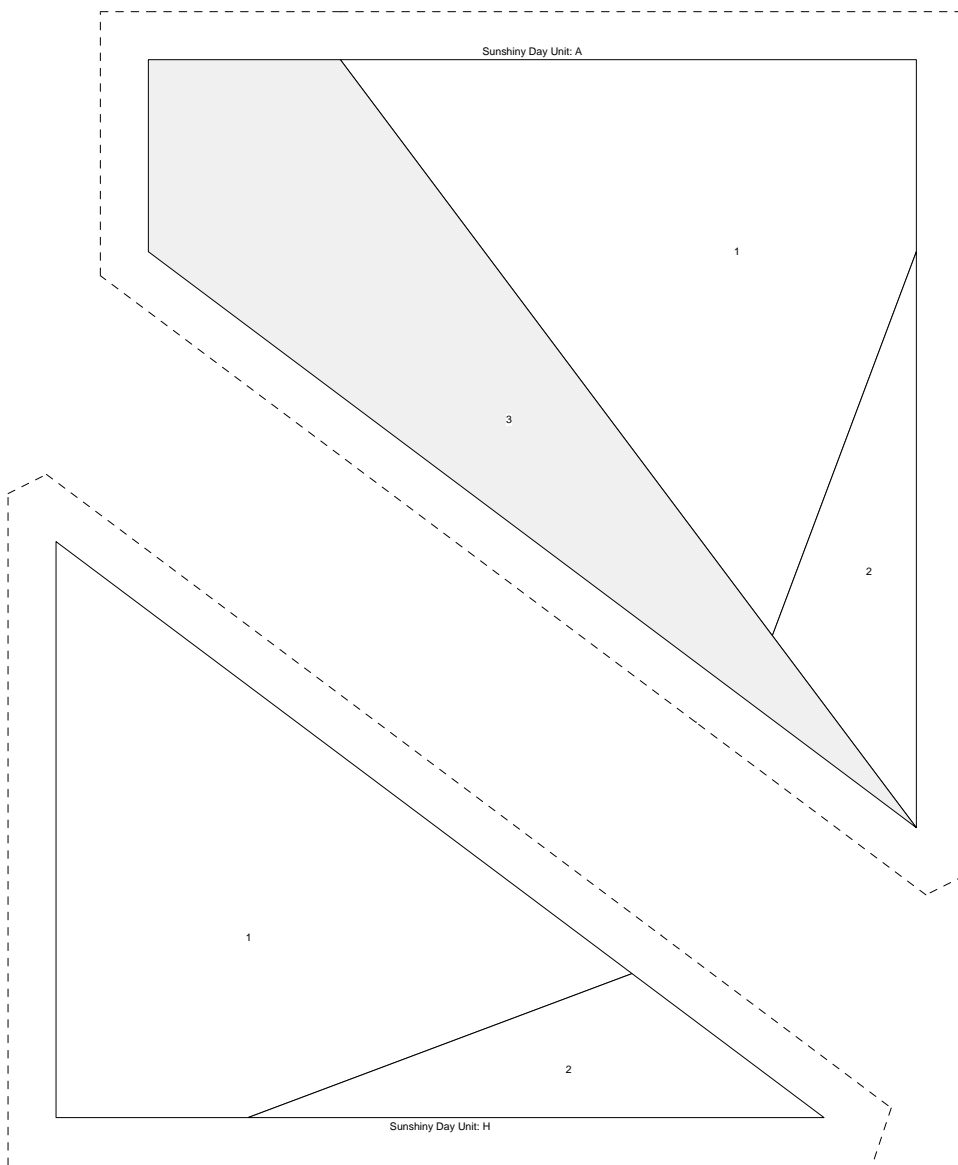

Sunshiny Day Unit: B

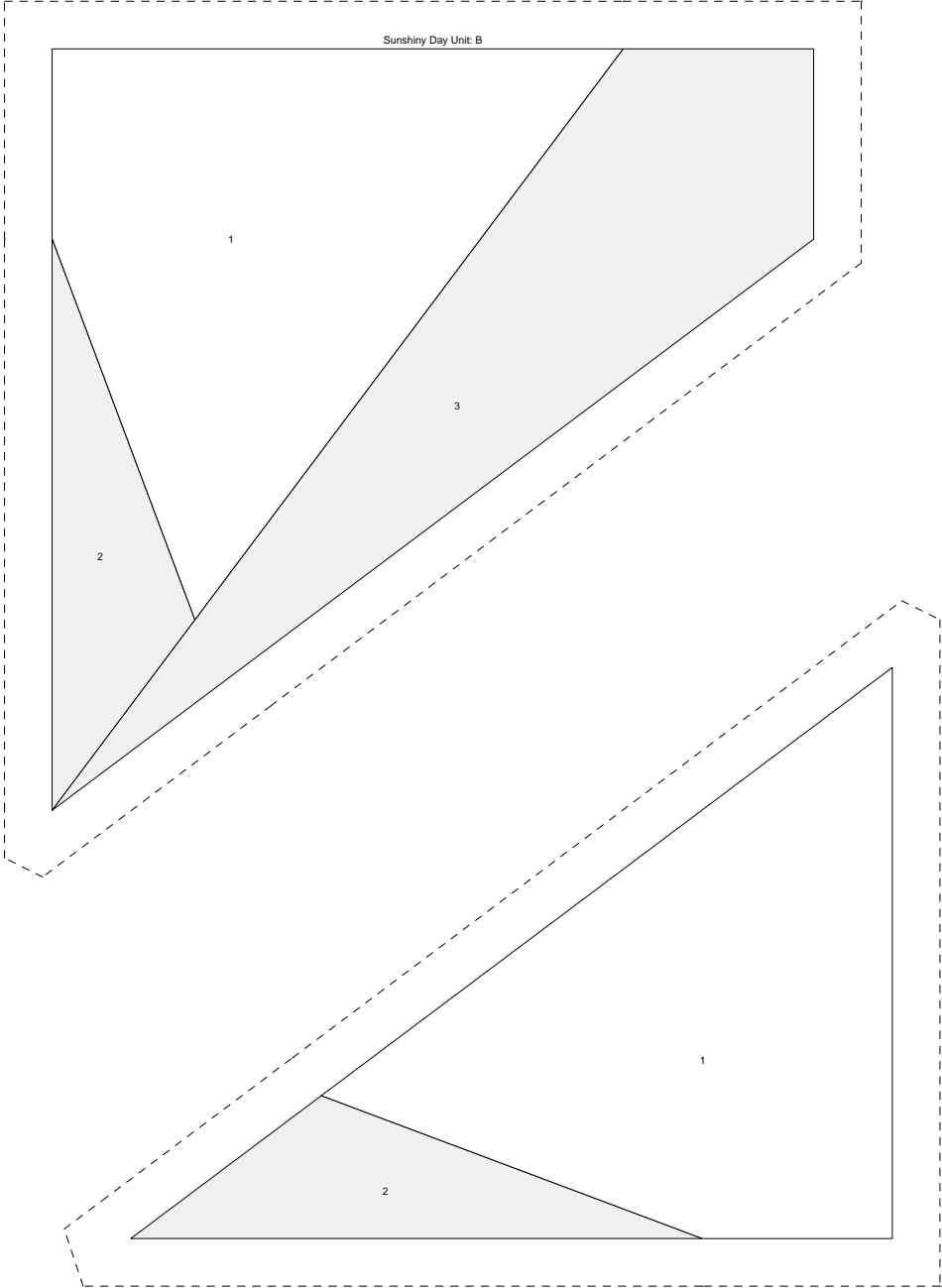

Sunshiny Day Unit: G

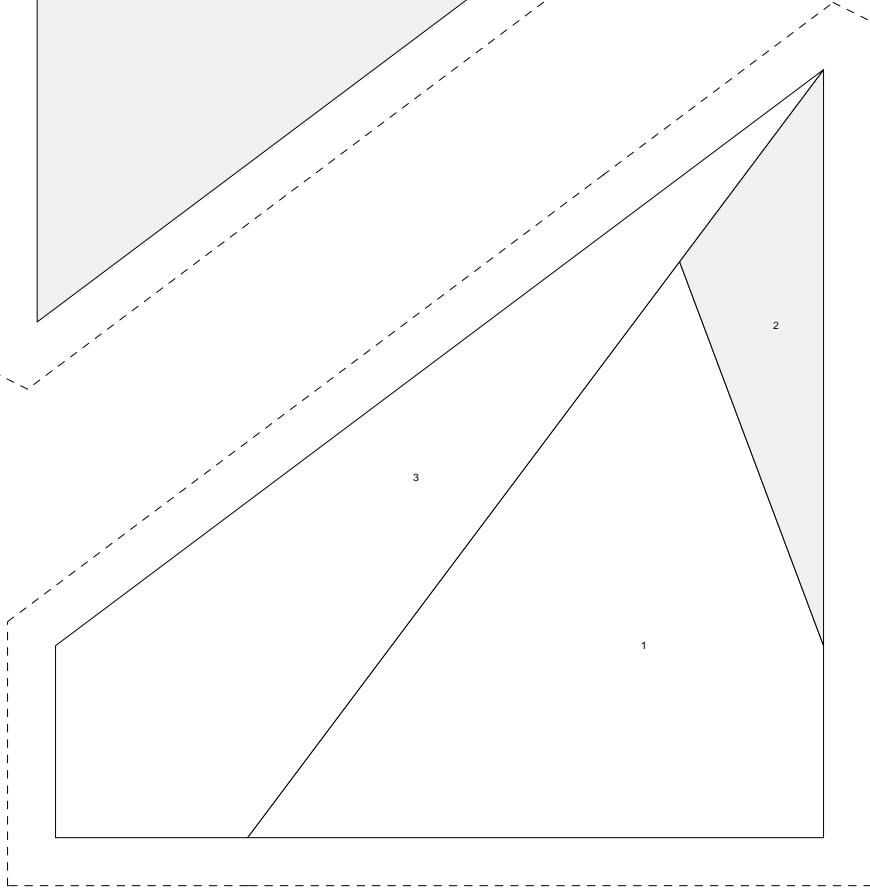
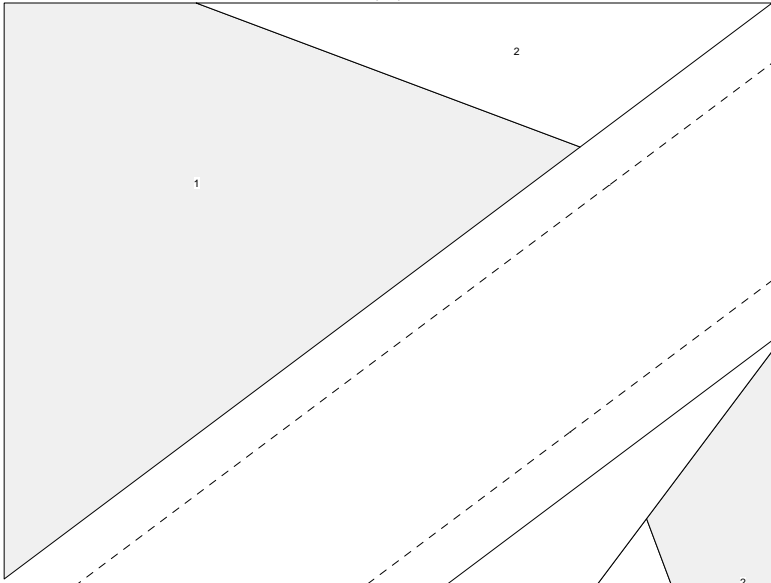

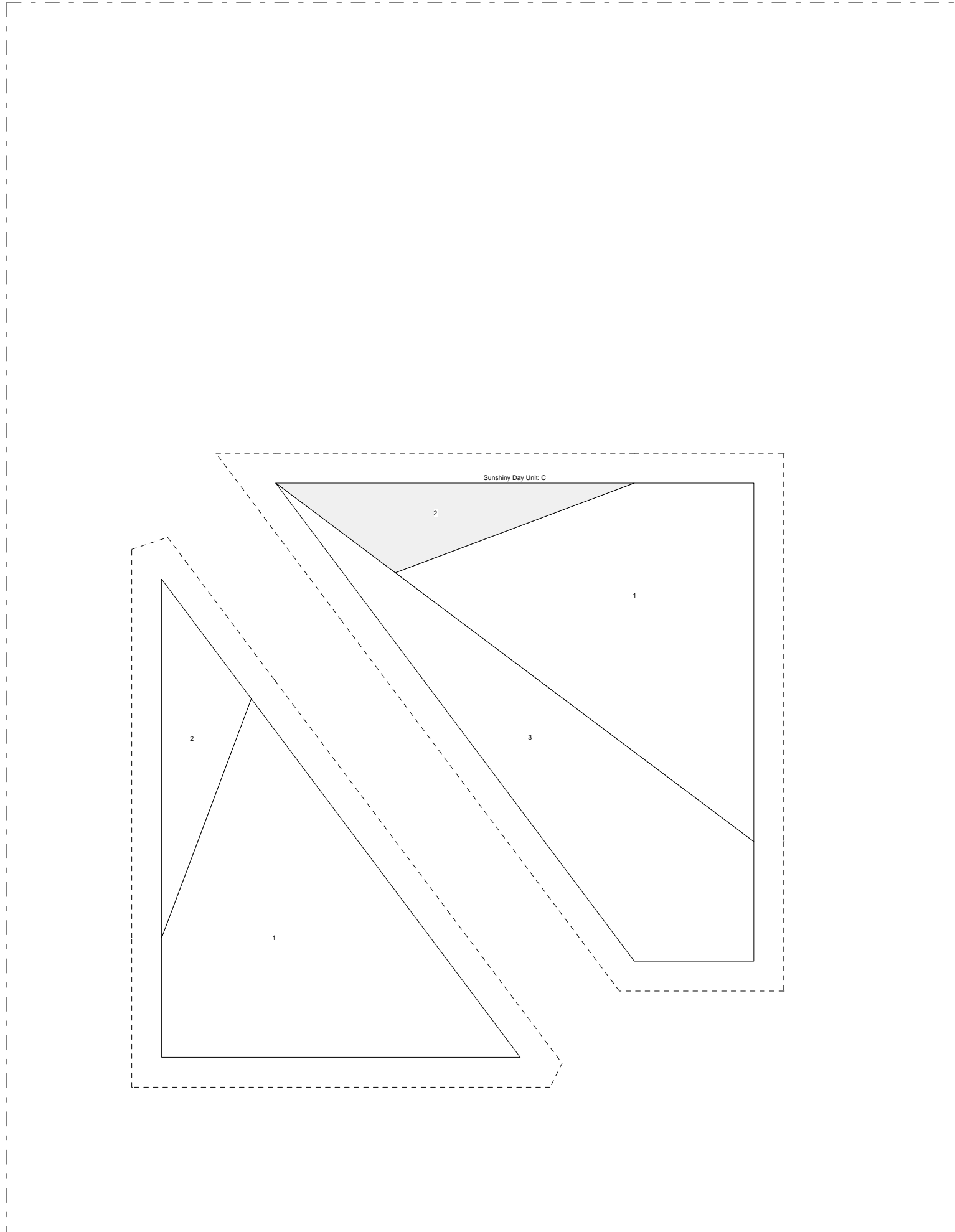

Sunshiny Day Unit: C

2

1

2

3

1

Sunshiny Day
Pattern for 8.00x8.00 block
Key Block (43/100 actual size)

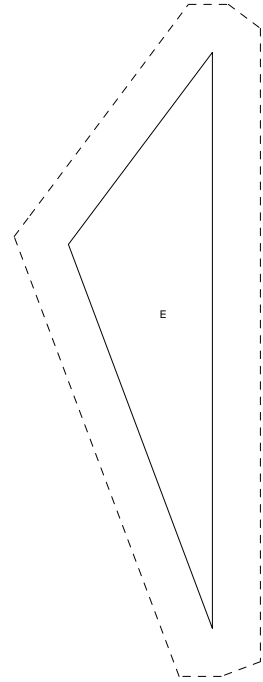
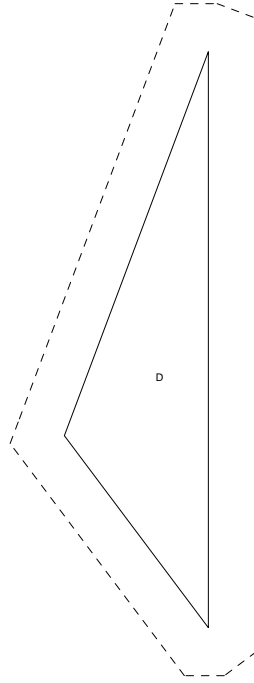
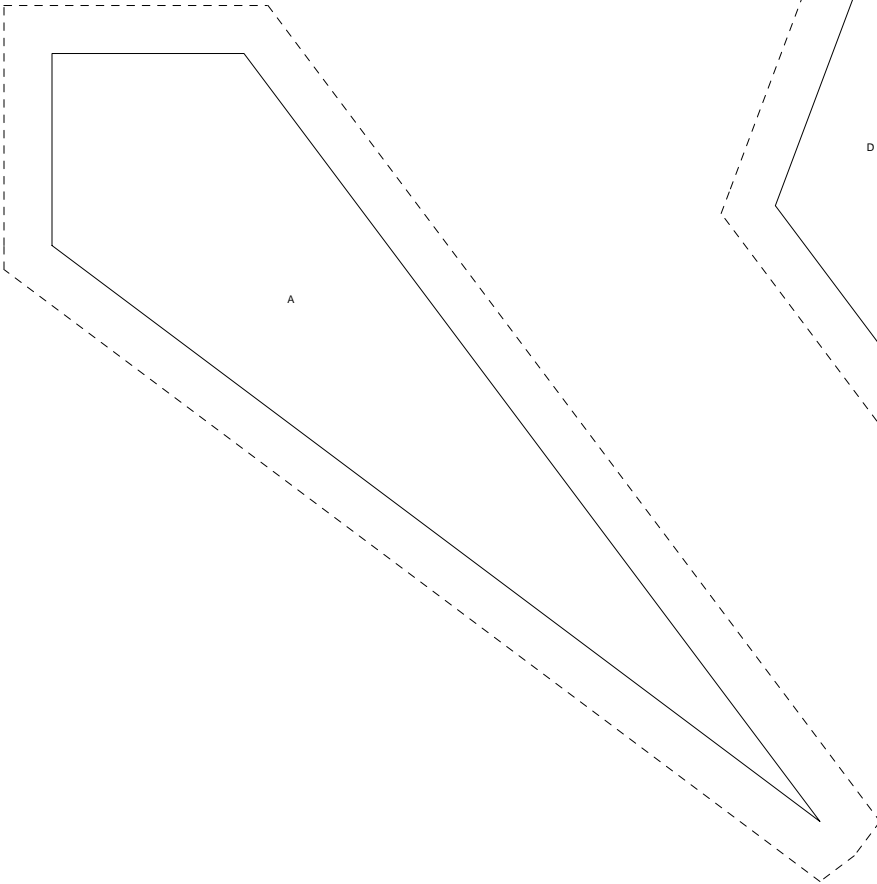
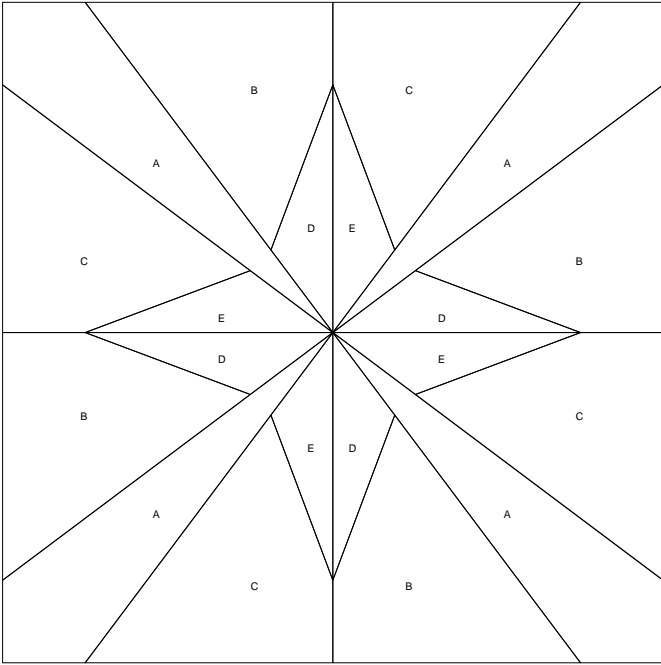

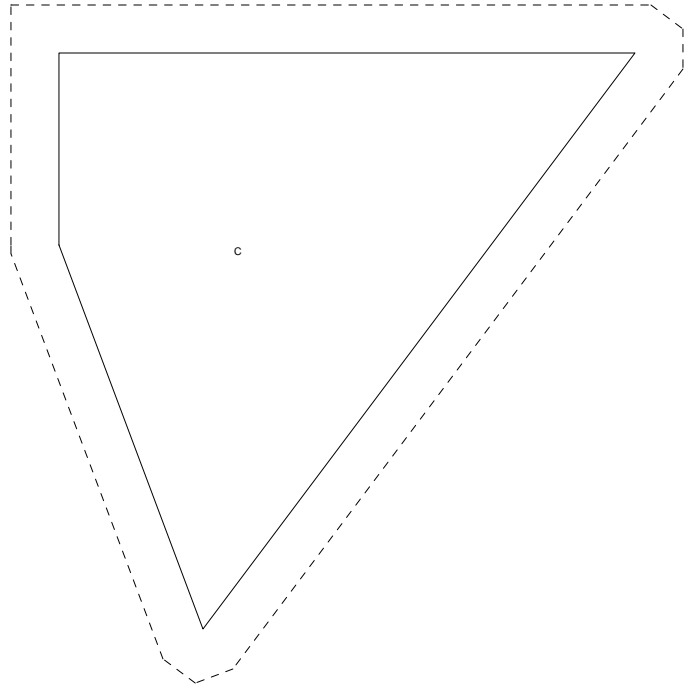
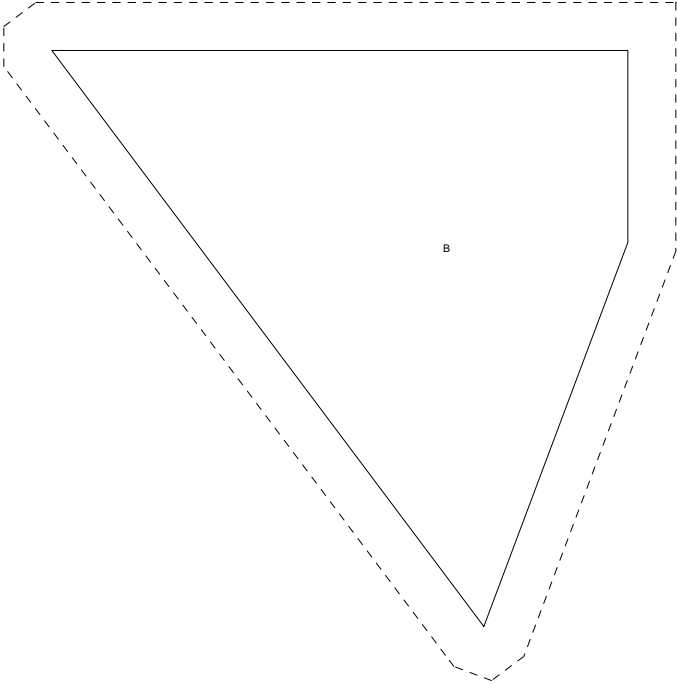

Sunshiny Day
 Pattern for 8.00x8.00 block
 Key Block (31/100 actual size)

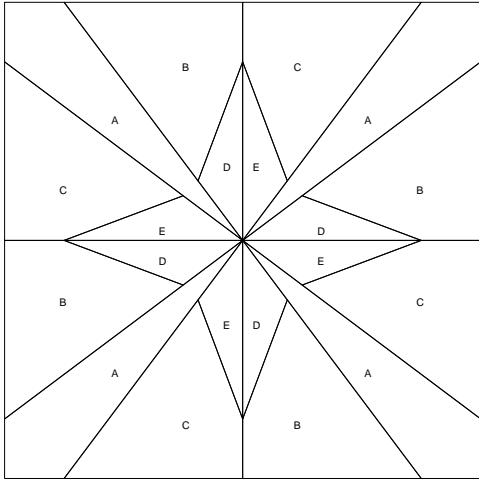

Cutting Diagrams

Patch Count

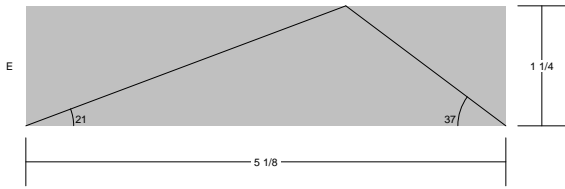
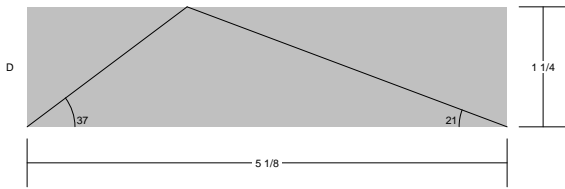

Watermelon

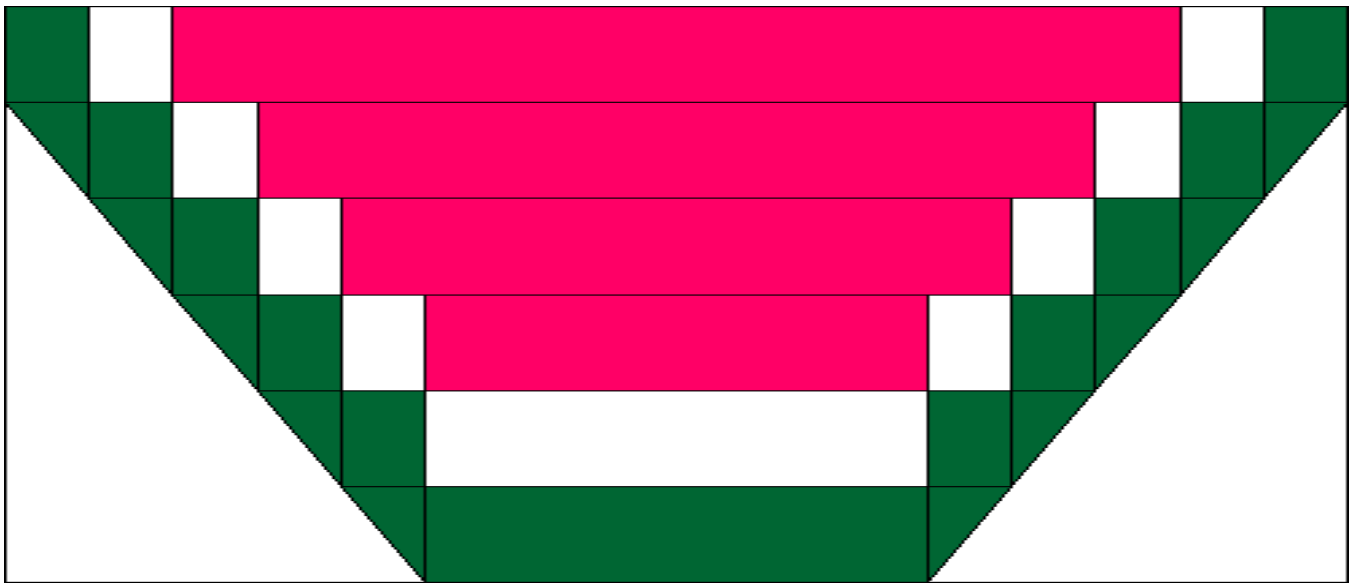

Watermelon
 Pattern for 14.00x6.00 block
 Key Block (17/100 actual size)

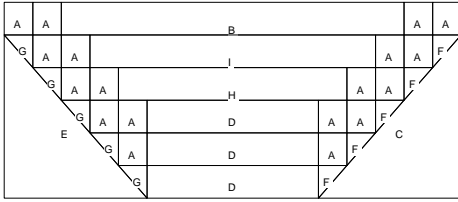

Cutting Diagrams



Patch Count

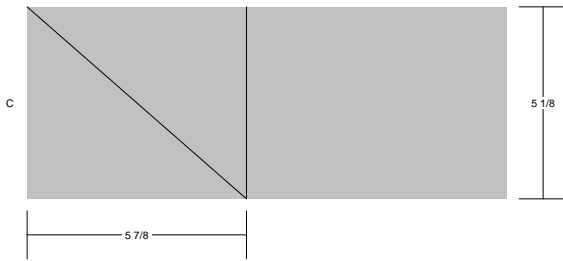
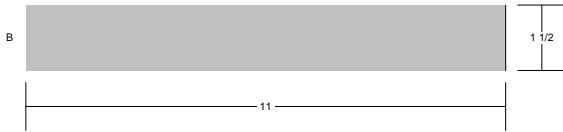

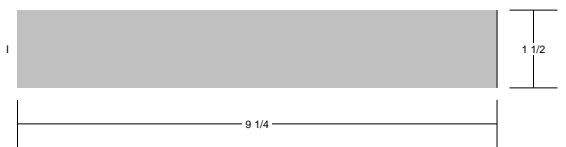
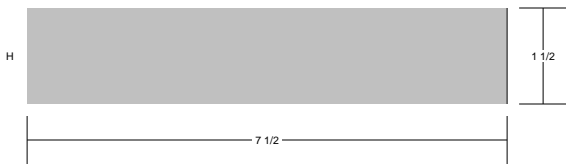
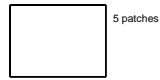
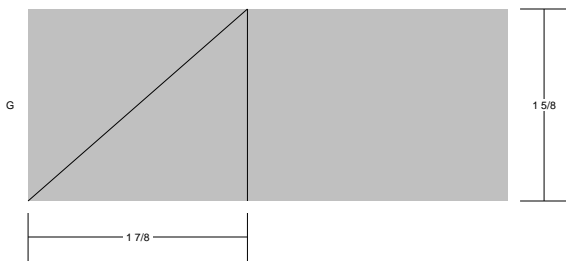
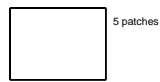
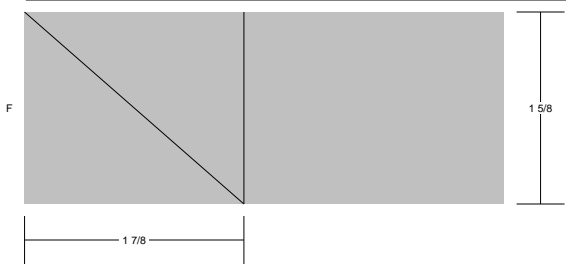
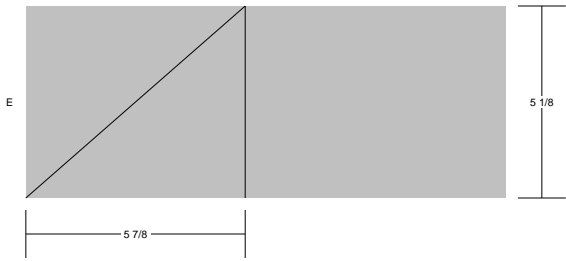
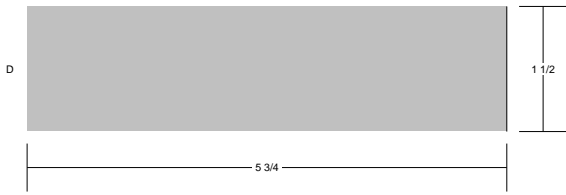

Watermelon
 Pattern for 14.00x6.00 block
 Key Block (12/50 actual size)

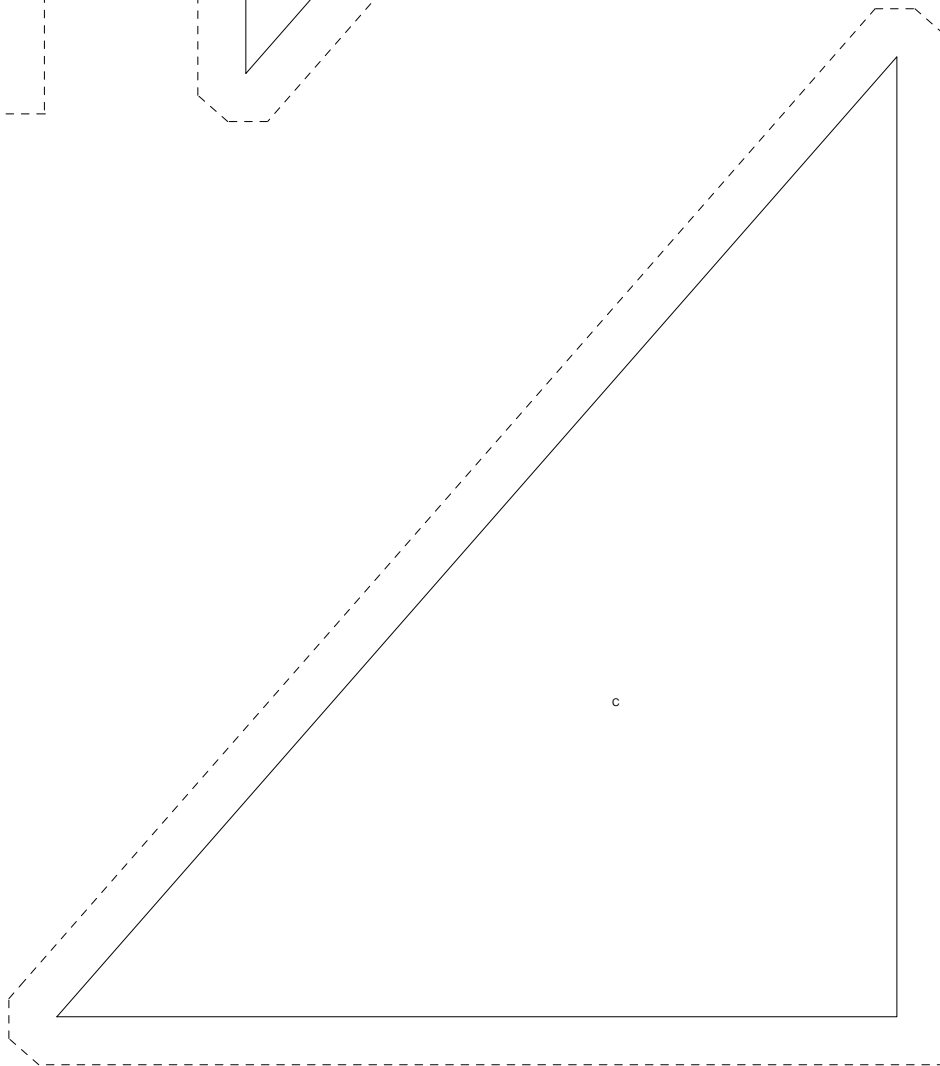
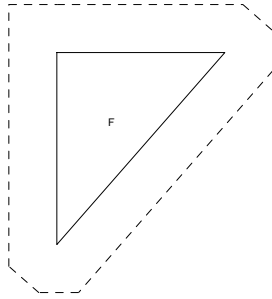
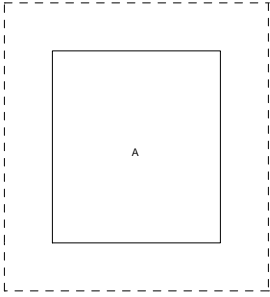
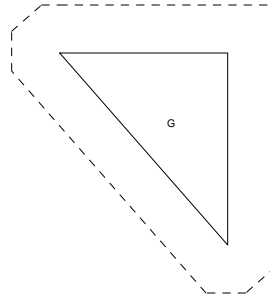
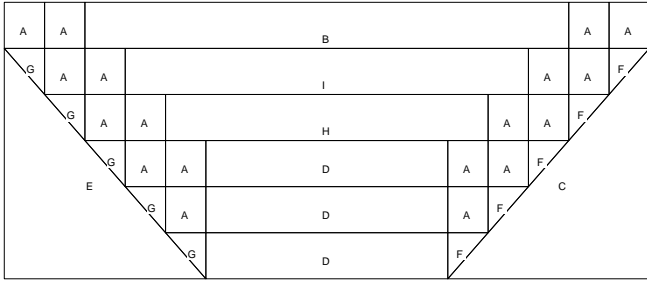

B

F

H

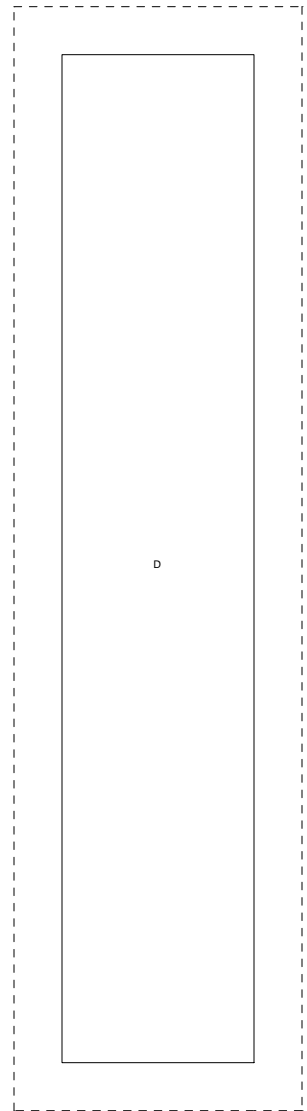
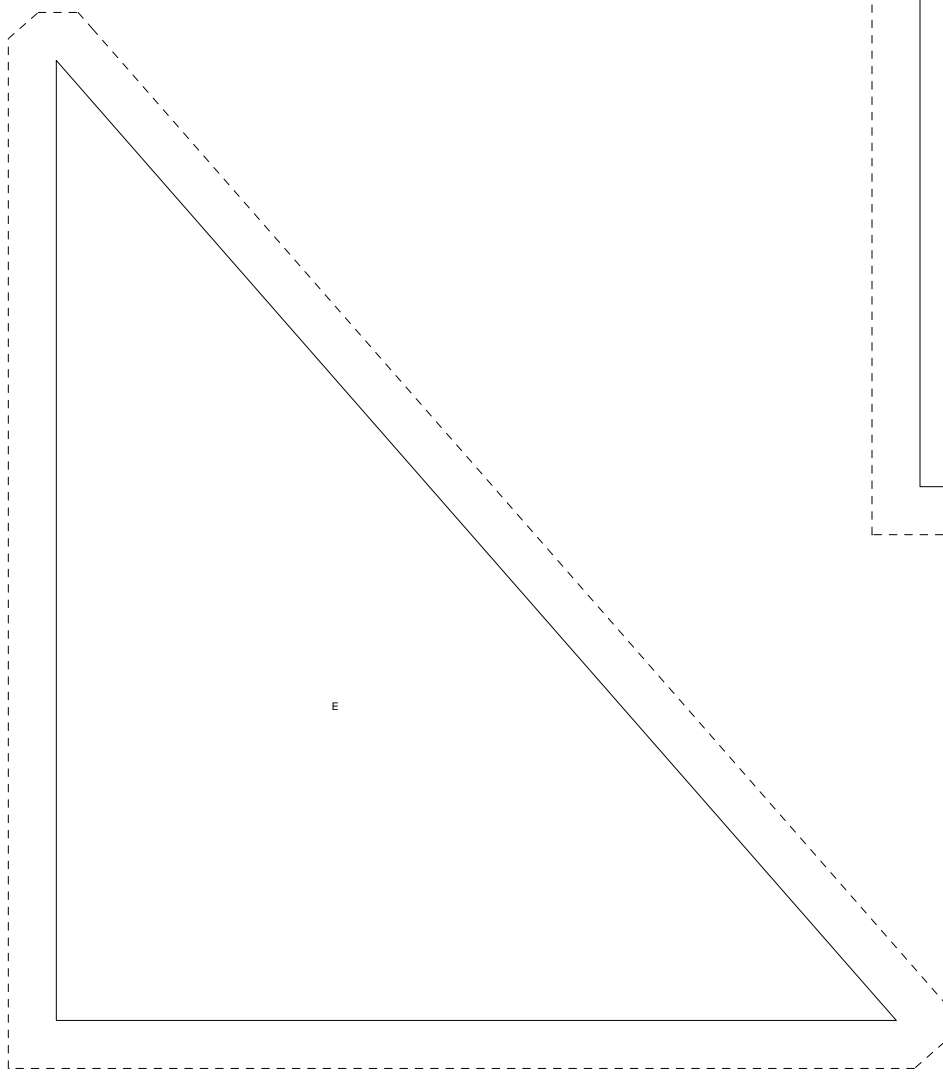

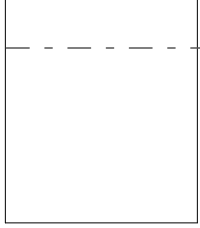

Watermelon

Watermelon Unit: D



Watermelon Unit: A



Watermelon Unit: B



Watermelon Unit: C

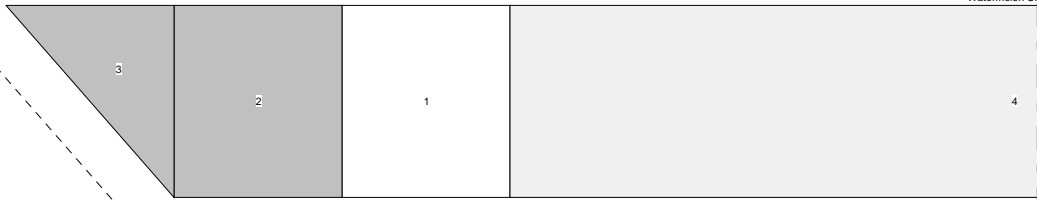

Watermelon Unit: F



Watermelon Unit: E



armelon Unitj D

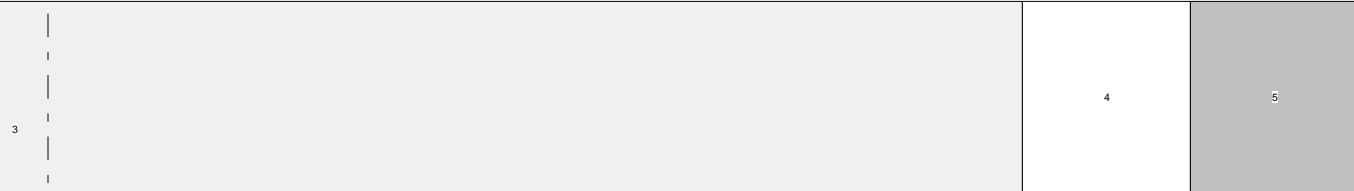

armelon Unit: A

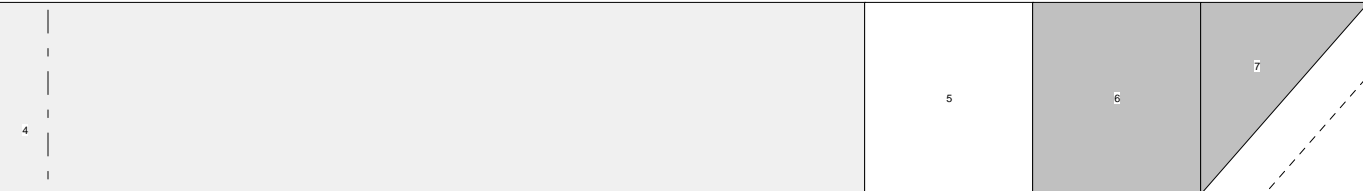

armelon Unit: B

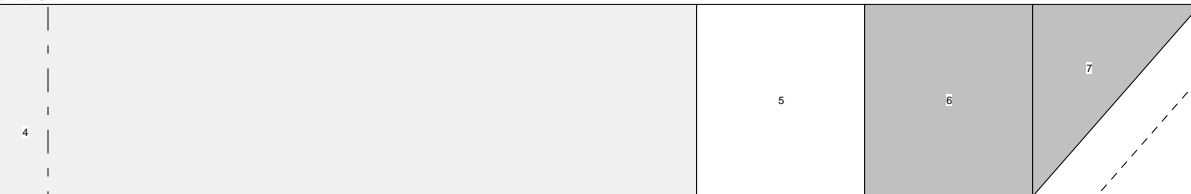

armelon Unit: C

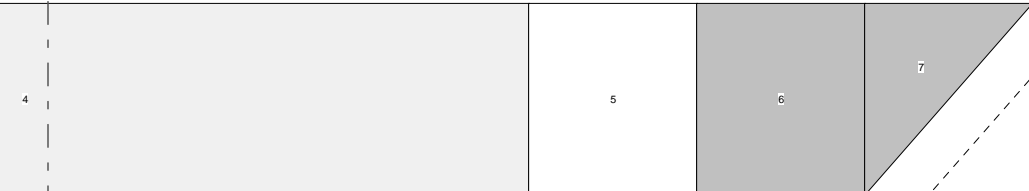

armelon Unit: F



armelon Unit: E

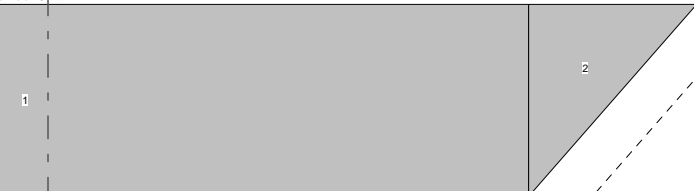

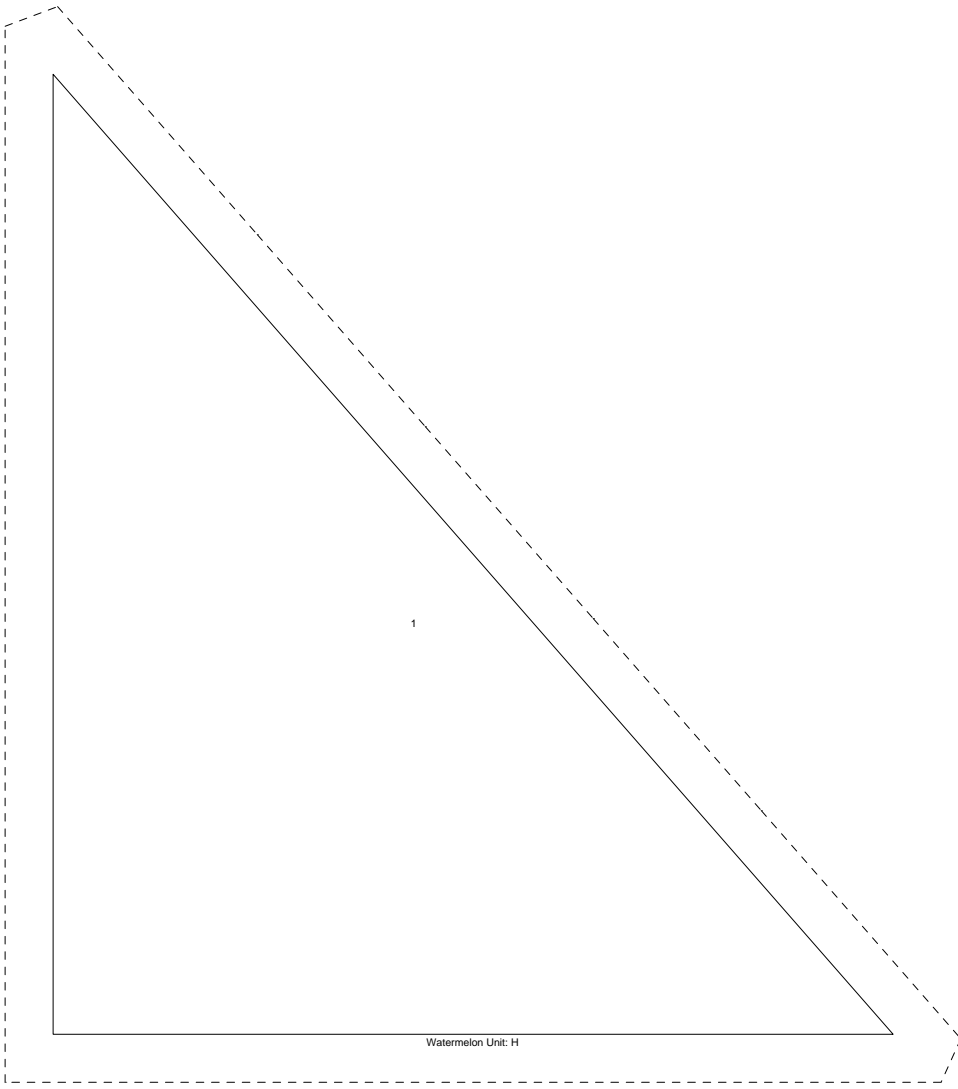

Watermelon Unit: H

1

